

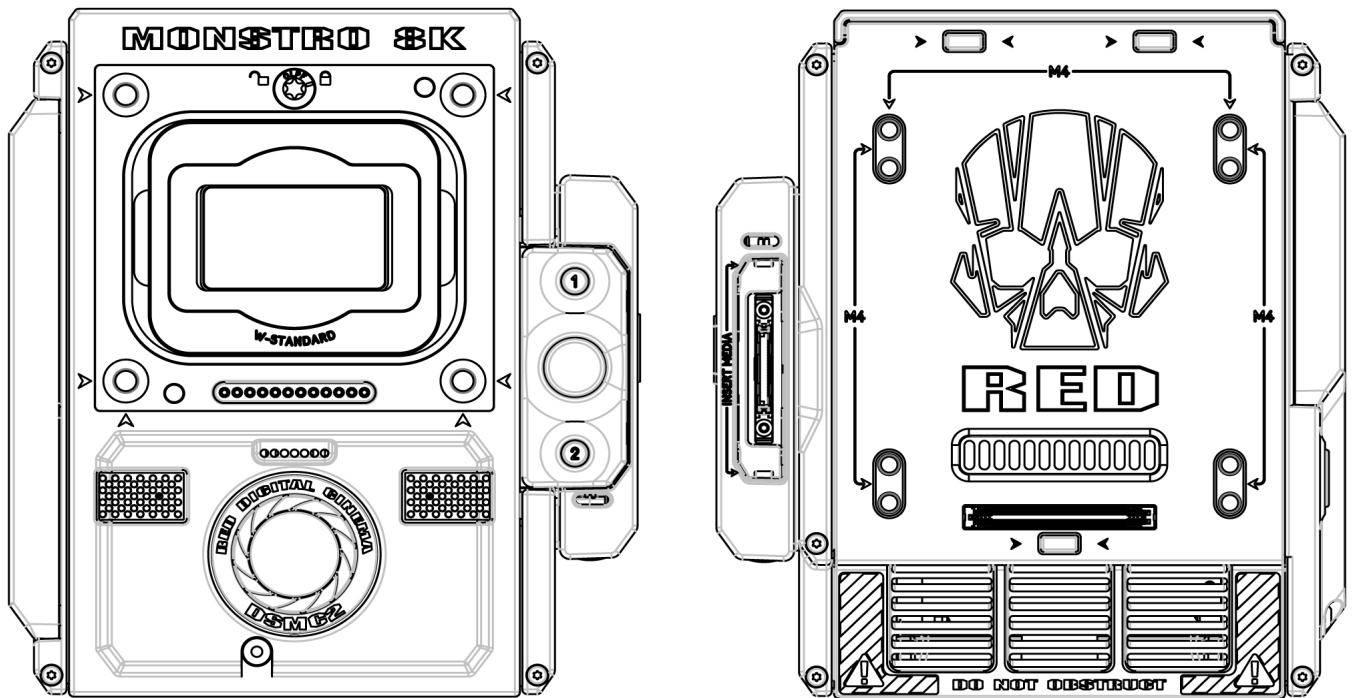

DSMC2 MONSTRO OPERATION GUIDE



MONSTRO 8K VV | MONOCHROME | V7.1

RED.COM

DSMC2 MONSTRO OPERATION GUIDE

TABLE OF CONTENTS

Table of Contents	2	Live Action Area	62
Disclaimer	4	Lower Status Row	63
Copyright Notice	4	Navigation Controls	70
Trademark Disclaimer	4	CHAPTER 5: Advanced Menus	79
Translation Disclaimer	4	Access the Advanced Menus	79
Compliance Statements	4	Image Menu	79
Safety Instructions	6	Monitoring Menu	87
Battery Storage and Handling	7	Overlays Menu	93
Shipping Disclaimer	8	Power Menu	102
CHAPTER 1: Product Introduction	9	Playback	105
Read Before You Shoot	10	Media Menu	110
R3D File Format and REDCODE	10	Presets Menu	111
Shoot For Video and Stills	10	Settings Menu	114
Post Production	11	CHAPTER 6: Sensor Calibration	159
Post Production with REDCINE-X PRO	11	When to Calibrate Sensor	159
HDRX and MAGIC MOTION	12	Calibrate Sensor: Manual Calibration	160
Additional Resources	12	Calibrate Sensor: Auto Calibration	161
CHAPTER 2: Camera System Components 13		Calibration Map Naming Conventions	162
Additional Resources	13	Calibration Management	162
BRAIN	13	Calibration Map Actions	162
RED MINI-MAG System	18	Export and Import Calibration Maps	163
Expanders	19	CHAPTER 7: Audio System	164
DSMC2 Power Modules	25	Audio Overview	164
RED Batteries and Chargers	29	Set Up Audio	164
Displays and Electronic Viewfinders	30	Control	165
LCD/EVF Adaptors	35	Mix	168
Camera Control Modules	36	Audio Output Options	168
Lens Mounts	41	Audio Meter (VU Meter)	168
Interchangeable OLPFs	42	Audio During Playback	169
Rails, Mounts, Tactical Gear, and Cables	42	Record Audio in Varispeed Mode	170
CHAPTER 3: Basic Operations	44	CHAPTER 8: Timecode, Genlock, Multi-Camera Setup	172
Power Operations	44	Timecode	172
Configure Your Camera	47	Genlock	175
Interchangeable OLPF System	53	Master/Slave Operation	177
Use a Tripod or Monopod	54	Set Up Stereo/3D Configuration	182
Video Monitor Outputs	55	Camera Array	183
Record	56	Motion Control (MoCo)	184
CHAPTER 4: Basic Menus and Controls	58	Compatible Timecode Devices	186
GUI Menu Introduction	58	Compatible Genlock Devices	186
Upper Status Row (Basic Menu)	59		

DSMC2 MONSTRO OPERATION GUIDE

CHAPTER 9: Upgrade Camera Firmware . 187

Verify Current Camera Firmware 187

Upgrade Camera Firmware 187

CHAPTER 10: Camera System Maintenance 189

BRAIN and Accessory Exterior Surfaces 189

Clean EVF Screen 190

Clean LCD Screens 190

Water Damage 191

Adjust Back Focus 192

CHAPTER 11: Troubleshoot Your Camera 193

Perform a Stress Test 193

General Troubleshooting 193

Error Messages 200

Media Bay and RED MINI-MAG Issues 204

Back Focus Lock (Lock Sensor) 205

APPENDIX A: Technical Specifications ... 207

DSMC2 MONSTRO Technical Specifications 207

DSMC2 MONSTRO Monochrome Technical Specifications 210

APPENDIX B: Mechanical Drawings 213

DSMC2 MONSTRO 213

APPENDIX C: Input/Output Connectors .. 218

DSMC2 Base Expander 219

DSMC2 V-Lock I/O Expander 220

DSMC2 REDVOLT Expander 221

DSMC2 Jetpack Expander 222

DSMC2 Jetpack-SDI Expander 223

DSMC2 Production Module 224

DSMC2 Tactical Top Plate 225

DSMC2 Production Top Plate 225

Record/Monitor Out Ports 226

Communication Ports 229

Audio Ports 240

Power Ports 242

APPENDIX D: Lens Mounts and Lenses .. 247

Lens Mounts 247

Lenses 251

APPENDIX E: Default Key Functions 263

Default Keys 263

APPENDIX F: Menu Map 266

DSMC2 MONSTRO OPERATION GUIDE

DISCLAIMER

RED® has made every effort to provide clear and accurate information in this document, which is provided solely for the user's information. While thought to be accurate, the information in this document is provided strictly "as is" and RED will not be held responsible for issues arising from typographical errors or user's interpretation of the language used herein that is different from that intended by RED. All safety and general information is subject to change as a result of changes in local, federal or other applicable laws.

RED reserves the right to revise this document and make changes from time to time in the content hereof without obligation to notify any person of such revisions or changes. In no event shall RED, its employees or authorized agents be liable to you for any damages or losses, direct or indirect, arising from the use of any technical or operational information contained in this document.

This document was generated on 7/31/2019. To see earlier versions of this document, submit a Support ticket at <https://support.red.com>.

For comments or questions about content in this document, send a detailed email to OpsGuides@red.com.

COPYRIGHT NOTICE

COPYRIGHT© 2019 RED.COM, LLC.

All trademarks, trade names, logos, icons, images, written material, code, and product names used in association with the accompanying product are the copyrights, trademarks, or other intellectual property owned and controlled exclusively by RED.COM, LLC. For a comprehensive list, see www.red.com/trademarks.

TRADEMARK DISCLAIMER

All other company, brand, and product names are trademarks or registered trademarks of their respective holders. RED has no affiliation to, is not associated with or sponsored by, and has no express rights in third-party trademarks. Adobe and Adobe Premiere Pro are registered trademarks of Adobe Systems Incorporated. AJA is a registered trademark of AJA Video Systems, Inc. Cooke and S4/i are registered trademarks of Cooke Optics Limited. DaVinci is a registered trademark of Blackmagic Design in the U.S. and other countries. Distagon, Makro- Planar, and Otus are registered trademarks of Carl Zeiss AG. Fujinon is a registered trademark of FUJIFILM CORPORATION. HDMI is a registered trademark of HDMI Licensing LLC in the United States and other countries. Leica is a registered trademark of Leica Microsystems. Loctite is a registered trademark of Henkel AG & Company KGaA. Nikkor and Nikon are registered trademarks of Nikon Corporation. Canon is a registered trademark of Canon, U.S.A. Apple, Macintosh, Final Cut Pro, and QuickTime are registered trademarks of Apple Inc. in the U.S. and other countries. Windex is a registered trademark of S. C. Johnson & Son, Inc. Windows is a registered trademark of Microsoft Corporation. Sony is a registered trademark of Sony Corporation. TORX is a registered trademark of Acument Intellectual Properties, LLC in the United States or other countries. IOS is a registered trademark of Cisco in the U.S. and other countries. Avid is a registered trademark of Avid Technology, Inc. DaVinci Resolve is a registered trademark of Blackmagic Design in the U.S. and other countries. EDIUS Pro is a registered trademark of Grass Valley. Vegas Pro is a registered trademark of Sony Creative Software. IDX is a registered trademark of IDX Company, Ltd.

TRANSLATION DISCLAIMER

This document was originally prepared in English, and any translations are provided for convenience only. While reasonable efforts were made to provide accurate translations, RED will not be held responsible for any errors, omissions, or ambiguities.

COMPLIANCE STATEMENTS

INDUSTRIAL CANADA EMISSION COMPLIANCE STATEMENTS

This device complies with Industry Canada license-exempt RSS standards RSS 139 and RSS 210. Operation is subject to the following two conditions: (1) this device may not cause interference, and (2) this device must accept any interference, including interference that may cause undesired operation of the device.

This Class B digital apparatus complies with Canadian ICES-003.

Le présent appareil est conforme aux CNR d'Industrie Canada applicables aux appareils radio exempts de licence. L'exploitation est autorisée aux deux conditions suivantes : (1) l'appareil ne doit pas produire de brouillage, et (2) l'utilisateur de l'appareil doit accepter tout brouillage radioélectrique subi, même si le brouillage est susceptible d'en compromettre le fonctionnement. Cet appareil numérique de la classe B est conforme à la norme NMB-003 du Canada.

FEDERAL COMMUNICATIONS COMMISSION (FCC) STATEMENTS



This equipment has been tested and found to comply with the limits for a Class B digital device, pursuant to part 15 of the FCC Rules. These limits are designed to provide reasonable protection against harmful interference in a residential installation. This equipment generates, uses and can radiate radio frequency energy and, if not installed and used in accordance with the instructions, may cause harmful interference to radio communications. However, there is no guarantee that interference will not occur in a particular installation. If this equipment does cause harmful interference to radio or television reception, which can be determined by turning the equipment off and on, the user is encouraged to try to correct the interference by one or more of the following measures:

- ▶ Reorient or relocate the receiving antenna.
- ▶ Increase the separation between the equipment and receiver.
- ▶ Connect the equipment into an outlet on a circuit different from that to which the receiver is connected.
- ▶ Consult the dealer or an experienced radio/TV technician for help.

In order to maintain compliance with FCC regulations, shielded cables must be used with this equipment. Operation with non-approved equipment or unshielded cables is likely to result in interference to radio and TV reception. The user is cautioned that changes and modifications made to the equipment without the approval of manufacturer could void the users authority to operate this equipment.

NOTE: This device complies with Part 15 of the FCC Rules.

Operations subjected to the following two conditions (1) this device may not cause harmful interference, and (2) this device must accept any interference received, including that may cause undesirable interference.

DSMC2 MONSTRO OPERATION GUIDE



CAUTION: Exposure to Radio Frequency Radiation.

The device shall be used in such a manner that the potential for human contact is minimized.

This equipment complies with FCC radiation exposure limits set forth for an uncontrolled environment. This equipment should be installed and operated with a minimum distance of 20 cm between the radiator and your body.



CAUTION: Regulations of the FCC and FAA prohibit airborne operation of radio-frequency wireless devices because their signals could interfere with critical aircraft instruments.



CAUTION: If the device is changed or modified without permission from RED, the user may void his or her authority to operate the equipment.

AUSTRALIA AND NEW ZEALAND STATEMENTS

RED declares that the radio equipment described in this document comply with the following international standards.

- ▶ IEC 60065 – Product Safety
- ▶ ETSI EN 300 328 – Technical requirement for radio equipment

RED declares digital devices described in this document comply with the following Australian and New Zealand standards.

- ▶ AS/NZS CISPR 22 – Electromagnetic Interference
- ▶ AS/NZS 61000.3.2 – Power Line Harmonics
- ▶ AS/NZS 61000.3.3 – Power Line Flicker

JAPAN STATEMENTS



This is a Class B product based on the standard of the Voluntary Control Council for Interference (VCCI) for information technology equipment. If this equipment is used near a radio or television receiver in a domestic environment, it may cause radio interference. Install and use the equipment according to the instruction manual.

本機器は、情報処理装置等電波障害自主規制協議会(VCCI)の基準に基づくクラスB情報技術装置です。この装置は家庭環境で使用することを目的としていますが、ラジオやテレビジョン受信機に近接して使用されると、受信障害を引き起こすことがあります。取扱説明書に従って正しい取り扱いをしてください。

GITEKI CERTIFICATION

This equipment contains specified radio equipment that has been certified to the Technical Regulation Conformity Certification under the Radio Law.

本機器は、電波法に基づく技術基準適合証明等を受けた特定無線デバイスを使用しております。



EUROPEAN UNION COMPLIANCE STATEMENTS



RED declares that the radio equipment described in this document comply with the R&TTE Directive (1999/5/EC) issued by the Commission of the European Community.

Compliance with this directive implies conformity to the following European Norms (in brackets are the equivalent international standards).

- ▶ EN 60065 (IEC 60065) – Product Safety
- ▶ ETSI EN 300 328 Technical requirement for radio equipment
- ▶ ETSI EN 301 489 General EMC requirements for radio equipment.

INFORMATION

Products with the CE marking comply with the EMC Directive (2004/108/EC) and the Low Voltage Directive (2006/95/EC) issued by the Commission of the European Community. Compliance with these directives implies conformity to the following European Product Family Standards.

- ▶ EN 55022 (CISPR 22) – Electromagnetic Interference
- ▶ EN 55024-1 (CISPR 24) – Electromagnetic Immunity
- ▶ EN 61000-3-2 (IEC61000-3-2) – Power Line Harmonics
- ▶ EN 61000-3-3 (IEC61000) – Power Line Flicker
- ▶ EN 60065 (IEC60065) – Product Safety

WASTE ELECTRICAL AND ELECTRONIC EQUIPMENT (WEEE)



The Waste Electrical and Electronic Equipment (WEEE) mark applies only to countries within the European Union (EU) and Norway. This symbol on the product and accompanying documents means that used electrical and electronic products should not be mixed with general household waste. For proper treatment, recovery and recycling, please take this product to designated collection points where it will be accepted free of charge. Alternatively, in some countries you may be able to return your

products to your local retailer upon purchase of an equivalent new product.

DSMC2 MONSTRO OPERATION GUIDE

Disposing of this product correctly will help save valuable resources and prevent any potential negative effects on human health and the environment, which could otherwise arise from inappropriate waste handling. Please contact your local authority for further details of your nearest designated collection point. Penalties may be applicable for incorrect disposal of this waste, in accordance with your national legislation.

For business users in the European Union, if you wish to discard electrical and electronic equipment, please contact your dealer or supplier for further information.

USAGE RESTRICTIONS FOR PRODUCTS THAT INCORPORATE RED COMMAND PROTOCOL



Products that fall into this category are denoted by inclusion of the Class 2 identifier symbol (exclamation mark in a circle) accompanying the CE Mark on the products regulatory label, example to the left.

FRANCE

Usage Restrictions - Geographic Area Where Restriction Applies : France

For mainland France

- ▶ 2.400 - 2.4835 GHz (Channels 1-16) authorized for indoor use
- ▶ 2.400 - 2.454 GHz (Channels 1-10) authorized for outdoor use

Restrictions d'utilisation - Zone géographique où les restrictions s'appliquent : France

Pour la France métropolitaine

- ▶ 2.400 - 2.4835 GHz (Canaux 1 à 16) autorisé en usage intérieur
- ▶ 2.400 - 2.454 GHz (Canaux 1 à 10) autorisé en usage extérieur

NORWAY

This subsection does not apply for the geographical area within a radius of 20 km from the centre of Ny-Ålesund

Dette gjelder ikke for det geografiske området innenfor en radius av 20 km fra sentrum av Ny-Ålesund

RESPONSIBLE PARTY

RED Digital Cinema

34 Parker

Irvine, CA 92618

USA

SAFETY INSTRUCTIONS

- ▶ DO NOT use the camera or accessories near water. Avoid exposing your camera to moisture. The unit is not waterproof, so contact with water could cause permanent damage to the unit as well as electric shock and serious injury to the user. DO NOT use the camera in the rain or under other conditions with high moisture without appropriate protection, and immediately remove power source if camera or accessories are exposed to moisture.



WARNING: To reduce the risk of fire or electric shock, do not expose the camera to rain or moisture.

- ▶ DO NOT expose the camera to laser beams, as laser beams may damage the sensor.
- ▶ DO NOT expose your camera to excessive vibration or impact (shock). Be careful not to drop your camera. Internal mechanisms may be damaged by severe shock. Mechanical alignment of optical elements may be affected by excessive vibration.
- ▶ ELECTROMAGNETIC INTERFERENCE: The use of devices using radio or other communication waves may result in the malfunction or interference with the unit and/or with audio and video signals.
- ▶ Clean only using a dry cloth. When cleaning your camera, remember that it is not waterproof and moisture can damage electronic circuitry. DO NOT rinse or immerse any element of the camera, lens or other accessory, keep them dry at all times. DO NOT use soaps, detergents, ammonia, alkaline cleaners, and abrasive cleaning compounds or solvents. These substances may damage lens coatings and electronic circuitry.
- ▶ Maintain sufficient ventilation—DO NOT block any ventilation openings or obstruct cooling fan airflow.



CAUTION: Proper camera ventilation requires a minimum 0.5" (1.25 cm) clearance between the camera ventilation openings and external surfaces. Verify that objects that can block the fan intake and exhaust ports do not impede airflow. Failure to permit adequate airflow may result in overheating of the camera, degraded operation and in extreme situations, damage to the camera.

DSMC2 MONSTRO OPERATION GUIDE

- ▶ DO NOT operate or store near any heat sources such as radiators, heat registers, stoves, or any other apparatus that produce heat. Store in a protected, level and ventilated place. Avoid exposure to temperature extremes, damp, severe vibration, strong magnetic fields, direct sunlight or local heat sources during storage. Remove any batteries from the camera before storage. Recommended storage and usage temperatures for your camera, lenses and other accessories are:
 - ▶ Operating range: 0°C to 40°C (32°F to 104°F)
 - ▶ Storage range: -20°C to 50°C (-4°F to 122°F)
- ▶ If there are any performance issues with your camera or accessories when operating within this temperature range, submit a Support ticket at <https://support.red.com>.
- ▶ Modules, expanders, and lens mounts are NOT HOT SWAPPABLE, meaning you cannot remove or install these items while the camera is turned on. Before installing or removing these items, you MUST turn off the camera. Failure to do so may result in damage to the item or camera that is not covered under warranty.
- ▶ DO NOT bypass the third prong of the grounding-type plug on the power cord of the included power adaptor. A grounding-type plug has two blades and a third “grounding” prong. The third prong is provided for your safety. A grounding-type plug shall be connected to an outlet with a protective earthen connection. If the grounding-type plug does not fit into your outlet, do not attempt to modify the plug or outlet, consult a qualified electrician.
- ▶ Protect all power cords from being pinched, walked on or driven over by a vehicle. Replace any power cords suspected of sustaining damage due to crushing or other forms physical damage.



Products marked with this symbol are class 2 devices. These devices are not provided with a grounding type plug.



CAUTION: The power cord plug for the included power adaptor is used as the power disconnect. To disconnect all power from the power adaptor, unplug the power cord plug from the wall outlet. During use, the power cord plug should remain easily accessible at all times.

- ▶ Lithium-ion batteries may be subject to special handling requirements pursuant to federal and local laws. Refer to specific shipping instructions included with your battery regarding proper transport of your battery. Do not handle your battery if it is damaged or leaking. Disposal of batteries must be in accordance with local environmental regulations. For example, California law requires that all rechargeable batteries must be recycled by an authorized recycle center. Storing batteries fully charged or in high temperature conditions may permanently reduce the life of the battery. Available battery capacity may also be temporarily lessened after storage in low temperature conditions.



WARNING: DO NOT expose the battery to excessive heat.



WARNING: Danger of explosion if an incorrect battery is charged with the RED Charger or is used to power the camera and accessories. Replace only with the same or equivalent type battery.



CAUTION: Refer all service and repair to qualified RED service personnel. To reduce the risk of electric shock, and damage to the camera or accessories, DO NOT attempt to perform any servicing other than any procedures that are recommended in the operating instructions.



INDOOR USE ONLY: This device is designed for use indoors only.

BATTERY STORAGE AND HANDLING



WARNING: Failure to read, understand, and follow these instructions may result in overheating, chemical leakage, smoke emission, fire, or other potentially harmful results.

- ▶ Always follow proper battery handling and storage practices. Improper handling and/or failure to abide by proper storage instructions may cause permanent damage to batteries, or degrade battery charge holding capacity. Improper handling practices or failure to comply with instructions may also put you at risk.
- ▶ Lithium-Ion batteries, like the REDVOLT®, REDVOLT-V, REDVOLT XL, and RED BRICK®, self-discharge over time. When storing for long periods of time, store batteries separately from the camera or charger and remember to charge batteries to a capacity level of 40% to 60%. If batteries will be stored for long periods of time, RED recommends that you check the charge level at least once every six (6) months, and recharge batteries to a capacity level of 40% to 60%.
- ▶ When not in use, remove the battery from the camera or charger and store the battery in a cool, dry place. Avoid extreme hot temperatures (such as inside a hot car), corrosive gas, and direct sunlight. The optimal storage temperature for batteries is between -20°C to 20°C (-4°F to 68°F).

DSMC2 MONSTRO OPERATION GUIDE



WARNING: Batteries stored in a discharged state for long periods of time may self-discharge and lose the ability to hold a charge.



WARNING: If recharging operation fails to complete even when a specified recharging time has elapsed, immediately stop further recharging.

- ▶ DO NOT store batteries in a fully charged state for extended periods of time.
- ▶ DO NOT store batteries in a fully discharged state for extended periods of time.
- ▶ DO NOT store batteries in the camera, in a camera module, or in a charger for extended periods of time.
- ▶ DO NOT use batteries for purposes other than their intended use.
- ▶ DO NOT store batteries in extreme hot or cold temperatures.
- ▶ DO NOT store batteries in direct sunlight.
- ▶ DO NOT use third-party chargers with your RED batteries.
- ▶ DO NOT disassemble or modify the battery.
- ▶ DO NOT overcharge batteries. Overcharging may increase internal temperature beyond the recommended limits and cause permanent damage to the battery.
- ▶ DO NOT connect the positive (+) and negative (-) terminals to a metal object such as a wire.
- ▶ DO NOT transport or store the battery together with metal objects such as jewelry, hairpins, etc. as they may generate heat if they come into contact with the battery.
- ▶ DO NOT discard the battery into fire or heat.
- ▶ DO NOT store, use, or recharge the battery near a heat source such as a fire or a heater.
- ▶ DO NOT allow the battery to get wet.
- ▶ DO NOT pierce the battery with pointed or other sharp objects.
- ▶ DO NOT step on, throw, or strike the battery with a hammer.
- ▶ DO NOT use a battery that appears to be deformed or damaged.
- ▶ DO NOT directly solder the battery.
- ▶ DO NOT put the battery into a microwave oven or a pressurized container.
- ▶ DO NOT use or subject the battery to intense sunlight or hot temperatures such as in a car in hot weather.
- ▶ DO NOT use it in a location where static electricity may be present.
- ▶ DO NOT exceed the recharging temperature range of 0°C to 40°C (32°F to 104°F).
- ▶ RED recommends that you only use RED chargers to recharge RED batteries.
- ▶ Store the battery in a location where children cannot reach it.
- ▶ If the battery leaks or gives off a bad odor, discontinue use immediately.

- ▶ If the battery gives off an odor, generates heat, becomes discolored or deformed, or in any way appears abnormal during use, recharging or storage, immediately remove it from the equipment or battery charger and discontinue use.
- ▶ If electrolyte begins leaking from the battery and comes into contact with your skin or clothing, immediately wash it away with running water. Failure to do this may result in skin inflammation.
- ▶ If the battery leaks and the electrolyte reaches the eyes, do not rub them. Instead, rinse the eyes with clean running water and immediately seek medical attention. Failure to do this may result in eye injury.
- ▶ If you find discoloration, a bad odor due to leakage, overheating and/or other irregularities when using the battery for the first time, submit a Support ticket at <https://support.red.com>.



NOTE: For more information regarding RED battery charging and instructions for care, refer to our [Terms and Conditions](#).

SHIPPING DISCLAIMER

Shipment of Lithium Ion cells and batteries is subject to national and international shipping requirements. A Class 9 Certified shipper is required to transport these products within the United States. REDVOLT, REDVOLT-V, REDVOLT XL, and RED BRICK batteries are considered Dangerous Goods. Other products such as REDVOLT AA and RED Li 7.2V batteries may also be classified as Dangerous Goods when purchased in bulk. Applicable laws prohibit the shipping of batteries that are physically damaged. We urge you to look into the formal rules and regulations of shipping Class 9 Dangerous Goods prior to preparing your shipment. For more information on these regulations, visit www.iata.org and www.dot.gov.

For more information, see our FAQs for [Dangerous Goods \(Regulated Items\)](#).

CHAPTER 1: PRODUCT INTRODUCTION



Figure: DSMC2 MONSTRO with DSMC VV PL Mount

As a member of the DSMC2[®] camera lineup, the DSMC2 MONSTRO[®] benefits from the advanced modularity of the RED ecosystem. The camera features cable-free peripherals, integrated mounting plate, wireless control, and compatibility with a growing number of DSMC2 modules and accessories. The DSMC2 MONSTRO also supports interchangeable OLPFs and lens mounts—empowering you to make the most of all of your compatible lenses.

This section introduces the imaging capabilities and advanced features of the camera system. For information about other cameras, go to [RED Downloads](http://www.red.com/downloads) at www.red.com/downloads.

This guide is for the following cameras only:

SENSOR TYPE	CAMERA
MONSTRO 8K VV	DSMC2 MONSTRO
	DSMC2 MONSTRO Monochrome

NOTE: The camera itself does not have a DC IN power port. A port expander or power module is required to power the camera. To construct a working configuration for any camera, RED recommends an expander, battery, lens mount, display, and media.

DSMC2 MONSTRO OPERATION GUIDE

READ BEFORE YOU SHOOT

Read this operation guide carefully and in its entirety before assembling or operating your camera or other RED accessories. In addition to this document, RED offers the following operation guides for the camera system:

- ▶ [DSMC Power Operation Guide](#)
- ▶ [DSMC Media Operation Guide](#)

To download RED operation guides, go to [RED Downloads](#) at www.red.com/downloads.

R3D FILE FORMAT AND REDCODE

All videos and frames are recorded to the R3D[®] file format. The R3D file format was developed by RED to provide an efficient and manageable RAW video data format that promotes advanced post production editing capabilities. In the R3D file format, the digital image received from the sensor is formatted as a pixel-defect corrected (but in all other aspects unprocessed) 16-bit per pixel RAW data frame. Each RAW frame, or sequence of RAW frames in a clip, is compressed using a proprietary wavelet based REDCODE[®] RAW compression, then stored to a RED MINI-MAG[®].

RAW data is recorded independently of any RGB domain color processing such as ISO, White Balance, or other RGB color space settings. Instead, color parameters are saved as reference metadata; that is, color is not burned into the recorded RAW data. This recording technique promotes flexibility in RGB color processing, which can be deferred to post production or adjusted in the field, without affecting the recorded RAW data image quality or dynamic range.

REDCODE is a visually lossless, wavelet-based compression codec that reduces R3D RAW files into a manageable size, allowing longer recording times on media. The ability to compress RAW data is one of the significant technologies that RED has brought to the industry.

For more information, see the [DSMC Media Operation Guide](#), available at www.red.com/downloads.

NOTE: REDCINE-X PRO[®] can create and export .RMD “Look” files which may then be imported as camera monitor path color processing presets. This information is stored as reference metadata, so that these color processing choices can be the default values used in post production. For more information, go to ["Looks" on page 112](#).

SHOOT FOR VIDEO AND STILLS

High resolution video, such as the digital footage captured by the camera, has surpassed the detail necessary to produce professional full-sized prints. Because of the ability to record at high frame rates and resolution, the camera is ideally suited to capture video and still images, simultaneously.

The camera is equipped with a Stills mode that makes it easier to capture stunning images. With presets optimized for stills and Swipe-Up Shortcuts for the RED Touch display, switching from Motion mode to Stills mode is seamless. Using REDCINE-X PRO, or other editing applications supporting the RED SDK, you can pull full resolution still images from R3D files.

DSMC2 MONSTRO OPERATION GUIDE

POST PRODUCTION

NOTE: Third-party applications may have limited compatibility with R3D files. Third-party developers must use the most recent **R3D SDK** to offer compatibility with the latest RED firmware.

Many non-linear editing systems (NLEs) can open and edit RED footage. Each NLE version may have specific compatibility requirements, such as camera firmware version or camera type. Before shooting, check all compatibility requirements.

The following programs can be used to open and/or edit R3D files:

- ▶ **REDCINE-X PRO:** RED's proprietary NLE. Download **REDCINE-X PRO for Windows** or **REDCINE-X PRO for Mac** from www.red.com/downloads.
- ▶ **Adobe Photoshop:** Can open .R3D files. Requires you to download the **RED Adobe Photoshop Installer for Windows** or **RED Adobe Photoshop Installer for Mac** from www.red.com/downloads.
- ▶ **Adobe Premiere Pro:** For more information on compatibility, go to the **RED Support site** at <https://support.red.com>.
- ▶ **Avid Media Composer**
- ▶ **DaVinci Resolve**
- ▶ **Edius Pro**
- ▶ **Final Cut Pro 7:** Requires you to download the **RED Apple Workflow Installer** from www.red.com/downloads.
- ▶ **Final Cut Pro X:** Requires you to download the **RED Apple Workflow Installer** from www.red.com/downloads.
- ▶ **Vegas Pro**

POST PRODUCTION WITH REDCINE-X PRO

REDCINE-X PRO is a professional one-light coloring toolset, equipped with an integrated timeline and a post effects software collection that provides the ideal environment to review recorded footage, edit metadata, organize projects, and prepare your R3D files. Use either REDCINE-X PRO or a compatible third-party non-linear editing (NLE) application to edit R3D files.

RED TETHER, included in REDCINE-X PRO, allows you to record footage from your camera directly to a computer or an external drive. Using tethering bypasses the need to record to an SSD and offload to a computer later, saving you time. The latest version of **REDCINE-X PRO for Windows**, **REDCINE-X PRO for Mac**, and the **REDCINE-X PRO Operation Guide** are available for download at **RED Downloads** at www.red.com/downloads.

NOTE: RED TETHER is included in REDCINE-X PRO build 35 or later.

NOTE: RED TETHER requires a GIG-E port, which is available on the DSMC2 Jetpack-SDI Expander, DSMC2 REDVOLT Expander, and DSMC2 Production Module. For more information, go to "**Input/Output Connectors**" on [page 218](#).

DSMC2 MONSTRO OPERATION GUIDE

HDRX AND MAGIC MOTION

HDRX

HDRX® extends dynamic range up to six (6) stops by simultaneously capturing two (2) images of identical resolution and frame rate. The first image is a normally exposed track (A-track), while the second is an underexposed track (X-track) with an exposure value that reflects the additional stops of highlight protection. These tracks are “motion-conjoined” during recording, leaving no time gap between the two (2) exposures. This is different from traditional alternating exposures, which have small gaps between tracks, producing unwanted motion tracks.

MAGIC MOTION

MAGIC MOTION is a post production method that combines two (2) HDRX tracks to create an image with both natural motion blur (from the A-track) and sharper reference (the X-track). MAGIC MOTION produces an image with an extraordinary dynamic range that is not available with any other motion capture camera.

Shooting at 24 fps with a 180° (1/48 sec) shutter on traditional film or digital cameras produces motion blur throughout, which is not the way the human eye observes motion. For example, ask someone to swing their arm. What you would observe in a traditional recording of this action is constant motion blur until the arm stops. However, what your eye sees is both motion blur and a sharper reference of the arm throughout the motion path. MAGIC MOTION creates an image that matches the natural motion observed by the human eye.

ADDITIONAL RESOURCES

The following resources offer additional information about RED, the DSMC system, and the RED community:

- ▶ **RED.com:** Check the [official RED website](#) for the latest information about RED products.
- ▶ **RED Learn Articles:** RED offers [in-depth technical articles](#) about RED cameras, post-production, and digital cinematography.
- ▶ **RED Downloads:** Go to [RED Downloads](#) to download the latest firmware, operation guides, and post-production software.
- ▶ **DSMC Toolkit:** Go to [RED Downloads](#) to find the DSMC Toolkit, which offers many helpful tools and resources to customize and improve your camera workflow.
- ▶ **RED Support:** Check the [RED SUPPORT site](#) for FAQs, or to file a support ticket.
- ▶ **In-Camera Help:** Select the Help button on an in-camera screen to open up the help for that screen.
- ▶ **REDUSER:** Discuss all things RED on the [REDUSER](#) third-party forum.

CHAPTER 2:

CAMERA SYSTEM COMPONENTS

NOTE: Modules, expanders, and lens mounts are NOT HOT SWAPPABLE, meaning you cannot remove or install these items while the camera is turned on. Before installing or removing these items, you MUST turn off the camera. Failure to do so may result in damage to the item or camera that is not covered under warranty.

NOTE: Availability of components listed in this chapter is subject to change at any time.

ADDITIONAL RESOURCES

For more information on power and media, see the following guides, available at www.red.com/downloads:

- ▶ [DSMC Power Operation Guide](#)
- ▶ [DSMC Media Operation Guide](#)

BRAIN



Figure: DSMC2 MONSTRO with DSMC VV PL Mount

The DSMC BRAIN® is the image processing center of the camera system and supports power, media, and other modules.

The only ports on the BRAIN are the DSMC2® Top Handle port and EVF/LCD ports. A port expander or power module is required to power the camera. All other input/output (I/O) ports are available only via expanders and other modules. This modular approach allows you to customize your camera and make use of the ports that are most applicable to your needs.

The RED® Tactical Hand Controller (T.H.C.) cannot pair directly to the camera. To use the T.H.C. with the camera, the T.H.C. needs to be connected to the W.M.D. (either wired or wirelessly). For more information about the T.H.C., see the [RED 3-Axis System Operation Guide](#) at www.red.com/downloads.

DSMC2 MONSTRO OPERATION GUIDE

BRAIN CONTROL: PWR/REC KEY

- ▶ Fully press and hold the **PWR/REC** key for two (2) seconds to turn on/off.
- ▶ When the camera is on, fully press and then release the **PWR/REC** key to toggle record start/stop.

BRAIN LEDS

This section describes the LED functions for the camera.

NOTE: When the camera is powered only by battery and not AC power, the Power Status LED (PWR) on the expander or module does not turn on. To check the battery charge level, press the button on the battery.

LED	COLOR/FLASHING	DESCRIPTION
Power Status LED (PWR)	Off	Camera off
	Green	Camera on
	Amber flashing	Camera on; 5 to 10 min of battery time available
	Amber	Camera booting
	Red flashing	Camera on; < 5 min of battery time available
	Red	Camera shutting down
Record Status LED (REC)	Off	No media present
	Green	Ready to record
	Amber	Finalizing
	Red flashing (slow)	Media mounted; > 5% and ≤ 10% of media available
	Red flashing (fast)	Media mounted; ≤ 5% of media available
	Red	Recording
Power Status LED (PWR) and Record Status LED (REC)	Both green flashing	Firmware update in progress
	Both red flashing	Firmware update error

DSMC2 MONSTRO OPERATION GUIDE

BRAIN CONNECTORS, FOCUS HOOK, AND BACK FOCUS

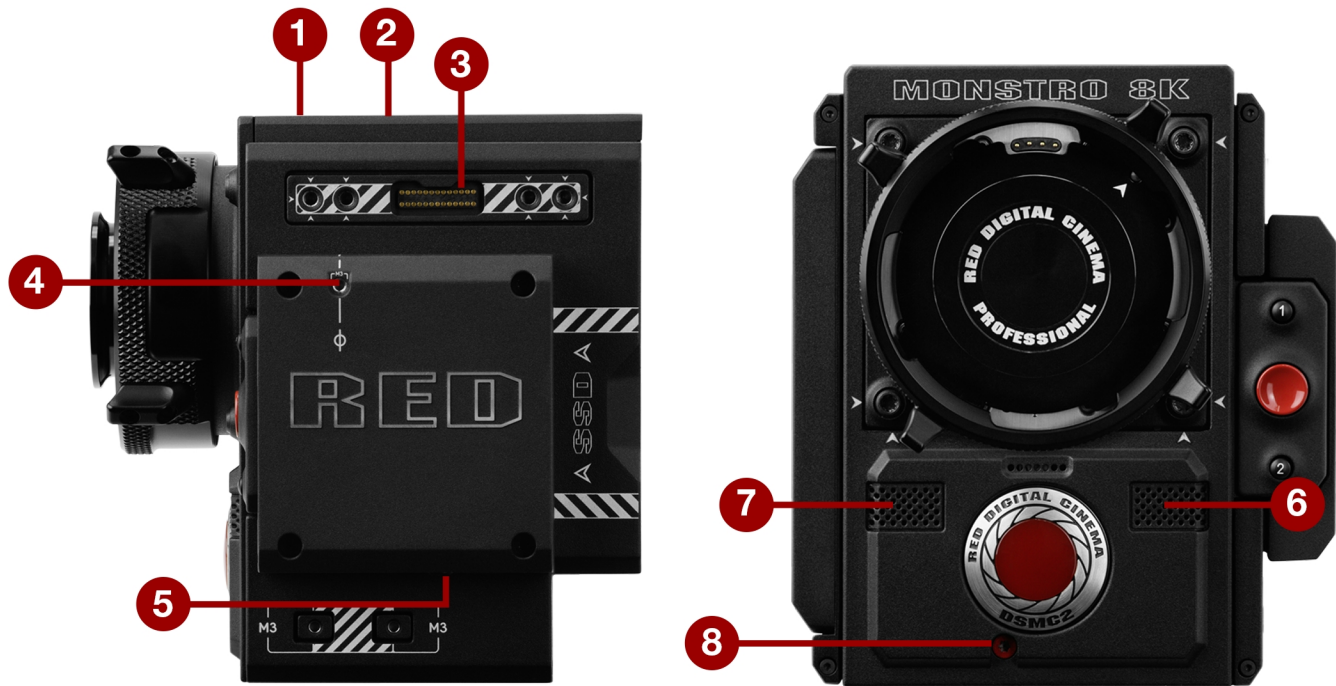

Figure: DSMC2 MONSTRO Ports and Features

#	PORT/ITEM	DESCRIPTION
1	Primary EVF/LCD Port ¹	Mount a DSMC2 RED Touch LCD
2	Top Handle Port	Mount the DSMC2 Top Handle or DSMC2 Outrigger Handle. This is the only mounting option for the DSMC2 Top Handle or DSMC2 Outrigger Handle (it cannot be attached backward)
3	Secondary EVF/LCD Port ¹	Mount a DSMC2 RED Touch LCD. The secondary LCD/EVF port and an HDM/MON-1 port cannot be used at the same time. Go to "Monitor Preferences" on page 87
4	Focus Hook Mounting Point ^{2, 3}	Mount the focus hook
5	Focus Hook Screw Storage Location ²	Store the focus hook screw
6	Mic 1	Left audio channels: Ch1 and Ch3. Go to "Audio System" on page 164
7	Mic 2	Right audio channels: Ch2 and Ch4. Go to "Audio System" on page 164
8	Back Focus Adjustment Screw	Adjust back focus

1. The DSMC2 LCD/EVF Adaptor A allows you to mount other RED® displays.
2. Install only the focus hook screw to this mounting point. Damage to the media bay or other components of the camera system caused by installing other devices is not covered under warranty.
3. Cameras manufactured before December 2017 include a set screw installed in this location. This screw can be stored in either the Focus Hook Mounting Point, or the Focus Hook Storage location.

DSMC2 MONSTRO OPERATION GUIDE

MEDIA BAY CONTROLS



Figure: DSMC2 MONSTRO Media Bay Controls

#	CONTROL	DESCRIPTION
1	User Key 1	Programmable key User Key 1 + 2 Press: Eject Media
2	REC Button	Programmable key Full Press: Record Toggle Half Press: AF Start
3	User Key 2	Programmable key User Key 1 + 2 Press: Eject Media

For more information, see the [DSMC Media Operation Guide](http://www.red.com/downloads), available at www.red.com/downloads.

DSMC2 MONSTRO OPERATION GUIDE

MEDIA BAY LEDES

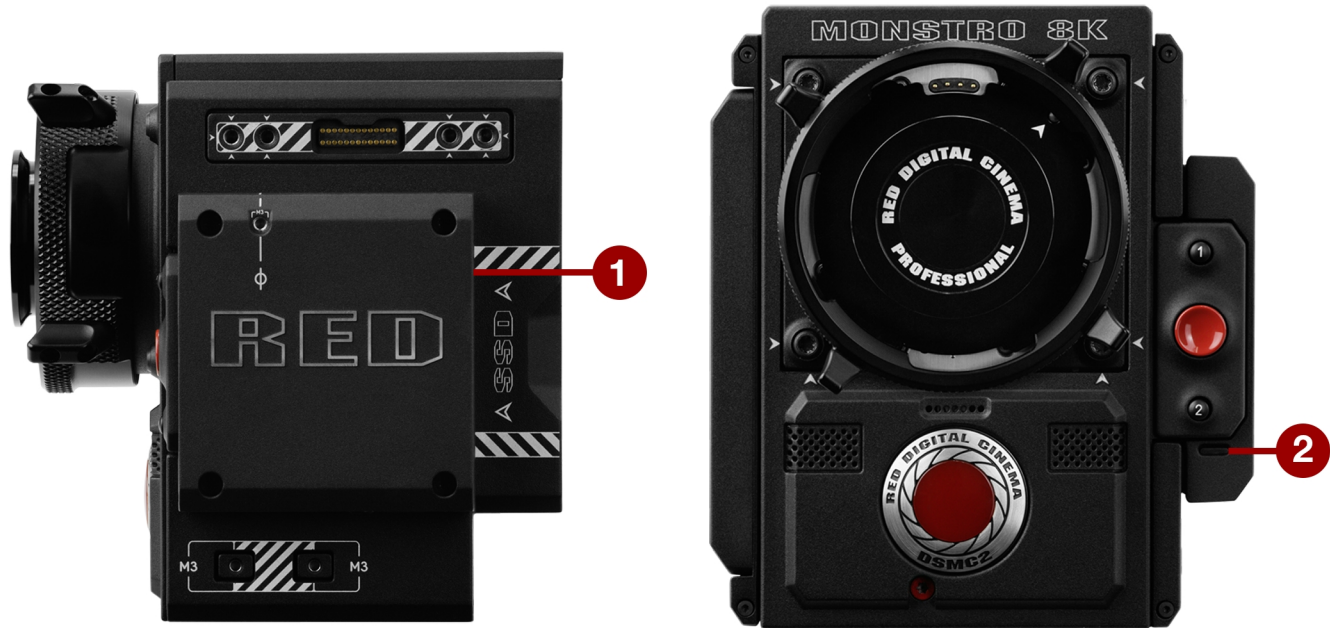

Figure: Media Bay LEDs

This section describes the LED functions for the media bay.

#	LED	COLOR/FLASHING	DESCRIPTION
1	Media Status LED (Back of media bay)	Off	No media mounted
		Green	Preview; media mounted; > 10% of media space available
		Amber	Record finalizing or playback mode
		Amber flashing (slow)	Formatting media
		Red flashing (slow)	Media mounted; > 5% and ≤ 10% of media available
		Red flashing (fast)	Media mounted; ≤ 5% of media available
		Red	Recording; media mounted; > 10% of media available
2	Record Status LED ¹	Off	Not recording, or media not mounted
		Red	Recording

1. For more information on how to enable/disable this LED, go to "Indicator" on page 135. If media is not mounted, this LED is off.

DSMC2 MONSTRO OPERATION GUIDE

RED MINI-MAG SYSTEM



Figure: RED MINI-MAG (120GB)

NOTE: For more information, see the [DSMC Media Operation Guide](http://www.red.com/downloads), available at www.red.com/downloads.

RED MINI-MAG® SSDs deliver fast and reliable recording options for your camera. A RED STATION® enables you to connect media to your computer for offloading and editing.

RED offers the following RED MINI-MAG SSDs:

ITEM	PART NUMBER
RED MINI-MAG (120GB)	750-0075
RED MINI-MAG (240GB)	750-0082
RED MINI-MAG (480GB)	750-0090
RED MINI-MAG (512GB) V4 ¹	750-0078
RED MINI-MAG (512GB) V5 ¹	750-0078
RED MINI-MAG (512GB) V6 ¹	750-0078
RED MINI-MAG (960GB)	750-0087
RED MINI-MAG (1TB) ²	750-0081

1. To see the Model number, go to **Menu > Media > Device**.
2. The RED MINI-MAG 1TB can take up to 20 seconds to mount to a computer or a camera.

DSMC2 MONSTRO OPERATION GUIDE

EXPANDERS

NOTE: Only one (1) expander module can be used at a time.

RED offers the following DSMC2 expanders:

ITEM	PART NUMBER
DSMC2 Base Expander	720-0033
DSMC2 REDVOLT Expander	720-0040
DSMC2 Jetpack Expander	720-0039
DSMC2 Jetpack-SDI Expander	720-0048
DSMC2 V-Lock I/O Expander	720-0045

DSMC2 BASE EXPANDER



Figure: DSMC2 Base Expander

The DSMC2 Base Expander is an ideal connector module for general input/output (I/O) needs. Manufactured from lightweight and durable magnesium, this low-profile module mounts directly to the BRAIN and offers interface connections for power (DC IN), HDMI, 3G-SDI (HD-SDI), CTRL and SYNC ports (for Timecode and Genlock), as well as a 3.5mm microphone input and a 3.5mm line-level headphone out.

The DSMC2 Base Expander also offers rear-mounting support for DSMC2-compatible battery and power modules, such as the DSMC2 REDVOLT® XL Module. The low profile DSMC2 Base Expander offers a variety of connectors and is ideal for run-and-gun and independent shooters.

NOTE: Only one (1) expander module can be used at a time.

DSMC2 MONSTRO OPERATION GUIDE

DSMC2 REDVOLT EXPANDER



Figure: DSMC2 REDVOLT Expander

Designed for advanced configurations, the DSMC2 REDVOLT Expander mounts directly to the camera and offers an expansive array of I/O connectors and functionality available for the camera system. The DSMC2 REDVOLT Expander features ports for power in (DC IN), Genlock (BNC), 5-Pin 0B Timecode port, GiG-E, and more. HDMI and two 3G-SDI (HD-SDI) outputs offer versatility for your video output needs, while an integrated USB power output is available to support wireless HDMI transmitters.

The DSMC2 REDVOLT Expander offers a removable audio module with two (2) standard XLR connections for most professional audio needs. Each XLR input features a 3-position selector switch to designate the incoming audio signal type: Balanced Line Level, Balanced Mic Level, and Balanced Mic with +48V phantom power. Additionally, a 3.5mm line-level headphone jack lets you sample audio during takes and in playback mode.

The DSMC2 REDVOLT Expander also provides multiple auxiliary power outputs, enabling the use of peripheral camera accessories and more:

- ▶ A rear-facing 4-Pin 0B AUX PWR port supports Start/Stop Trigger IN, Tally OUT, and provides power out up to 1.5 Amps.
- ▶ A front-facing 2-Pin 0B AUX PWR port provides 3.0A maximum.
- ▶ A front-facing 7-Pin 0B SERIAL port provides 1.5A maximum. The SERIAL port is ideal for connecting to motor drivers.
- ▶ A rear-facing Timecode port offers 5V at 200 mA for powering external timecode devices.
- ▶ A rear-facing USB port offers 5V at 1.5A for powering HDMI transmitters or small mobile devices.
- ▶ The two (2) 3-Pin XLR audio ports in the audio module each offer +48V phantom power.

For hot-swap support when it matters most, the DSMC2 REDVOLT Expander also supports a single REDVOLT battery. Additional DSMC2-compatible battery and power modules can be mounted for your changing power needs.

DSMC2 MONSTRO OPERATION GUIDE

The DSMC2 REDVOLT Expander also features a selector switch that enables the camera to automatically boot when power is provided via the DC IN connector on the expander. This feature allows you to use a connected DC input supply to turn the camera on and off when the camera is mounted in remote or difficult to maneuver locations. This expander is the ideal solution for a variety of production environments, maximizing camera interface and functionality for the most demanding shoots.

CAUTION: The mounting points on top of the DSMC2 REDVOLT Expander are designed for lightweight accessories only. DO NOT use accessories attached to the expander to pick up or move the camera.

NOTE: Only one (1) expander module can be used at a time.

DSMC2 JETPACK EXPANDER



Figure: DSMC2 Jetpack Expander

The DSMC2 Jetpack Expander is specifically designed for aerial, gimbal, handheld, and other lightweight/remote configurations. This expander features standard connectors for power (DC-IN), CTRL, and SYNC for all of your Timecode and Genlock needs. In addition, the DSMC2 Jetpack Expander offers custom-tailored support and connectors for HDMI and USB power out—perfect for housings and low-profile setups.

The DSMC2 Jetpack Expander also features a selector switch that enables the camera to automatically boot when power is provided via the DC IN connector on the expander. This feature allows you to use a connected DC input supply to turn the camera on and off when the camera is mounted in remote or difficult to maneuver locations.

NOTE: Only one (1) expander module can be used at a time.

DSMC2 MONSTRO OPERATION GUIDE

DSMC2 JETPACK-SDI EXPANDER



Figure: DSMC2 Jetpack-SDI Expander

The DSMC2 Jetpack-SDI Expander is designed for aerial, gimbal, handheld, and other lightweight/remote applications that require 3G-SDI output. Featuring connections for power (DC IN), SDI (3G-SDI), Gigabit Ethernet (GIG-E), AUX power, SYNC, and CTRL, the DSMC2 Jetpack-SDI Expander provides a low-profile expander solution. The 3G-SDI connection provides support for providing a signal to a remote monitoring solution, while the Gigabit Ethernet connection offers increased bandwidth for streaming high-quality footage. The DSMC2 Jetpack-SDI Expander is ideal for housings and low-profile configurations that require 3G-SDI outputs or computer tethering.

The DSMC2 Jetpack-SDI Expander also features a selector switch that enables the DSMC2 BRAIN to automatically boot when power is provided via the DC IN connector on the expander. This feature allows you to use a connected DC input supply to turn the BRAIN on and off when the camera is mounted in remote or difficult to maneuver locations.

NOTE: Only one (1) expander module can be used at a time.

DSMC2 MONSTRO OPERATION GUIDE

DSMC2 V-LOCK I/O EXPANDER



Figure: DSMC2 V-Lock I/O Expander

The DSMC2 V-Lock I/O Expander offers a variety of Input/Output connections, as well as an industry standard V-Lock mount to power your DSMC2 camera using RED BRICK and REDVOLT-V batteries.

The DSMC2 V-Lock I/O Expander also features a selector switch that enables the BRAIN to automatically boot when power is provided via the DC IN connector on the expander. This feature allows you to use a connected DC input supply to turn the BRAIN on and off when the camera is mounted in remote or difficult to maneuver locations.

This expander is an ideal solution for a wide variety of production environments—from low-profile run-and-gun situations to studio shoots that require mobility.

NOTE: The DSMC2 Top Handle may not be fully compatible with the DSMC2 V-Lock I/O Expander, as the top handle may interfere with the battery when one is attached to the expander module.

NOTE: Only one (1) expander module can be used at a time.

DSMC2 MONSTRO OPERATION GUIDE

THIRD-PARTY BATTERY COMPATIBILITY

To be compatible with the DSMC2 V-Lock I/O Expander, third-party batteries must meet these requirements:

- ▶ Maximum width: approximately 100.6 mm
- ▶ Minimum radius of the side edge of the V-mount (rear mounting surface): approximately 9.70 mm

The following third-party batteries have been fit-tested by RED and are mechanically compatible with the DSMC2 V-Lock I/O Expander (additional batteries may be compatible, but have not been tested):

- ▶ Blueshape® (All BV series)
- ▶ IDX® (E-HL10DS and E-HL9)
- ▶ Sony® (BP-FL75)
- ▶ Switronix (Hypercore series and XP-L90S)

WARNING: While third-party batteries may be mechanically compatible with the camera system, the manufacturer is responsible for the performance and stability of third-party options, not RED. Damage to the camera system or third-party devices caused by using third-party power options is not covered under warranty. The camera may be unable to determine and display the voltage or remaining battery capacity of third-party power options.

DSMC2 MONSTRO OPERATION GUIDE

DSMC2 POWER MODULES

ITEM	PART NUMBER
DSMC2 REDVOLT XL Module	740-0034
DSMC2 V-Lock Battery Module	720-0052
DSMC2 Gold Mount Battery Module ¹	720-0053
DSMC2 Production Module (V-Lock)	720-0054
DSMC2 Production Module (Gold Mount)	720-0056

NOTE: If a power module is attached to the DSMC2 REDVOLT Expander, the power out connectors on the module are enabled only if power is connected to the module (via DC IN or a battery).

DSMC2 REDVOLT XL MODULE



Figure: DSMC2 REDVOLT XL Module

The DSMC2 REDVOLT XL Module mounts seamlessly to the back of the camera—and select other I/O expanders—to provide support for long-lasting and rechargeable REDVOLT XL batteries. The DSMC2 REDVOLT XL Module features a smaller, more ergonomic design with one (1) dual-action release button for removing an attached battery.

The DSMC2 REDVOLT XL Module offers a DC IN power port that can be used to power the camera system when the module is attached to the camera. An included protective baseplate enables the DSMC2 REDVOLT XL Module to serve as a portable and stand-alone REDVOLT XL battery charger. Plug in the DSMC AC Power Adaptor to the 6-Pin 1B DC IN connector on the module and connect a REDVOLT XL battery. While the module is mounted to the camera, it will only charge an attached REDVOLT XL battery if the camera is powered off.

Two (2) rear facing auxiliary ports provide power for external camera accessories, while remaining out of the way while shooting.

DSMC2 MONSTRO OPERATION GUIDE

DSMC2 V-LOCK BATTERY MODULE



Figure: DSMC2 V-Lock Battery Module

The DSMC2 V-Lock Battery Module is a low profile cable-free module that enables you to power your DSMC2 BRAIN and camera accessories using RED BRICK, REDVOLT-V, or other standard V-Lock batteries. The V-Lock mount and protected release button ensure ongoing power even during mobile shoots.

This DSMC2 battery module offers a P-Tap connector on top and an auxiliary port on the side for powering peripherals and accessories. Together the P-Tap and auxiliary connectors support a maximum combined current of 3.8 Amps.

This module also offers a DC IN power port that can be used to power the camera system when the module is attached to the BRAIN. When DC IN power is supplied to the module, and the camera is turned off, this module can also trickle charge the attached V-Lock battery.

Manufactured from robust aluminum alloy, this DSMC2 battery module offers a blend of utility and power support in a lightweight and space-saving form factor. The DSMC2 V-Lock Battery Module is an ideal power solution for use with most DSMC2 expanders. Alternatively, connect the DSMC2 V-Lock Battery Module directly to your DSMC2 BRAIN for a low-profile, battery-only power configuration.

NOTE: This design of the DSMC2 V-Lock Battery Module (720-0052) replaces the earlier version of the module (720-0049), which did not have the AUX OUT and DC IN ports. All other functionality is the same.

DSMC2 MONSTRO OPERATION GUIDE

DSMC2 GOLD MOUNT BATTERY MODULE



Figure: DSMC2 Gold Mount Battery Module

The DSMC2 Gold Mount Battery Module is a low profile cable-free module that enables you to power your DSMC2 BRAIN and camera accessories using standard Gold Mount batteries. The Gold Mount and protected release button ensure ongoing power even during mobile shoots.

This DSMC2 battery module offers a P-Tap connector on top and an auxiliary port on the side for powering peripherals and accessories. Together the P-Tap and auxiliary connectors support a maximum combined current of 3.8 Amps.

This module also offers a DC IN power port that can be used to power the camera system when the module is attached to the BRAIN. When DC IN power is supplied to the module, and the camera is turned off, this module can also trickle charge a wide variety of attached Gold Mount batteries.

Manufactured from robust aluminum alloy, this DSMC2 battery module offers a blend of utility and power support in a lightweight and space-saving form factor. The DSMC2 Gold Mount Battery Module is an ideal power solution for use with most DSMC2 expanders. Alternatively, connect the DSMC2 Gold Mount Battery Module directly to your DSMC2 BRAIN for a low-profile, battery-only power configuration.

DSMC2 MONSTRO OPERATION GUIDE

DSMC2 PRODUCTION MODULE



Figure: DSMC2 Production Module (V-Lock) and DSMC2 Production Module (Gold Mount)

Designed for professional shooting configurations, the DSMC2 Production Module mounts directly to the BRAIN and offers a comprehensive array of video, power, communication, and pro audio connections. RED offers two (2) versions of this module:

- ▶ **DSMC2 Production Module (V-Lock):** Incorporates a V-Lock mount that supports the RED BRICK, REDVOLT-V, or other standard v-lock batteries.
- ▶ **DSMC2 Production Module (Gold Mount):** Incorporates a gold mount battery plate that supports standard gold mount batteries.

Aside from the battery plates, the two (2) versions of the DSMC2 Production Module are identical.

The DSMC2 Production Module is constructed from lightweight and durable aluminum alloy. The module includes three (3) BNC video connectors for maximum monitoring flexibility on-set. Two (2) connectors output a cloned 3G-SDI signal, and one (1) connector serves as an independent monitoring output.

To support production demands for on-board monitors, wireless video transmitters, wireless lens control, and focus assist systems, the module includes multiple auxiliary power outputs:

- ▶ Two (2) front-facing 3-Pin Fischer R/S ports support Remote Start/Stop functionality, and provide 24V power out up to a combined 2.5 Amps.
- ▶ A front-facing 2-Pin 0B AUX PWR port provides power out up to 3.0 Amps.
- ▶ A 2-Pin P-Tap connector on the top provides power out up to 3.0 Amps.
- ▶ A rear-facing USB 2.0 port with support for fast charging offers 5V at 1.5 Amps for powering small mobile devices.

Two (2) standard XLR connections are included for most professional audio needs. Each XLR input features a 3-position selector switch to designate the incoming audio signal type: Balanced Line Level, Balanced Mic Level, and Balanced Mic with +48V phantom power. Additionally, a 3.5mm line-level headphone jack allows users to monitor audio during takes and in playback mode.

The module features ports for power in (DC IN), Genlock (BNC), 5-Pin 0B Timecode port, GIG-E, and CTRL.

DSMC2 MONSTRO OPERATION GUIDE

The module also features a selector switch that enables the BRAIN to automatically boot when power is provided via the DC IN connector on the module. This feature allows operators to use a connected DC input supply to turn the BRAIN on and off when the camera is mounted in remote or difficult to maneuver locations.

NOTE: The battery plate on the DSMC2 Production Module is always enabled, regardless of the Auto Boot on Power switch position.

NOTE: Only one (1) module can be used at a time.

RED BATTERIES AND CHARGERS



Figure: REDVOLT XL (left) and REDVOLT (right)

The REDVOLT, REDVOLT-V, REDVOLT XL, and RED BRICK are lightweight, rechargeable lithium-ion battery cells that provide sustained power to the camera. These batteries provide long-term mobile power and attach to the camera via a power module or other RED accessory. RED chargers replenish lost capacity for REDVOLT, REDVOLT-V, REDVOLT XL, and RED BRICK batteries.

RED offers the following batteries and chargers:

ITEM	PART NUMBER
REDVOLT	740-0020
REDVOLT-V	740-0043
REDVOLT XL	740-0021
RED BRICK	740-0002
REDVOLT Travel Charger	790-0134
REDVOLT Charger (Quad)	740-0015
RED CHARGER	740-0006

For more information, see the [DSMC Power Operation Guide](#), available at www.red.com/downloads.

DSMC2 MONSTRO OPERATION GUIDE

DISPLAYS AND ELECTRONIC VIEWFINDERS

RED offers the following displays and electronic viewfinders (EVFs):

NOTE: RED offers multiple mounting solutions for each camera type.

ITEM	RESOLUTION	TILT ¹	SWIVEL ¹	PART NUMBER
DSMC2 RED Touch 7.0" LCD (Woven CF)	1920 x 1136	Total: 180° Forward: 90° Backward: 90°	Total: 360° CW: 180° CCW: 180°	730-0018
DSMC2 RED Touch 7.0" LCD (Aluminum)	1920 x 1136	Total: 180° Forward: 90° Backward: 90°	Total: 360° CW: 180° CCW: 180°	730-0024
DSMC2 RED Touch 4.7" LCD	1280 x 720	Total: 240° Forward: 90° Backward: 150°	No swivel	730-0019
RED Touch 5.0" LCD ²	800 x 400	Total: 270° Forward: 180° Backward: 90°	Total: 360° CW: 180° CCW: 180°	730-0008
RED Touch 7.0" LCD ^{2, 3}	1920 x 1136	Total: 180° Forward: 90° Backward: 90°	Total: 360° CW: 180° CCW: 180°	730-0007
RED Touch 9.0" LCD ²	1280 x 768	Total: 270° Forward: 180° Backward: 90°	Total: 360° CW: 180° CCW: 180°	730-0011
RED Pro LCD 7" ²	1024 x 600	No tilt	No swivel	730-0009
RED Pro Touch 7.0" LCD ²	1920 x 1136	No tilt	No swivel	730-0025
DSMC2 Touch 7.0" Ultra-Brite LCD ^{2, 4}	1920 x 1200	No tilt	No swivel	730-0026
DSMC2 Touch 7.0" Ultra-Brite LCD (Direct Mount) ⁴	1920 x 1200	Total: 180° Forward: 90° Backward: 90°	Total: 360° CW: 180° CCW: 180°	730-0028
DSMC2 RED EVF (OLED) ²	1920 x 1080	N/A	N/A	730-0021
BOMB EVF [®] (LCOS) ²	1280 x 784	N/A	N/A	730-0004
BOMB EVF (OLED) ²	1280 x 1024	N/A	N/A	730-0010

1. Approximate measurements.

2. Using this display with a DSMC2 camera requires a DSMC2 LCD/EVF Adaptor A, DSMC2 Tactical Top Plate, or DSMC2 Production Top Plate.

3. The RED Touch 7.0" LCD requires that your camera is on firmware v5.2.38 or later.

4. The DSMC2 Touch 7.0" Ultra-Brite LCD requires that your camera is on firmware v7.2 or later.

DSMC2 MONSTRO OPERATION GUIDE

RED LCDS



Figure: DSMC2 RED Touch 7.0" LCD

RED displays provide important camera parameters on the graphical user interface (GUI) and offer a variety of monitor viewing options. RED touchscreen displays enable you to use gestures to navigate menus and adjust camera parameters. RED displays feature 8-bit RGB, 4:4:4 progressive scan, providing up to 16.7 million colors and up to 70% NTSC color gamut (83% coverage for the DSMC2 Touch 7.0" Ultra-Brite LCD).

LCD PRECAUTIONS

WARNING: DO NOT use a RED display as a handle to lift or carry the camera. Damage to a RED display or other components of the camera system caused by using the display as a handle are not covered under warranty.

WARNING: DO NOT use the threaded holes in the RED Touch LCD base to mount the display to the camera. Damage to a RED display or other components of the camera system caused by using these threaded holes is not covered under warranty.

WARNING: DO NOT try to turn an LCD past its tilt or swivel range. Damage to a RED display or other camera components caused by excessive force is not covered under warranty. For more information on the tilt and swivel range for each display, go to ["Displays and Electronic Viewfinders" on the previous page](#).

DSMC2 MONSTRO OPERATION GUIDE

BOMB EVFS



Figure: BOMB EVF (OLED)

The BOMB EVF (LCOS) and BOMB EVF (OLED) deliver specialized viewing solutions for the camera. The BOMB EVF (LCOS) is a high-definition, lightweight, and low-profile viewfinder. The BOMB EVF (OLED) uses OLED technology, providing deeper blacks and more color accurate images.

ITEM	CONTRAST RATIO	DIOPTRER RANGE
BOMB EVF (LCOS) ¹	1000:1 typical	2.0 to -5.0.1
BOMB EVF (OLED) ¹	>10,000:1 typical	2.0 to -5.0.1

1. Using these displays with a DSMC2 camera requires a DSMC2 LCD/EVF Adaptor A.

WARNING: DO NOT point the BOMB EVF (OLED) eyepiece at direct sunlight. Continued exposure to direct sunlight may damage the EVF. Point the eyepiece away from sunlight when not in use. Damage to the BOMB EVF (OLED) caused by continued exposure to direct sunlight is not covered under warranty.

BOMB EVF FEATURES

#	FEATURE	DESCRIPTION
1	EVF Connector	Custom digital video and power interconnection between the camera and RED EVF; Pinout not published
2	EVF Tally LED	When enabled, the LED illuminates red when recording; For more information, go to "Indicator" on page 135
3	Key 1	Programmable key Magnify: Toggle
4	Key 2	Programmable key Exposure Check: Toggle
5	Eyepiece Heater	The integrated eyepiece heater automatically heats the eyepiece when the EVF detects a low ambient temperature

DSMC2 MONSTRO OPERATION GUIDE

DSMC2 RED EVF

The DSMC2 RED EVF (OLED) is a high definition electronic viewfinder designed as the ideal single-viewer monitoring solution. Featuring the latest OLED technology, this EVF provides an unmatched personal viewing experience with a 1080p OLED micro-display, and improved color accuracy with 30-bit RGB color representation. View and monitor your RED footage as it is intended with truer colors and deeper blacks in a larger field of view.

RED offers multiple mounting solutions for each camera type.

WARNING: DO NOT point the DSMC2 RED EVF (OLED) eyepiece at direct sunlight. Continued exposure to direct sunlight may damage the EVF. Point the eyepiece away from sunlight when not in use. Damage to the DSMC2 RED EVF (OLED) caused by continued exposure to direct sunlight is not covered under warranty.

NOTE: DO NOT overtighten the black tension ring on the EVF connector. The EVF is designed to allow rotation even when the tension ring is fully engaged.

DSMC2 MONSTRO OPERATION GUIDE

DSMC2 RED EVF FEATURES



Figure: DSMC2 RED EVF

#	FEATURE	DESCRIPTION
1	DSMC2 RED EVF Mount	The DSMC2 RED EVF Mount. DO NOT overtighten the black tension ring on the EVF connector. The EVF is designed to allow rotation even when the tension ring is fully engaged.
2	EVF Connector ¹	Custom digital video and power interconnection between the EVF and other RED devices; Pinout not published; compatible with standard RED LCD/EVF cables.
3	Key 1	Programmable key Magnify: Toggle
4	Key 2	Programmable key Exposure Check: Toggle
5	Mounting Point	Mounting point for the DSMC2 RED EVF Mounting Plate
6	DSMC2 RED EVF Modular Optical Block	Fully coated with a > 32° field of view

1. Not visible. Shown with the DSMC2 RED EVF Mount attached.

DSMC2 MONSTRO OPERATION GUIDE

LCD/EVF ADAPTORS

This section describes the DSMC2 LCD/EVF Adaptor A and the DSMC2 LCD/EVF Adaptor B. These adaptors enable you to use EPIC/SCARLET displays with your DSMC2 camera and use DSMC2 displays with your EPIC/SCARLET camera. For more information on available displays, go to "[Displays and Electronic Viewfinders](#)" on page 30.

ITEM	PART NUMBER
DSMC2 LCD/EVF Adaptor A	720-0037
DSMC2 LCD/EVF Adaptor B	720-0038

DSMC2 LCD/EVF ADAPTOR A



Figure: DSMC2 LCD/EVF Adaptor A

The DSMC2 LCD/EVF Adaptor A makes your existing RED Touch, RED PRO, and RED PRO Touch displays, as well as RED EVFs, fully compatible with the DSMC2 camera system. The DSMC2 LCD/EVF Adaptor A converts the pogo connection on the DSMC2 camera to a 16-Pin 1B LCD/EVF port. The DSMC2 LCD/EVF Adaptor A is designed to attach to the primary (top), or the secondary (side) EVF/LCD port on the DSMC2 camera.

When used along with the DSMC2 LCD/EVF Adaptor B, this adaptor enables you to mount a DSMC2 RED Touch LCD away from the camera—to a NOGA arm or other stable mounting point.

The DSMC2 LCD/EVF Adaptor A is compatible with the BOMB EVF, (LCOS) and (OLED) models, or later.

DSMC2 LCD/EVF ADAPTOR B



Figure: DSMC2 LCD/EVF Adaptor B

The DSMC2 LCD/EVF Adaptor B enables you to use a DSMC2 RED Touch LCD with your existing EPIC or SCARLET camera. The DSMC2 LCD/EVF Adaptor B converts the display signal from a pogo connection to a 16-Pin 1B LCD/EVF port. The DSMC2 LCD/EVF Adaptor B is designed to mount to your EPIC or SCARLET camera using standard 1/4-20 mounting holes.

When used along with the DSMC2 LCD/EVF Adaptor A, this adaptor enables you to mount a DSMC2 RED Touch LCD away from the camera—to a NOGA arm or other stable mounting point.

DSMC2 MONSTRO OPERATION GUIDE

CAMERA CONTROL MODULES

This section describes the camera control modules. These devices provide a wide array of programmable buttons, controls, and other features to interact with the camera. RED offers the following controls:

ITEM	PART NUMBER
DSMC2 SIDEKICK™ (Forged CF)	720-0041
DSMC2 SIDEKICK (Woven CF)	720-0036
DSMC2 SIDEKICK (Magnesium)	720-0032
DSMC2 Side Handle	720-0050
DSMC2 Top Handle	720-0035
DSMC2 Outrigger Handle	720-0044
DSMC2 Tactical Top Plate	790-0624
DSMC2 Production Top Plate	105-2178

DSMC2 MONSTRO OPERATION GUIDE

DSMC2 SIDEKICK



Figure: DSMC2 SIDEKICK (Woven CF)

The DSMC2 SIDEKICK is a lightweight interface solution that offers intuitive integrated control over critical camera parameters. Engineered exclusively for the DSMC2 system, this low profile interface provides full access to basic and advanced menus via a 1.7" OLED display. The rotary dial, D-Pad, function buttons, and configurable preset buttons provide an improved method of controlling your camera.

The DSMC2 SIDEKICK provides full menu control without compromising the tactical advantages of your camera's small form-factor and weight.

NOTE: The DSMC2 SIDEKICK goes into Sleep mode after 10 minutes of inactivity.

NOTE: Each DSMC2 SIDEKICK is compatible with all DSMC2 cameras.

DSMC2 MONSTRO OPERATION GUIDE

DSMC2 SIDE HANDLE



Figure: DSMC2 Side Handle

Designed for shooters who prefer a compact handheld configuration, the DSMC2 Side Handle offers the most ergonomic handle option—attaching directly to the side of the camera BRAIN.

The DSMC2 Side Handle features a molded rubber grip and puts primary camera controls right at your fingertips. The Focus Control Wheel (front) offers direct control over lens focus, while the Iris Control Wheel (side) supports iris functions. The rotary wheel and D-Pad provide advanced control over menu options directly from the handle. Four (4) customizable camera parameter buttons provide quick access to controls such as exposure, white balance, magnification toggle, and autofocus. Additionally, a stepped encoder offers additional operation customization and lets you incrementally increase or decrease the selected camera parameters.

An intelligent DSMC2 handle wouldn't be complete without a record button—allowing you to toggle record on/off directly from the handle. On top of an integrated RECORD button, the DSMC2 Side Handle features a MARK FRAME button, empowering you to tag frames while shooting and revisit them later in post production.

NOTE: The DSMC2 Side Handle cannot be used simultaneously with the DSMC2 Outrigger Handle or DSMC2 SIDEKICK.

NOTE: The DSMC2 Side Handle (with original grip) supports a maximum weight of 30 lbs when attached directly to the BRAIN. Damage to the DSMC2 Side Handle or other components of the camera system caused by using a DSMC2 Side Handle to lift a camera system that exceeds 30 lbs is not covered under warranty.

NOTE: You may replace the original grip of the DSMC2 Side Handle with a third-party grip. However, RED does not test third-party grips, and cannot confirm if the third-party device will have the same functionality, quality, or strength as the original grip included by RED in the DSMC2 Side Handle. Damage to the DSMC2 Side Handle or other components of the camera system caused by using third-party accessories is not covered under warranty.

DSMC2 MONSTRO OPERATION GUIDE

DSMC2 TOP HANDLE



Figure: DSMC2 Top Handle

Ergonomic and intuitive, the DSMC2 Top Handle was engineered entirely around the most important action for any shooter—the record button. This intelligent top handle puts a new Record Start/Stop button at your fingertips, using built-in integrated circuitry.

The DSMC2 Top Handle mounts directly to the 1/4-20 mounting points on the top of the camera. With a rubberized grip and new trigger design—the DSMC2 Top Handle offers the ideal handle and shooting method for your camera.

DSMC2 OUTRIGGER HANDLE



Figure: DSMC2 Outrigger Handle

The DSMC2 Outrigger Handle offers a low profile side handle—designed with an ergonomic molded grip and integrated Record Start/Stop button. Mounted to the Top Handle Port on your camera, the DSMC2 Outrigger Handle provides comfort and stability, as well as additional 1/4-20 mounting points for your peripheral camera components. The built-in Record button puts Start/Stop functionality right at your fingertips—so you are always ready to capture the perfect shot.

The DSMC2 Outrigger Handle is ideal for shooters who use one hand on the handle, for grip and record button access, and the other for lens adjustments or support.

DSMC2 MONSTRO OPERATION GUIDE

DSMC2 TACTICAL TOP PLATE



Figure: DSMC2 Tactical Top Plate

Machined from robust 7075 Aluminum, the DSMC2 Tactical Top Plate mounts to the top of your DSMC2 BRAIN to provide 1/4-20 and 3/8-16 mounting points for RED and third-party accessories. This plate is specifically designed to provide reliable and seamless functionality with existing DSMC2 battery modules, expanders, and accessories.

The DSMC2 Tactical Top Plate provides multiple ways to trigger record start/stop. First, the plate offers a 3-pin POGO connector that allows you to mount a RED “smart” handle, extending the DSMC2 BRAIN’s intelligent handle interface. Second, the plate also offers an unpowered 3-pin Fischer port, boasting the flexibility to interface with compatible third-party start/stop triggers.

Additionally, the DSMC2 Tactical Top Plate extends the DSMC2 BRAIN's top LCD/EVF interface through a 16-Pin 1B LCD/EVF connector. This additional connector allows you to remote mount a RED 16-Pin 1B-based display without the use of a LCD/EVF Adaptor A.

DSMC2 PRODUCTION TOP PLATE



Figure: DSMC2 Production Top Plate

Designed to pair with the DSMC2 REDVOLT Expander and DSMC2 Production Module, the DSMC2 Production Top Plate provides additional 1/4-20 and 3/8-16 mounting points for RED and third-party accessories. The DSMC2 Production Top Plate offers the same I/O as the DSMC2 Tactical Top Plate: a 3-pin POGO connector to mount a RED “smart” handle; an unpowered 3-pin Fischer port for start/stop; and a 16-Pin 1B LCD/EVF connector. The plate is compatible with other RED expanders and modules but may cover the P-Tap connector and Auto Boot on Power switch, or interfere with the use of rear-mounted batteries.

DSMC2 MONSTRO OPERATION GUIDE

LENS MOUNTS

RED offers the following lens mounts:

ITEM	PART NUMBER
DSMC VV Mg PL Mount 2.0 (Captive)	725-0031
DSMC VV Al Canon Mount (Captive)	725-0030
DSMC S35 Mg PL Mount 2.0 ¹	725-0024
DSMC S35 Ti PL Mount (Captive) ¹	725-0022
DSMC S35 Al Canon Mount (Captive) ¹	725-0026
DSMC S35 Ti Canon Mount (Captive) ¹	725-0032
DSMC S35 Al Nikon Mount ¹	725-0006
DSMC S35 Ti Nikon Mount ¹	725-0007
DSMC Al Leica M Mount (Captive) ¹	725-0029
DSMC RED MOTION MOUNT S35 Ti PL ¹	725-0012
DSMC RED MOTION MOUNT S35 Ti Canon (Captive) ¹	725-0038

1. For cameras with the MONSTRO 8K VV sensor, data still passes through the lens mount. However, the lens mount may cause a vignette when using the full area of the sensor.

DSMC2 MONSTRO OPERATION GUIDE

INTERCHANGEABLE OLPFs

The camera system includes intelligent, interchangeable optical low pass filters (OLPFs). The camera automatically recognizes the OLPF type installed, eliminating the need to configure OLPF settings in the camera menu.

RED offers the following modular VV interchangeable OLPFs:

ITEM	PART NUMBER	REQUIRED FIRMWARE
DSMC2 Standard OLPF (VV)	790-0558	v7.0.0 or later
DSMC2 Skin Tone-Highlight OLPF (VV)	790-0559	v7.0.0 or later
DSMC2 Low Light Optimized OLPF (VV)	790-0560	v7.0.0 or later
DSMC2 VV H ₂ O OLPF	790-0601	v7.0.0 or later

RAILS, MOUNTS, TACTICAL GEAR, AND CABLES

RED offers a wide variety of support gear, mounting platforms, cables, accessories, and other equipment. For more information, visit the [RED Store](http://www.red.com/store) at www.red.com/store.

CAUTION: Attach accessories, plates, and rails directly to the mounting points on the BRAIN. While the DSMC2 REDVOLT Expander has mounting points for lightweight accessories, other expanders and modules are not designed to support additional weight.

MAXIMUM SUPPORTED WEIGHTS

The table below lists the maximum weight each handle can support in specific configurations. Damage to handles or other components of the camera system caused by using a handle to lift more than the specified weight is not covered under warranty.

ITEM	PART NUMBER	CONFIGURATION	MAXIMUM SUPPORTED WEIGHT
DSMC2 Universal Handle	790-0523	Attached directly to the camera body	30 lbs
Production Handle	105-2120	One riser attached to a plate; handle extension attached	40 lbs
		Two risers attached to a plate; handle extension attached	80 lbs

DSMC2 MONSTRO OPERATION GUIDE

PRODUCTION HANDLE



Figure: Production Handle

The modular design of the Production Handle provides a configurable, rugged handle with an array of 1/4-20 and 3/8-16 mounting points for industry-standard accessories. It can be set up in a compact or extended configuration to suit various shooting needs.

The Production Handle ships with a focus hook, which can be mounted on the handle in two separate mounting points (one for DSMC2 cameras, and another for RED RANGER cameras).

CHAPTER 3: BASIC OPERATIONS

POWER OPERATIONS

This section describes the basic power operations of the camera system.

For more information, see the [DSMC Power Operation Guide](http://www.red.com/downloads), available at www.red.com/downloads.

NOTE: Modules, expanders, and lens mounts are NOT HOT SWAPPABLE, meaning you cannot remove or install these items while the camera is turned on. Before installing or removing these items, you MUST turn off the camera. Failure to do so may result in damage to the item or camera that is not covered under warranty.

WARNING: While third-party batteries may be mechanically compatible with the camera system, the manufacturer is responsible for the performance and stability of third-party options, not RED®. Damage to the camera system or third-party devices caused by using third-party power options is not covered under warranty. The camera may be unable to determine and display the voltage or remaining battery capacity of third-party power options.

POWER PRIORITY

When multiple power sources are connected to the camera, power consumption is prioritized in this sequence:

1. Any power supply connected to the DC IN port on the expander
2. Any power supply connected to the DC IN port on a rear battery module
3. Rear battery
4. REDVOLT battery in the DSMC2® REDVOLT Expander

POWER CONSUMPTION

The camera draws approximately 3.3 A (50 W) when configured with the DSMC2 Base Expander, DSMC2 RED Touch 7.0" LCD, and RED MINI-MAG® 512GB.

Under typical conditions batteries provide the following operating time:

- ▶ **REDVOLT:** Powers the camera and accessories for approximately 30 minutes.
- ▶ **REDVOLT-V:** Powers the camera and accessories for approximately 35 minutes.
- ▶ **REDVOLT XL:** Powers the camera and accessories for approximately 90 minutes.
- ▶ **RED BRICK:** Powers the camera and accessories for approximately 120 minutes.

POWER STATUS

The power status of the current primary power source displays in the Lower Status Row of the graphical user interface (GUI). Navigate to the Power In menu at **Menu > Power > Power In** for the status of all connected power sources. For more information, go to "[Power Menu](#)" on page 102.

DSMC2 MONSTRO OPERATION GUIDE

APPROVED EXTERNAL DC POWER

The DSMC2 cameras accept input voltages of 11.5 V DC to 17 V DC, and can draw a maximum current of 9A. The camera can be powered continuously by connecting one (1) of the following to an attached module or expander:

- ▶ **DSMC AC Power Adaptor**
- ▶ **RED BRICK Charger:** Offers two (2) ways to connect to your camera:
 - ▶ Use a RED ONE DC Power Cable (P/N 790-0060) and a 2B-to-1B Power Adaptor Cable (P/N 790-0138).
 - ▶ Use a RED 2B-to-1B Power Cable (P/N 790-0556, 790-0654).
- ▶ **RED BRICK:** Requires a DSMC2 V-Lock I/O Expander, Battery Belt Clip (DSMC), or DSMC2 V-Lock Battery Module. Also supported by a RED Quickplate or RED Cradle using a 2B-to-1B Power Adaptor Cable.
- ▶ **REDVOLT-V:** Requires a DSMC2 V-Lock I/O Expander, Battery Belt Clip (DSMC), or DSMC2 V-Lock Battery Module. Also supported by a RED Quickplate or RED Cradle using a 2B-to-1B Power Adaptor Cable.
- ▶ **XLR DC power source:** Requires an XLR Power Cable.

WARNING: While third-party batteries may be mechanically compatible with the camera system, the manufacturer is responsible for the performance and stability of third-party options, not RED. Damage to the camera system or third-party devices caused by using third-party power options is not covered under warranty. The camera may be unable to determine and display the voltage or remaining battery capacity of third-party power options.

TURN ON THE CAMERA

NOTE: If you have just turned off the camera, wait at least three (3) seconds before turning the camera back on.

1. Attach a power source to the camera.
2. Press and release the **PWR/REC** key on the right side of the camera.
 - The Power Status LED illuminates amber as the camera turns on.
 - The Power Status LED illuminates green to confirm that the camera is turned on and ready to use.

TURN OFF THE CAMERA

Use one of the following methods to turn off the camera:

- ▶ Go to **Menu > Power** and select **Shutdown**.
- ▶ Press and hold **PWR/REC** until the **Shutting Down...** notification shows on the display.

NOTE: The camera turns off automatically if the supply voltage drops to 11.5 V.

DSMC2 MONSTRO OPERATION GUIDE

AUTO BOOT ON POWER

The DSMC2 Jetpack Expander, DSMC2 Jetpack-SDI Expander, DSMC2 REDVOLT Expander, DSMC2 V-Lock I/O Expander, and DSMC2 Production Module feature a selector switch that enables the camera to automatically boot when power is provided via the DC IN connector on the device. The Auto Boot on Power switch (identified by a line or a white star) is located on top of the device.

When Auto Boot on Power is enabled, the camera disables all power sources that are not the DC IN connector on the expander or module, including batteries and the DC IN connectors on any other modules.

NOTE: The battery plate on the DSMC2 Production Module is always enabled, regardless of the Auto Boot on Power switch position.



Figure: Auto Boot on Power Switch

ENABLE AUTO BOOT ON POWER

1. Toggle the **Auto Boot on Power** switch to **On** (identified by a line or a white star).
2. Connect a power source to the **DC IN** connector.
The camera turns on automatically.
3. Use one of the following methods to turn off the camera:
 - ▶ Go to **Menu > Power** and select **Shutdown**.
 - ▶ Press and hold **PWR/REC** until the **Shutting Down...** notification shows on the display.

NOTE: Simply disconnecting the power source may result in data loss.

DISABLE AUTO BOOT ON POWER

1. Toggle the **Auto Boot on Power** switch to **Off** (identified by a circle or a black star).
The camera will not turn on automatically.

DSMC2 MONSTRO OPERATION GUIDE

CONFIGURE YOUR CAMERA

This section describes common options for configuring your camera system.

DSMC2 SIDEKICK: INSTALL/REMOVE

INSTALL THE DSMC2 SIDEKICK

This section applies to the following items:

- ▶ DSMC2™ SIDEKICK (Forged CF)
- ▶ DSMC2 SIDEKICK (Woven CF)
- ▶ DSMC2 SIDEKICK (Magnesium)

NOTE: Each DSMC2 SIDEKICK is compatible with all DSMC2 cameras.

WARNING: Before installing or removing this item, you **MUST** turn off the camera.

REQUIRED TOOL(S): T10 TORX® driver

1. Turn off the camera.
2. Use a T10 TORX driver to remove the four (4) screws on the BRAIN® side plate (if the side plate is installed).
3. Remove the BRAIN side plate (if the side plate is installed).
4. Place the DSMC2 SIDEKICK in the slot where the lip of the BRAIN side plate was installed.
5. Press the DSMC2 SIDEKICK down flush along the side of camera.
6. Tighten the four (4) captive screws in a cross pattern (“X” pattern) using a T10 TORX driver. **DO NOT FULLY TIGHTEN.**
7. Fully tighten the four (4) screws in a cross pattern (“X” pattern) using a T10 TORX driver.

WARNING: DO NOT OVERTIGHTEN.

REMOVE THE DSMC2 SIDEKICK

This section applies to the following items:

- ▶ DSMC2 SIDEKICK (Forged CF)
- ▶ DSMC2 SIDEKICK (Woven CF)
- ▶ DSMC2 SIDEKICK (Magnesium)

NOTE: Each DSMC2 SIDEKICK is compatible with all DSMC2 cameras.

WARNING: Before installing or removing this item, you **MUST** turn off the camera.

REQUIRED TOOL(S): T10 TORX® driver

1. Turn off the camera.
2. Use a T10 TORX driver to loosen the four (4) captive screws attaching the DSMC2 SIDEKICK to the camera.
3. Remove the DSMC2 SIDEKICK from the camera.

DSMC2 MONSTRO OPERATION GUIDE

INSTALL THE DSMC2 SIDE HANDLE

WARNING: Before installing or removing this item, you MUST turn off the camera.

REQUIRED TOOL(S): T10 TORX driver (if a SIDEKICK Cover or DSMC2 SIDEKICK is installed), M2.5 hex key

1. Turn off the camera.
2. If a SIDEKICK Cover or DSMC2 SIDEKICK is installed, remove the device:
 - A. Use a T10 TORX driver to remove the four (4) screws on the SIDEKICK Cover or DSMC2 SIDEKICK.
 - B. Remove the SIDEKICK Cover or DSMC2 SIDEKICK.
3. Place the DSMC2 Side Handle in the slot where the lip of the SIDEKICK Cover was installed.
4. Press the DSMC2 Side Handle down flush along the side of camera.
5. Tighten the three (3) captive screws and the thumbscrew (in the lower left corner) using an M2.5 hex key. **DO NOT FULLY TIGHTEN.**

NOTE: If you are unable to reach the thumbscrew with a hex key, hand-tighten the thumbscrew.
6. Fully tighten the three (3) screws and the thumbscrew using an M2.5 hex key.

WARNING: DO NOT OVERTIGHTEN.

NOTE: If you are unable to reach the thumbscrew with a hex key, hand-tighten the thumbscrew.

REMOVE THE DSMC2 SIDE HANDLE

WARNING: Before installing or removing this item, you MUST turn off the camera.

REQUIRED TOOL(S): M2.5 hex key

1. Turn off the camera.
2. Use an M2.5 hex key to loosen the three (3) captive screws and the thumbscrew (in the lower left corner).

NOTE: If you are unable to reach the thumbscrew with a hex key, loosen the thumbscrew by hand.
3. Remove the DSMC2 Side Handle from the camera.

INSTALL THE DSMC2 SIDE HANDLE GRIP

NOTE: You may replace the original grip of the DSMC2 Side Handle with a third-party grip. However, RED does not test third-party grips, and cannot confirm if the third-party device will have the same functionality, quality, or strength as the original grip included by RED in the DSMC2 Side Handle. Damage to the DSMC2 Side Handle or other components of the camera system caused by using third-party accessories is not covered under warranty.

REQUIRED TOOL(S): 5 mm hex key

1. Place the original RED grip at the bottom of the DSMC2 Side Handle.
2. Use a 5 mm hex key to install the original M6 x 90 mm screw in the bottom of the grip.

DSMC2 MONSTRO OPERATION GUIDE

DSMC2 EXPANDER: INSTALL/REMOVE

INSTALL A DSMC2 EXPANDER

This section applies to the following items:

- ▶ DSMC2 Base Expander
- ▶ DSMC2 V-Lock I/O Expander
- ▶ DSMC2 REDVOLT Expander
- ▶ DSMC2 Jetpack Expander
- ▶ DSMC2 Jetpack-SDI Expander

WARNING: Before installing or removing this item, you MUST turn off the camera.

WARNING: When installing and removing a DSMC2 REDVOLT Expander, ensure that a REDVOLT battery is NOT installed in the expander. Damage to the REDVOLT or camera system caused by failing to remove the REDVOLT during installation/removal is not covered under warranty.

REQUIRED TOOL(S): T20 TORX driver

1. Turn off the camera.
2. Position the expander on the rear of the camera, aligning the connector on the front of the expander with the connector on the rear of the camera.
3. Apply pressure and tighten the four (4) captive screws in a cross pattern (“X” pattern) approximately two (2) turns each using a T20 TORX driver. DO NOT FULLY TIGHTEN.
4. Fully tighten the four (4) screws in a cross pattern (“X” pattern) using a T20 TORX driver.

WARNING: DO NOT OVERTIGHTEN.

REMOVE A DSMC2 EXPANDER

This section applies to the following items:

- ▶ DSMC2 Base Expander
- ▶ DSMC2 V-Lock I/O Expander
- ▶ DSMC2 REDVOLT Expander
- ▶ DSMC2 Jetpack Expander
- ▶ DSMC2 Jetpack-SDI Expander

WARNING: Before installing or removing this item, you MUST turn off the camera.

WARNING: When installing and removing a DSMC2 REDVOLT Expander, ensure that a REDVOLT battery is NOT installed in the expander. Damage to the REDVOLT or camera system caused by failing to remove the REDVOLT during installation/removal is not covered under warranty.

REQUIRED TOOL(S): T20 TORX driver

1. Turn off the camera.
2. Loosen the four (4) captive screws in a cross pattern (“X” pattern) using a T20 TORX driver.
3. Remove the expander from the camera.

DSMC2 MONSTRO OPERATION GUIDE

DSMC2 POWER MODULES: INSTALL/REMOVE

DSMC2 power module options include:

- ▶ DSMC2 REDVOLT XL Module
- ▶ DSMC2 V-Lock Battery Module
- ▶ DSMC2 Gold Mount Battery Module
- ▶ DSMC2 Production Module

INSTALL THE DSMC2 POWER MODULE

The DSMC2 power modules mount to the rear of the following items:

- ▶ BRAIN
- ▶ DSMC2 Base Expander
- ▶ DSMC2 REDVOLT Expander

WARNING: Before installing or removing this item, you MUST turn off the camera.

REQUIRED TOOL(S): T20 TORX driver

1. Turn off the camera.
2. Position the module on the rear of the camera or expander, aligning the connector on the front of the module with the connector on the rear of the camera or expander.
3. Apply pressure and tighten the four (4) captive screws in a cross pattern (“X” pattern) approximately two (2) turns each using a T20 TORX driver. DO NOT FULLY TIGHTEN.
4. Fully tighten the four (4) screws in a cross pattern (“X” pattern) using a T20 TORX driver.

WARNING: DO NOT OVERTIGHTEN.

REMOVE THE DSMC2 POWER MODULE

WARNING: Before installing or removing this item, you MUST turn off the camera.

REQUIRED TOOL(S): T20 TORX driver

1. Turn off the camera.
2. Loosen the four (4) captive screws in a cross pattern (“X” pattern) using a T20 TORX driver.
3. Remove the module from the camera or expander.

DSMC2 MONSTRO OPERATION GUIDE

DSMC2 TOP HANDLE AND DSMC2 OUTRIGGER HANDLE: INSTALL/REMOVE

INSTALL THE DSMC2 TOP HANDLE OR DSMC2 OUTRIGGER HANDLE

WARNING: Before installing or removing this item, you **MUST** turn off the camera.

REQUIRED TOOL(S): 3/16" hex key

1. Turn off the camera.
2. Position the DSMC2 Top Handle or DSMC2 Outrigger Handle on top of the camera, aligning the connector on the bottom of the handle with the connector on top of the camera.
3. Tighten the two (2) captive screws approximately two (2) turns each using a 3/16" hex key. **DO NOT FULLY TIGHTEN.**
4. Fully tighten the two (2) screws using a 3/16" hex key.

WARNING: DO NOT OVERTIGHTEN.

REMOVE THE DSMC2 TOP HANDLE OR DSMC2 OUTRIGGER HANDLE

WARNING: Before installing or removing this item, you **MUST** turn off the camera.

REQUIRED TOOL(S): 3/16" hex key

1. Turn off the camera.
2. Loosen the two (2) captive screws using a 3/16" hex key.
3. Remove the DSMC2 Top Handle or DSMC2 Outrigger Handle from the camera.

DSMC2 MONSTRO OPERATION GUIDE

INSTALL THE FOCUS HOOK SCREW

The camera comes with a screw stored in the bottom of the media bay, called the focus hook screw. You can install this screw in the Focus Hook Mounting point (along the sensor plane), and then pull focus from that location. You can either attach measuring tape directly to the screw, or you can install a hook to the screw, and attach the measuring tape to the hook.

To install the focus hook screw, follow the instructions below:

REQUIRED TOOL(S): Slotted screwdriver

NOTE: Cameras manufactured before December 2017 include a set screw installed in the Focus Hook Mounting Point. If your camera has this screw, remove the screw with a 1.5 mm hex key before installing the focus hook screw.

1. Remove the focus hook screw from the Focus Hook Screw Storage Location on the media bay using a slotted screwdriver.
2. Tighten the focus hook screw into the Focus Hook Mounting Point on the media bay using a slotted screwdriver.

WARNING: DO NOT OVERTIGHTEN.



Figure: Focus Hook Mounting Point

DSMC2 MONSTRO OPERATION GUIDE

INTERCHANGEABLE OLPF SYSTEM

WARNING: Read these instructions carefully and in their entirety before removing or installing an OLPF. Damage to the OLPF module, camera, or sensor due to improper handling or use is not covered under warranty.

WARNING: Once an interchangeable OLPF is removed from the camera, the sensor is exposed. Improper handling of the OLPF modules or camera during this procedure may compromise the installation or cause irreparable damage to your camera or sensor.

WARNING: DO NOT allow any dirt or debris to enter the optical cavity.

WARNING: Use only VV OLPFs. DO NOT use other OLPFs.

SWAP AN INTERCHANGEABLE OLPF

REQUIRED TOOL(S): T20 TORX driver

1. Turn off the camera.
2. Remove any cables or accessories that may interfere with operations.
3. Loosen and remove the four (4) M4x0.7 x 8 mm lens mount screws in a cross pattern (“X” pattern) using a T20 TORX driver.

NOTE: Some lens mounts have captive screws that are not removable.

NOTE: Screw removal may require a large handle T20 TORX driver and additional leverage.

4. Remove the lens mount.
5. Use a damp, lint-free cloth to gently wipe down the area around the lens mount and OLPF module. Remove as much dust and debris as possible.
6. Use a T20 TORX driver to turn the OLPF lock on the camera counter-clockwise by a third turn to the Unlock position. DO NOT turn the indicator mark past the Unlock icon.
WARNING: DO NOT OVERTIGHTEN.
7. Remove the OLPF module and place it in its protective case.
8. Use an LED light to ensure that the optical cavity is clean and free from dust or debris.
9. Ensure the new OLPF module is clean and free of debris.
10. Install the new OLPF module straight into the optical cavity, keeping the front face of the OLPF module parallel to the front of the camera.
NOTE: Inserting the OLPF module at an angle may cause it to not seat properly.
11. Use a T20 TORX driver to turn the OLPF lock on the camera clockwise by a third turn to the Lock position. DO NOT turn the indicator mark past the Lock icon.
WARNING: DO NOT OVERTIGHTEN.
NOTE: If the lock does not turn easily, gently press down on the OLPF module while turning the lock.
12. Replace the lens mount.
13. Replace and loosely tighten the four (4) M4x0.7 x 8 mm lens mount screws in a cross pattern (“X” pattern) using a T20 TORX driver. DO NOT FULLY TIGHTEN.
NOTE: Some lens mounts have captive screws that are not removable.
14. Fully tighten the four (4) lens mount screws in a cross pattern (“X” pattern) using a T20 TORX driver. DO NOT exceed 350 in-oz, or damage may occur.
WARNING: DO NOT OVERTIGHTEN.

DSMC2 MONSTRO OPERATION GUIDE

USE A TRIPOD OR MONOPOD

This section describes the camera mounting points and mounting equipment for use with a tripod or monopod. The camera is equipped with two (2) 3/8-16 mounting holes and one (1) 1/4-20 mounting hole on the bottom of the camera. These mounting points are designed for use with a variety of mounting plates and hardware, to support tripods and other support systems.

WARNING: Ensure that the tripod, monopod, or support system is designed and rated to handle the weight of your camera configuration. RED is not responsible for any damage caused by using a tripod, monopod, mount, or support system that does not provide sufficient support.

WARNING: DO NOT use excessive force to mount a support accessory, as this may damage the screw threading.

RED offers the following products for use with tripods and other support systems:

Item	Part Number
Mounting Plate (DSMC)	790-0094
DSMC Quick Release Platform Pack	790-0183
Quick Release Platform Pack (Bolt-On)	790-0078
Quick Release Platform (Dovetail)	790-0079
Quick Release Platform (Mini)	790-0390
Dovetail Mounting Plate (Long)	790-0083
Dovetail Mounting Plate (Short)	790-0084

For more information, visit the [RED store](http://www.red.com/store) at www.red.com/store.

DSMC2 MONSTRO OPERATION GUIDE

VIDEO MONITOR OUTPUTS

NOTE: HD-SDI and HDMI® ports are only available on select DSMC2 expanders and modules. For more information, go to ["Input/Output Connectors" on page 218](#).

The monitoring path converts RAW sensor data to a white balanced 12-bit depth 1920 x 1080 pixel RGB 4:4:4 video signal. The signal may be modified using ISO, White Balance, or other RGB color space adjustments. The signal is then scaled and gamma-corrected to provide monitor outputs at 10-bit depth in 4:2:2 YCC or 8-bit depth in 4:4:4 RGB.

The camera offers the following monitor outputs:

- ▶ **EVF/LCD:** Supports a RED EVF or LCD display.
- ▶ **HD-SDI:** Provides a 720p or 1080p output suitable for monitoring or recording to an external VTR or DDR device. It may be configured for 10-bit LIN (VIDEO) or 10-bit LOG (FILM) encoded data.
- ▶ **HDMI:** Provides a 480p, 720p, or 1080p output suitable for monitoring via a Windows® monitor or most HDTVs.

VIDEO MONITOR CATEGORIES

Video monitor outputs are separated into three (3) categories:

- ▶ **VIEWFINDER:** The Upper Status Row, Live Action Area, and Lower Status Row display. Default output is the EVF/LCD connector located on top of the camera. If an EVF or LCD is not connected, you can transfer the VIEWFINDER output to either the HDMI or 3G-SDI (HD-SDI) output.
- ▶ **PROGRAM/Clean:** None of the graphic overlays display.
- ▶ **PREVIEW:** The Live Action Area and associated graphic overlays display.

For more information about changing the video monitor category of your monitor, go to ["Monitor Mode" on page 88](#).

DSMC2 MONSTRO OPERATION GUIDE

RECORD

Perform one of the following actions to begin recording:

- ▶ Press **PWR/REC** on the camera.
- ▶ Press **REC** on the media bay.
- ▶ Press **START/STOP** on the DSMC2 Top Handle or DSMC2 Outrigger Handle.
- ▶ Trigger start/stop with a compatible third-party trigger.
- ▶ Double-tap the right 25% on an attached touchscreen display (when enabled).

NOTE: To enable Double-Tap Right 25% to Record, go ["Advanced" on page 91](#).

RECORD VIA HD-SDI OR HDMI

NOTE: Audio is not embedded in the MON-1 signal.

This section describes how to record via HD-SDI or HDMI through simultaneous record (recording to an SSD and an external recorder at the same time) or external record only.

SIMULTANEOUS RECORD

NOTE: HD-SDI and HDMI ports are only available on select DSMC2 expanders and modules. For more information, go to ["Input/Output Connectors" on page 218](#).

NOTE: The secondary LCD/EVF port and an HDMI/MON-1 port cannot be used at the same time. Go to ["Monitor Preferences" on page 87](#).

You can record simultaneously to an external recorder and a RED SSD. To record simultaneously, follow the instructions below:

1. Attach a DSMC2 expander or module that has an HD-SDI or HDMI port.
2. Connect the camera to an external recorder with an HD-SDI or HDMI cable.
3. Ensure that a formatted SSD is inserted in the camera.
4. Set up the HD-SDI or HDMI output:
 - A. Go to **Menu > Monitoring > Monitors** and select a monitor.
 - B. Select **Clean** from the **Mode** drop-down menu (otherwise the external recorder records the overlay).
 - C. Select the output resolution from the **Resolution** drop-down menu.

NOTE: The HDMI and HD-SDI maximum resolution is 1080p. For more information, go to ["Record/Monitor Out Ports" on page 226](#).
5. Disable all False Colors (otherwise the external recorder records the False Colors). For more information, go to ["Tools" on page 93](#).
6. If monitoring audio via a third-party monitor that supports audio, set up the monitor mix:
 - A. Go to **Menu > Settings > Audio > Mix > Monitor Mix**.
 - B. Adjust the input channels.
7. Go to **Menu > Settings > Recording > Mode**.
8. Select **Local** from the **Storage** drop-down menu.
9. Begin recording.

DSMC2 MONSTRO OPERATION GUIDE

EXTERNAL RECORD

NOTE: HD-SDI and HDMI ports are only available on select DSMC2 expanders and modules. For more information, go to ["Input/Output Connectors" on page 218](#).

NOTE: The secondary LCD/EVF port and an HDMI/MON-1 port cannot be used at the same time. Go to ["Monitor Preferences" on page 87](#).

You can record to an external recorder without recording to an SSD. To record to an external device only, follow the instructions below:

1. Attach a DSMC2 expander or module that has an HD-SDI or HDMI port.
2. Connect the camera to an external recorder with an HD-SDI or HDMI cable.
3. Ensure the SSD is ejected.
4. Set up the HD-SDI or HDMI output:
 - A. Go to **Menu > Monitoring > Monitors** and select a monitor.
 - B. Select **Clean** from the **Mode** drop-down menu (otherwise the external recorder records the overlay).
 - C. Select the output resolution from the **Resolution** drop-down menu.

NOTE: The HDMI and HD-SDI maximum resolution is 1080p. For more information, go to ["Record/Monitor Out Ports" on page 226](#).
5. Disable all False Colors (otherwise the external recorder records the False Colors). For more information, go to ["Tools" on page 93](#).
6. If monitoring audio via a third-party monitor that supports audio, set up the monitor mix:
 - A. Go to **Menu > Settings > Audio > Mix > Monitor Mix**.
 - B. Adjust the input channels.
7. Go to **Menu > Settings > Recording > Mode**.
8. Select **External** from the **Storage** drop-down menu.
9. Begin recording.

CHAPTER 4: BASIC MENUS AND CONTROLS

GUI MENU INTRODUCTION

This section describes the structure and layout of the graphical user interface (GUI) that overlays the video monitor signal. Advanced GUI menu controls enable convenient access to menus, overlays, and other critical camera information. Functionality varies based on monitor output type and firmware version. The GUI menu is separated into three (3) main sections:



Figure: GUI Control Menu

#	ITEM	DESCRIPTION
1	Upper Status Row (Basic Menu)	Easy access to primary camera capture parameters. Go to "Upper Status Row (Basic Menu)" on the next page.
2	Live Action Area	Live camera recording view, overlays, guides, and more. Go to "Live Action Area" on page 62.
3	Lower Status Row	Critical camera parameters, record/playback modes, media and power status, and audio meter. Go to "Lower Status Row" on page 63.

DSMC2 MONSTRO OPERATION GUIDE

UPPER STATUS ROW (BASIC MENU)

The Upper Status Row displays basic project parameters. The currently selected parameter in the Upper Status Row is underlined with a red bar. The Upper Status Row is also known as the Basic Menu.

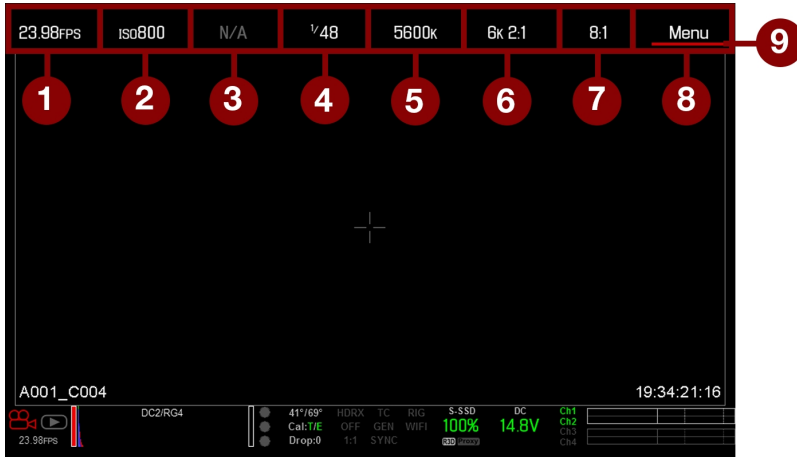

Figure: Upper Status Row

The Upper Status Row includes the following GUI elements:

#	ITEM	DESCRIPTION	DETAILS
1	Frame Rate (fps)	Recording frame rate	"Frame Rate" on page 114
2	ISO	Camera sensitivity	"ISO" on page 84
3	Aperture	Lens aperture (F stop) information	"Aperture" on the next page
4	Exposure (Shutter)	Integration time or shutter angle	"Exposure/Shutter" on page 115
5	Color Temperature	White balance and Tint	"White Balance" on page 82
6	Resolution	Record resolution	"Format" on page 117
7	REDCODE®	REDCODE compression setting	"REDCODE" on page 61
8	Menu	Access advanced settings	"Advanced Menus" on page 79
9	Cursor	Indicates currently selected Upper Status Row element	N/A

ACCESS ADVANCED MENUS

For every Upper Status Row item, you can select the **Advanced...** button to access the related menu in the Advanced Menus.

For example, select **Advanced...** in the Frame Rate menu to open **Menu > Settings > Project > Frame Rate**.

For more information about Advanced Menus, go "[Advanced Menus](#)" on page 79.

DSMC2 MONSTRO OPERATION GUIDE

FEATURE: EDIT LIST

Select the **Edit List...** button in the Upper Status Row menus to change the values that display for each setting. For example, if you open the Frame Rate menu and select **Edit List...**, the camera lets you add or remove values.



Figure: Select "Edit List..." Button

APERTURE

The aperture (also known as the T stop or F stop) parameter displays when a compatible mount and lens are installed. The aperture controls the depth of field of the image and, in combination with the shutter speed/angle setting, controls the amount of light that reaches the sensor (exposure).

- ▶ Increasing the aperture to a higher number increases the depth of field, but reduces the exposure (brightness).
- ▶ Decreasing the aperture to a lower number decreases the depth of field, but increases the exposure (brightness).

RED DSMC PL MOUNT INSTALLED

The current aperture of the attached lens displays when a DSMC[®] PL mount is installed and a supported lens equipped with Cooke[®] S4/i[®] system is attached.

DSMC NIKON MOUNT AND CANON MOUNT INSTALLED

The Aperture menu is visible when a DSMC Nikon[®] Mount, DSMC Canon[®] Mount, or DSMC RED[®] MOTION MOUNT S35 Ti Canon (Captive) is installed and a supported lens is attached. This enables you to adjust the aperture of the attached lens.

Select the **Advanced...** button to access the **Menu > Settings > Setup > Lens** screen. For more information, go to ["Lens" on page 152](#).

DSMC2 MONSTRO OPERATION GUIDE

REDCODE

Select the target REDCODE compression ratio for your project.

If the camera is able to achieve the target compression ratio, the compression ratio displays in white. If the camera is unable to achieve the target compression ratio, the compression ratio displays in yellow, and the camera uses the next possible compression ratio.

The current compression ratio is automatically recalculated when changes are made to the project resolution, aspect ratio, anamorphic setting, frame rate, HDRX[®] mode, media, or the target REDCODE compression ratio.

The REDCODE compression affects the overall quality of the footage. A lower compression (for example: 2:1) increases the quality of the footage, while a higher compression (for example: 22:1) lowers the quality.

REDCODE range is 2:1 to 22:1. Default is 8:1.

For maximum available REDCODE values, see the [DSMC Media Operation Guide](http://www.red.com/downloads) at www.red.com/downloads.

DSMC2 MONSTRO OPERATION GUIDE

LIVE ACTION AREA

The Live Action Area contains the recorded image area, Look Around area, and various overlays. The color of each overlay can be customized to maximize the contrast between the guide(s) and scene being captured.

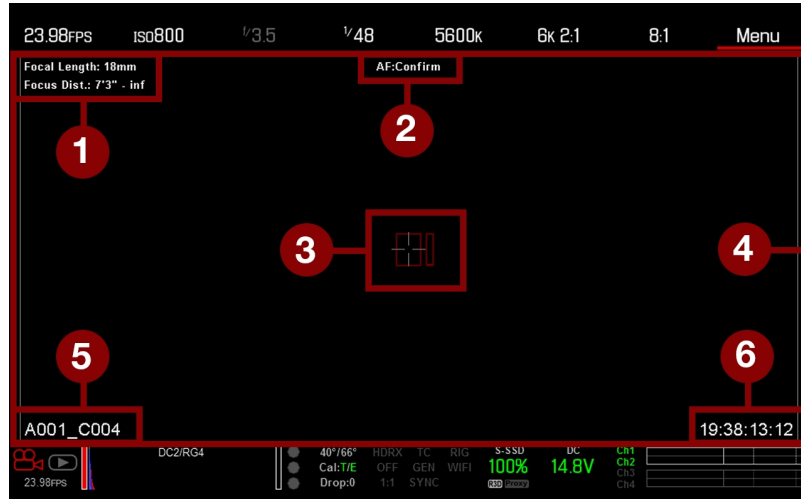

Figure: Live Action Area

The Live Action Area includes the following GUI elements:

#	ITEM	DESCRIPTION	DETAILS
1	Lens Information	Lens information when using supported Canon®, Nikon®, or Cooke® lenses	"Lens Information" on the next page
2	AF Status	Currently selected auto focus mode	"Focus Menu" on page 137
3	Center Crosshair and Spot Focus Guide	Crosshair: Center of selected guide Reference guides: Safe Action/Safe Title, Picture Center, Grid Overlay	"Guides" on page 99
4	Frame Guides	Record or sensor projection area	"Guides" on page 99
5	Clip Filename	Filename of the clip being recorded, or filename of the next clip to be recorded	N/A
6	Timecode Value	Current timecode value	"Timecode" on page 172

DSMC2 MONSTRO OPERATION GUIDE

LENS INFORMATION

This section describes the lens information displays when a supported lens is attached.

PL LENSES

Displays the focal length and focal distance when a DSMC PL mount is installed and a lens with the Cooke S4/i system (or equivalent) is attached. For more information, go to ["Lens" on page 152](#).

CANON AND NIKON LENSES

The camera displays the focal length and focal distance when a DSMC Canon Mount or a DSMC Nikon Mount is installed and an electronically supported lens is attached. When AF is set to Manual or Confirm mode, the focal distance displays as a pair of Near-Far distances. When in AF mode, an estimated focus distance displays. The focal length and focal distance values and range vary depending on the attached lens. When the focal length of the lens changes, the current values displays. For more information, go to ["Lens" on page 152](#).

LOWER STATUS ROW

The Lower Status Row provides access to key system information and camera values.

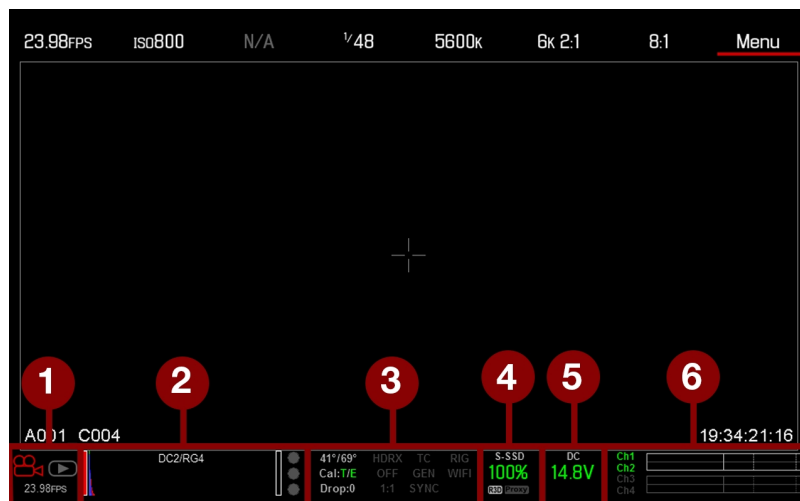

Figure: Lower Status Row

#	ITEM	SUB-ITEM/DESCRIPTION	DETAILS
1	Camera Mode	Swipe up to toggle Motion/Stills/Playback modes	"Camera Mode" on page 65
2	Histogram	Histogram; tap to open the Tools menu	"Histogram" on page 67

DSMC2 MONSTRO OPERATION GUIDE

#	ITEM	SUB-ITEM/DESCRIPTION	DETAILS
3	Project Status Indicators	Tap to open the Project Status menu	"Project Status" on page 156
		Camera sensor and core temperature	"Sensor Calibration" on page 159
		Cal: T/E	"CAL: T/E Indicator" on page 68
		HDRX®: Displays when HDRX mode is on	"HDRX Menu" on page 136
		False Color Mode: Displays modes	"False Color Modes" on page 93
		Magnify mode	"Display Modes: Magnify" on page 95
		Timecode	"TC Indicator" on page 68
		Genlock	"GEN Indicator" on page 68
		Sync	"SYNC Indicator" on page 68
		RM	"RM (Remote) Indicator" on page 68
		LAN	"LAN Indicator" on page 69
4	Media Status	RIG: Indicates 3D rig metadata is present	N/A
		WIFI: Indicates wireless connection	"WiFi Indicator" on page 69
4	Media Status	Media location and remaining capacity; file type (R3D and/or third-party proxy); tap to open the Media Menu	"Media Menu" on page 110
5	Power Status	DC voltage or remaining battery capacity; tap to open the Power menu	"Power Status" on page 69
6	Audio Meter	Audio input and volume; tap to open the Audio menu	"Audio Meter (VU Meter)" on page 168

DSMC2 MONSTRO OPERATION GUIDE

CAMERA MODE

The Camera Mode allows you to seamlessly toggle between Motion mode, Stills mode, and Playback. To select a camera mode, select the **Camera Mode** icon in the Lower Status Bar, swipe up, and select a camera mode.

NOTE: Setting adjustments made in Stills mode do not affect the settings in Motion mode, and vice versa.

You can select the following camera modes:

- ▶ "Motion Mode" below
- ▶ "Stills Mode" on the next page
- ▶ "Playback " on page 105

MOTION MODE

Motion mode optimizes your camera settings for capturing motion. This mode defaults the camera to Continuous Record. Motion mode includes the following features:

- ▶ Motion recording modes:
 - ▶ "Continuous Record" on page 124
 - ▶ "Internal Timelapse Timer" on page 124
 - ▶ "Frame Trigger" on page 125
 - ▶ "Speed Ramp Mode" on page 125
 - ▶ "REDCODE Burst" on page 126
- ▶ Swipe-Up Shortcuts
 - ▶ Camera Mode
 - ▶ False Color
 - ▶ Status
 - ▶ Media
 - ▶ Power
 - ▶ Audio
- ▶ Default Motion Preset (RED)

NOTE: For more information, go to "Swipe-Up Menu" on page 72.

DSMC2 MONSTRO OPERATION GUIDE

STILLS MODE

Stills mode optimizes your camera settings for capturing stills. Stills mode includes the following features:

- ▶ Stills recording modes:
 - ▶ ["Multi-Shot" on page 127](#)
 - ▶ ["Motion + Stills" on page 128](#)
- ▶ Swipe-Up Shortcuts:
 - ▶ False Color
 - ▶ Status
 - ▶ Media
 - ▶ Power
 - ▶ Auto Focus
 - ▶ Auto Exposure
 - ▶ Record Mode
- ▶ Default Stills Preset (RED)

For more information, go to ["Swipe-Up Menu" on page 72](#).

DSMC2 MONSTRO OPERATION GUIDE

HISTOGRAM

NOTE: The sharpness setting affects the Histogram, RAW Level Bars, and RAW Clip Meter. For more information, go to ["Output Sharpness" on page 91](#).

This section describes the elements that comprise the Histogram section in the Lower Status Row. This section of the GUI helps ensure that recorded footage is properly exposed.

Tap the Histogram in the Lower Status Row to access the Tools menu. For more information, go to ["Tools" on page 93](#).

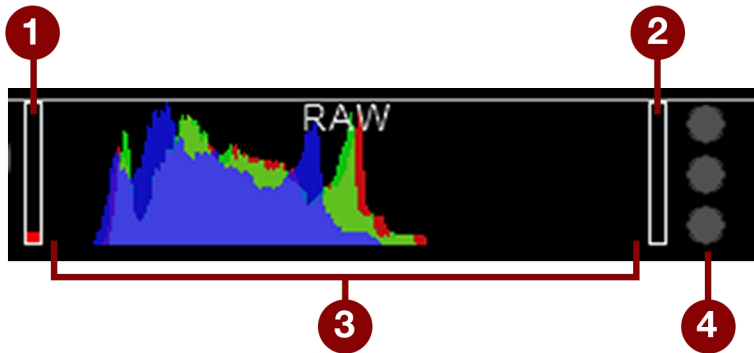

Figure: Histogram (Exposure)

#	ITEM	DESCRIPTION
1	RAW Level Bar (left) ¹	Also known as a “goal post”. Displays the amount of pixels in the image that are underexposed (noise)
2	RAW Level Bar (right) ¹	Also known as a “goal post”. Displays the amount of pixels in the image that are overexposed (clipping)
3	RGB Histogram	Provides a visual representation of exposure and sensor data levels for red, green, and blue channels; meter is affected by White Balance, ISO, and VIEW/LOOK settings
4	RAW Clip Meter	Also known as “traffic lights”. Provides a visual representation of exposure and sensor data levels for red, green, and blue channels; Circles (traffic lights) will light up when clipping occurs

1. The RAW Level Bars represent 1/4 of the total pixels in the image, and illustrate the number of pixels that are noisy or clipped in relation to the total number of pixels. For example, if the left RAW Level Bar is 1/8 of the total height, that means that approximately 1/32 of the total pixels in the total image are at an exposure level that is at risk of displaying noise when pushed to higher ISO or FLUT[®] values in post production.

PROJECT STATUS INDICATORS

This section describes the colors and behavior of the Project Status indicators in the Lower Status Row. Tap the Project Status indicators in the Lower Status Row to access the Project Status menu. For more information, go to ["Project Status" on page 156](#).

DSMC2 MONSTRO OPERATION GUIDE

CAL: T/E INDICATOR

The CAL: T/E indicator shows changes to temperature (T) or exposure (E) in relation to the active calibration map. If the temperature or exposure change significantly, calibrate the sensor at the desired temperature and exposure. Failure to properly calibrate the sensor may reduce image quality.

- ▶ **Green:** Sensor temperature or exposure are properly calibrated for current settings.
- ▶ **Yellow:** Slight change in sensor temperature or exposure.
- ▶ **Red:** Significant change in sensor temperature or exposure.
- ▶ The – and + indicate whether the sensor temperature or exposure has decreased or increased, respectively.

NOTE: T and E indicators change colors independently of each other.

TC INDICATOR

The TC indicator shows the current timecode status.

- ▶ **Grey:** No analog timecode is detected.
- ▶ **Red:** Analog timecode is detected but not enabled.
- ▶ **Green:** Analog timecode is used to jam the time of day timecode.

For more information, go to ["Timecode, Genlock, Multi-Camera Setup" on page 172](#).

GEN INDICATOR

The GEN indicator shows the current genlock status.

- ▶ **Grey:** No genlock signal is detected, or the signal cannot cross-lock to project (24.00 fps vs. 23.98 fps).
- ▶ **Red:** During process of sync, or genlock is lost while recording.
- ▶ **Green:** A genlock signal matching the current HD-SDI monitor rate is locked.
- ▶ **Yellow:** Timing is cross-locked to compatible but not matching monitor rate. For example, genlock is 24.00 fps, and HD-SDI monitor rate is 25.00 fps.

NOTE: When the GEN indicator is yellow, DO NOT perform 3D operation. This warns that genlock source settings and camera settings are not aligned, so phasing of the sync between cameras is not guaranteed.

For more information, go to ["Timecode, Genlock, Multi-Camera Setup" on page 172](#).

SYNC INDICATOR

The SYNC indicator shows the current sensor sync status, based on genlock.

- ▶ **Grey:** The sensor sync mode is not set to genlock.
- ▶ **Red:** The sensor sync mode is set to genlock, but is not locked to a genlock signal. This may occur if genlock or sensor sync is lost while recording.
- ▶ **Green:** The sensor sync mode and HD-SDI monitor rate are locked to a compatible genlock signal.

For more information, go to ["Timecode, Genlock, Multi-Camera Setup" on page 172](#).

RM (REMOTE) INDICATOR

The RM indicator displays if the camera is linked to a third-party remote application, such as foolcontrol.

DSMC2 MONSTRO OPERATION GUIDE

LAN INDICATOR

NOTE: The GIG-E port is only available on the DSMC2® REDVOLT Expander, DSMC2 Jetpack-SDI Expander, and DSMC2 Production Module. For more information, go to ["Input/Output Connectors" on page 218](#).

The LAN indicator shows the current status of an external LAN connection through the Gig-E port.

- ▶ **Grey:** External control of the camera is not enabled.
- ▶ **Green:** Ethernet is enabled.

WIFI INDICATOR

The WiFi indicator shows the wireless connectivity status.

- ▶ **Grey:** Wireless is disabled.
- ▶ **Yellow:** Wireless is not connected.
- ▶ **Green:** Wireless is enabled.

For more information, go to ["Wireless Connection" on page 145](#).

POWER STATUS

The Power Status element displays the current supply voltage or remaining battery capacity. Tap the Power Status element to access the Power menu. For more information, go to ["Power Menu" on page 102](#).

DC IN SUPPLY VOLTAGE

When powering the camera via DC power, the current voltage displays. When powering the camera using batteries, the remaining battery capacity displays. The remaining capacity is indicated by the following colors:

- ▶ **Green:** 12.0 V and up
- ▶ **Yellow:** 11.8 V to 11.9 V
- ▶ **Red:** 11.6 V to 11.7 V

NOTE: The camera turns off automatically if the supply voltage drops to 11.5 V.

BATTERY TIME REMAINING

When using a REDVOLT, REDVOLT-V, or REDVOLT XL battery, the power status displays the location of the power source and the remaining battery capacity.

The color of the displayed battery capacity represents the amount of time remaining:

- ▶ **Green:** >10 minutes
- ▶ **Yellow:** 5 to 10 minutes
- ▶ **Red:** <5 minutes

DSMC2 MONSTRO OPERATION GUIDE

NAVIGATION CONTROLS

This section describes basic controls for navigating the camera menus.

TOUCHSCREEN NAVIGATION

You can control certain settings and navigate the camera menu using buttons and gestures on the RED Touch displays.

RED TOUCH DISPLAY BUTTONS

RED Touch displays offer intuitive menu control and four (4) programmable buttons.



Figure: DSMC2 RED Touch 7.0" LCD

#	RED TOUCH BUTTON	DESCRIPTION
1	User Key 1	Magnify: Toggle
2	Up Button	Increase display brightness
3	Down Button	Decrease display brightness
4	User Key 2	Toggle Exposure Mode on/off

NOTE: RED Touch display keys are programmable. For more information, go to ["Key Mapping" on page 142.](#)

DSMC2 MONSTRO OPERATION GUIDE

RED TOUCH DISPLAY GESTURES

Navigate the menus using a touchscreen by using the following gestures:

- ▶ **Tap:** Tap has many functions:
 - ▶ Tap to select a Basic Menu, submenu, or button.
 - ▶ If a menu is open, tap anywhere outside the menu to save any changes and close the menu.
 - ▶ Tap the right or left regions of the touchscreen to access the programmable soft keys.
- ▶ **Swipe:** Swipe to select different values in spinners or drop-down menus. For more information, go to "[Swipe-Up Menu](#)" on the next page.
- ▶ **Double-Tap:** If the monitor is in Clean mode, changes to Overlay mode.
- ▶ **Hold:** Tap and hold an icon to bring up an advanced interface display.
- ▶ **Pinch:** Move two (2) fingers apart/together to increase/decrease the size of the image. By default, this gesture is disabled.

DSMC2 MONSTRO OPERATION GUIDE

SWIPE-UP MENU

The Swipe-Up Menu is available in the Lower Status Row on RED Touch displays and provides Swipe-Up Shortcuts for Motion mode, Stills mode, and Playback. For example, select the **Camera Mode** icon in the Lower Status Bar, swipe up, and select a **Camera Mode**. For more information about Stills mode and Motion mode, go to "[Camera Mode](#)" on page 65.

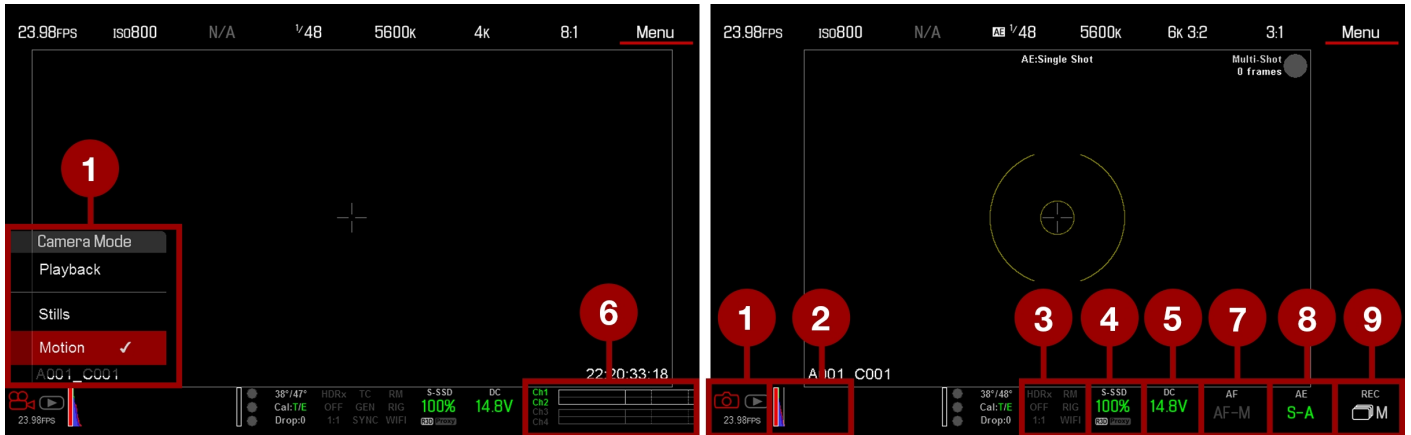

Figure: Swipe Up Menu

#	SWIPE-UP SHORTCUT	DESCRIPTION	MODE
1	Camera Mode	Select Playback, Motion, or Stills	Motion, Stills
2	False Color	Select a false color mode; go to " False Color Modes " on page 93	Motion, Stills
3	Status	View detailed status information	Motion, Stills
4	Media	View as Percentage or Time Remaining, eject media, view clip thumbnails	Motion, Stills
5	Power	View as Percentage, Time Remaining, or Voltage	Motion, Stills
6	Audio	Select Audio settings	Motion
7	Auto Focus	Set Zone, Size, and Mode	Stills
8	Auto Exposure	Set Exp Comp, Speed, Metering, Priority, and Mode	Stills
9	Record Mode	Select Multi-Shot or Motion + Stills	Stills

DSMC2 MONSTRO OPERATION GUIDE

NAVIGATION GROUP

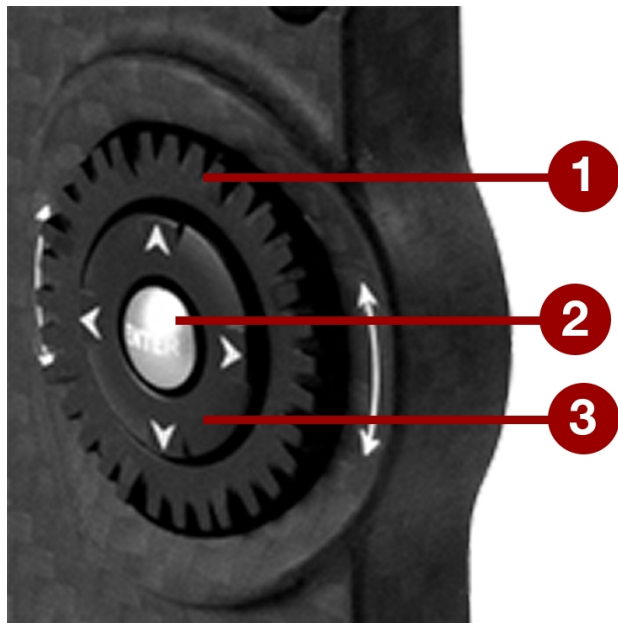

Figure: Navigation Group (DSMC2 SIDEKICK™ Pictured)

The Navigation Group is the primary control interface on the DSMC2 SIDEKICK and DSMC2 Side Handle.

#	NAVIGATION GROUP ELEMENT	DESCRIPTION
1	Scroll Wheel	Select and adjust the value of a selected setting
2	ENTER key	Press ENTER to confirm a setting or access the selected menu
3	Directional Keys	Navigate menus and menu items

Navigate the menus using the following controls:

- ▶ Press **ENTER** to open the menu, then rotate the **Scroll Wheel** clockwise to move right, counterclockwise to move left to highlight the desired menu or parameter. Press **ENTER** to select.
- ▶ Press the **Up Directional Key** to open the related Advanced Settings menu, if one (1) is available.

DSMC2 MONSTRO OPERATION GUIDE

DSMC2 SIDEKICK

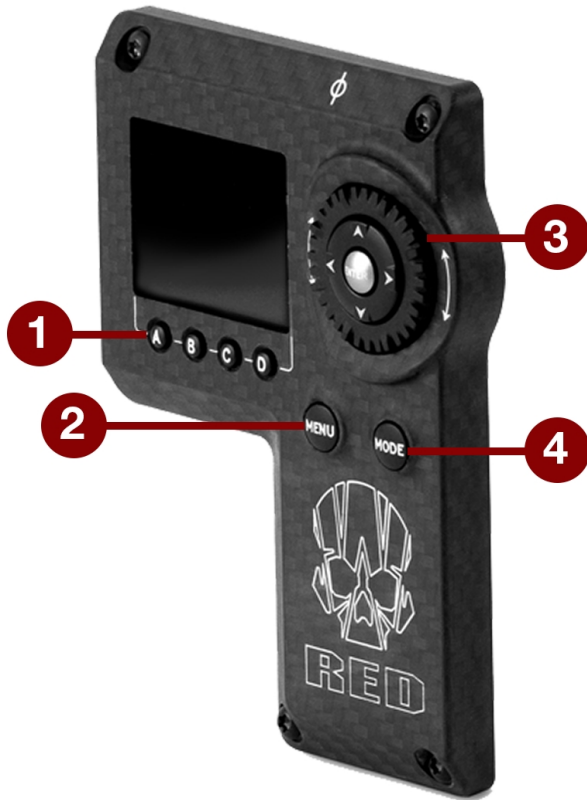

Figure: DSMC2 SIDEKICK

#	CONTROL/ITEM	DESCRIPTION
1	User Keys (A-D) ¹	A: Cycle Auto-Focus Mode B: Auto White Balance C: Toggle: Magnify D: Toggle Exposure Mode
2	MENU Button	Access menus or exit currently selected menu
3	Navigation Group	Navigate menus and menu items; Go to "Navigation Group" on the previous page
4	MODE Button	Toggle between Remote and Local Modes

1. Press User Keys A + D simultaneously to lock/unlock DSMC2 SIDEKICK buttons to prevent inadvertent menu changes.

NOTE: DSMC2 SIDEKICK keys are programmable. For more information, go to ["Key Mapping" on page 142](#).

DSMC2 MONSTRO OPERATION GUIDE

OPERATION MODES

The DSMC2 SIDEKICK display reflects the currently selected mode. Use the **Scroll Wheel** and **Directional Keys** to navigate menus. Press **MENU** to access the Advanced Menu.

Press **MODE** to toggle between the following modes:

- ▶ **Remote Mode:** Navigate with DSMC2 SIDEKICK controls, using an attached LCD, EVF, or other monitor as a reference. The DSMC2 SIDEKICK displays the primary control screen.
- ▶ **Local Mode:** Navigate using the DSMC2 SIDEKICK controls and display. User Keys A-D are inactive.

KEY LOCK/UNLOCK

Lock the keys on the DSMC2 SIDEKICK to prevent inadvertent button presses and menu changes.

- ▶ **Lock:** Press **A + D** simultaneously.
- ▶ **Unlock:** Press **A + D** simultaneously. Alternatively, press and hold **ENTER** while keys are locked.

DSMC2 MONSTRO OPERATION GUIDE

DSMC2 SIDEKICK DISPLAY

The DSMC2 SIDEKICK OLED display provides basic camera parameters during operation.

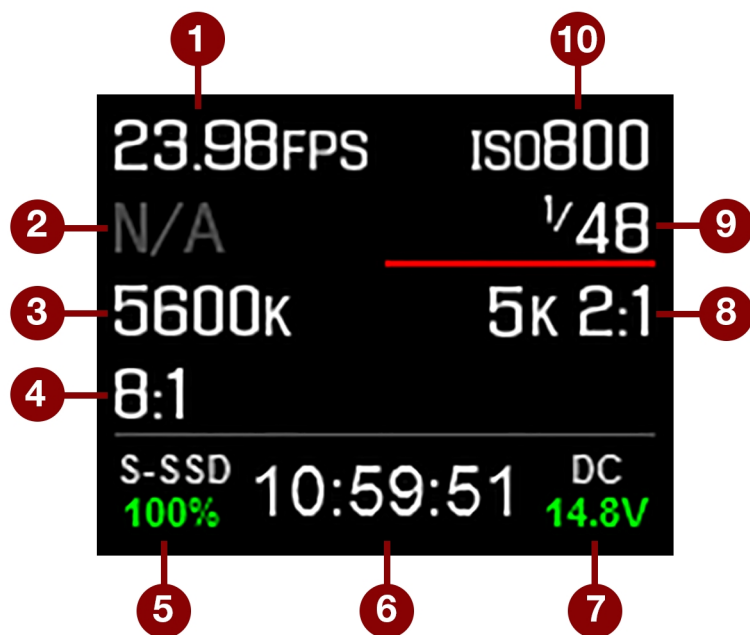

Figure: DSMC2 SIDEKICK OLED (Local Mode)

The DSMC2 SIDEKICK displays the following camera parameters:

#	ITEM	DESCRIPTION
1	Frame Rate	Current Recording Frame Rate
2	Lens Information	Displays aperture if a supported Canon, Nikon, or Cooke lens is attached
3	White Balance	Color temperature
4	REDCODE	REDCODE compression setting
5	Media Status	Displays media location and remaining media capacity
6	Timecode	Current timecode value
7	Power Status	DC supply voltage or % of remaining battery capacity
8	Resolution	Recording resolution
9	Shutter Speed	Integration time or shutter angle
10	ISO	Camera sensor sensitivity

DSMC2 MONSTRO OPERATION GUIDE

DSMC2 SIDE HANDLE



Figure: DSMC2 Side Handle

#	CONTROL/ITEM	DESCRIPTION
1	Focus Control Wheel ¹	Clockwise (Away from camera): Increase focus distance Counter-Clockwise (Toward camera): Decrease focus distance
2	Focus/Record Button	Half-press for auto-focus; full press to Start/Stop Record
3	User Key 1 (Mark Frame Button)	Mark a frame so that you can easily return to it in playback
4	Rotary Side (Iris Control Wheel) ²	Clockwise (Up): Open Iris Counter-Clockwise (Down): Close Iris
5	User Keys (A–D)	A: Cycle Auto-Focus Mode B: Auto White Balance C: Toggle: Magnify D: Toggle Exposure Mode
6	Thumb Pad	Resting area for thumb
7	MENU Button	Access menus or exit currently selected menu
8	Navigation Group	Navigate menus and menu items; Go to "Navigation Group" on page 73
9	Grip	Ergonomic molded rubber grip

1. The Focus Control Wheel is NOT programmable; it cannot be mapped to another function. However, it can be disabled. For more information, go to **"Options" on page 142**.
2. For granular iris control, you can map keys to Iris: Close (Fine Control) and Iris: Open (Fine Control). The Fine Controls open/close the iris in increments of 0.1 F stops.

NOTE: Some DSMC2 Side Handle keys are programmable. For more information, go to **"Default Key Functions" on page 263**.

DSMC2 MONSTRO OPERATION GUIDE

FOCUS CONTROL WHEEL

The Focus Control Wheel allows you to physically control the focus length directly from the DSMC2 Side Handle. The wheel features 270° rotation, and each physical location on the wheel maps directly to a specific focus length of the lens. The far left point (turning counter-clockwise) maps to the shortest focus distance of the lens, while the far right point (turning clockwise) maps to the farthest focus distance of the lens (or infinity).

When a DSMC2 Side Handle is attached, you can continue to adjust focus via the Lens menu **Menu > Settings > Setup > Lens**, if preferred.

To control focus via the Focus Control Wheel, follow the instructions below:

1. Install a DSMC Nikon Mount or DSMC Canon Mount with a supported lens. For more information on supported lenses, go to "[Lenses](#)" on page 251.
2. Set the lens to **Auto**.
3. Turn on the camera (if it is not already turned on). The lens initializes and the camera maps each point on the Focus Control Wheel to a focal length of the lens.
4. Control the focal length by moving the Focus Control Wheel:
 - ▶ **Clockwise (Away from camera)**: Increase focus distance
 - ▶ **Counter-Clockwise (Toward camera)**: Decrease focus distance
5. To re-initialize the lens (remap the Focus Control Wheel to the lens focal lengths), go to **Menu > Settings > Setup > Lens** and select **Lens Init**.

CHAPTER 5: ADVANCED MENUS

ACCESS THE ADVANCED MENUS

To access the Advanced menus, perform one of the following:

- ▶ Tap the **Menu** button on the DSMC2® SIDEKICK™.
- ▶ Tap the **Menu** icon on the touchscreen.
- ▶ Open any menu in the Upper Status Row, and then select the **Advanced...** button.

NOTE: Some menus are only available if certain hardware is present.

IMAGE MENU

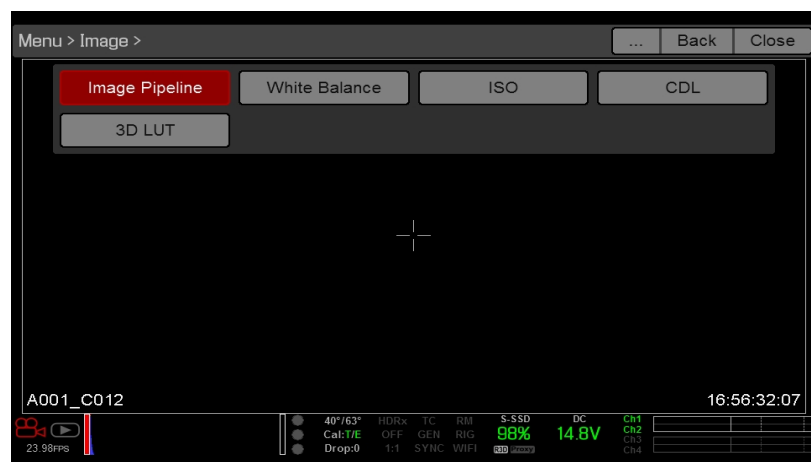

Figure: Image Menu

The Image menu includes tools that control how the image appears, including Color Space and Gamma Curve.

DSMC2 MONSTRO OPERATION GUIDE

IMAGE PIPELINE

To set up the image pipeline, go to **Menu > Image > Image Pipeline**.

IMAGE PIPELINE MODE OPTIONS

The camera offers two (2) different ways to process your image. Each mode changes which sub-menus are available in the Image menu.

- ▶ **Legacy:** In Legacy mode, the camera provides the same color options that firmware v6.3 did. Enables the Color, Gain, Curves, and LGG menus.
- ▶ **IPP2:** Image Processing Pipeline 2 (IPP2) is the new image processing pipeline, which is available starting with firmware v6.4. In IPP2, the camera applies REDWideGamutRGB, which is a color space designed to encompass all colors a RED camera can generate without clipping. The camera then encodes the image using Log3G10, a gamma curve that prevents clipping. Using this color space and gamma curve allows you to grade and make color adjustments in post production, instead of in-camera. Selecting IPP2 enables the CDL menu, and hides the Color, Gain, Curves, and LGG menus (since those are used for grading).

LEGACY MODE

To use Legacy mode, follow the instructions below:

1. Go to **Menu > Image > Image Pipeline > Options**.
2. Select **Legacy** from the **Mode** drop-down menu.
3. Select **OK**.

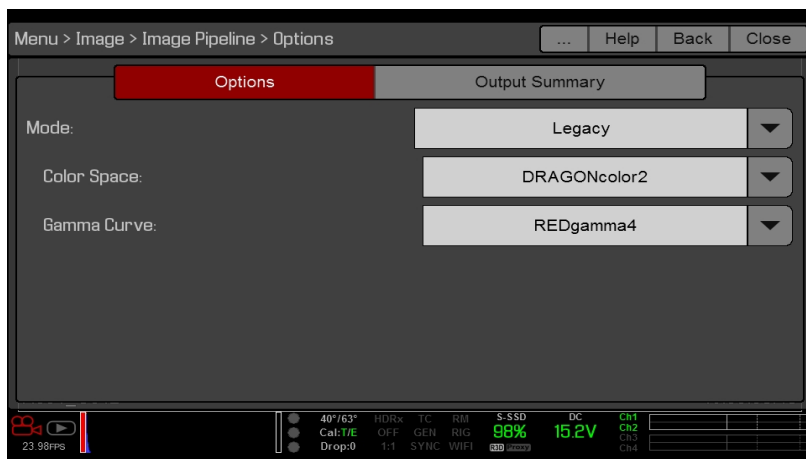

Figure: Legacy Mode

4. Select a color space from the **Color Space** drop-down menu.
5. Select a gamma curve from the **Gamma Curve** drop-down menu.
6. If you want to apply a 3D LUT, go to **"3D LUT"** on page 86.

DSMC2 MONSTRO OPERATION GUIDE

IPP2 MODE

To use IPP2 mode, follow the instructions below:

1. Go to **Menu > Image > Image Pipeline > Options**.
2. Select **IPP2** from the **Mode** drop-down menu. With IPP2, the Color Space and Gamma Curve are always REDWideGamutRGB and Log3G10, respectively.
3. Select **OK**.

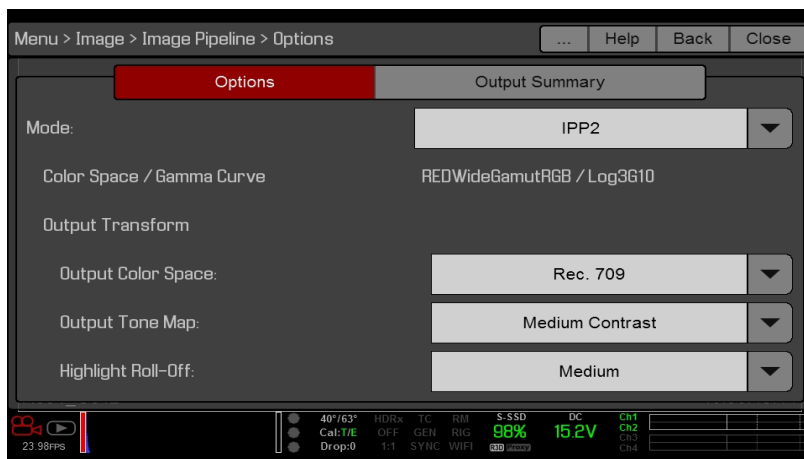

Figure: IPP2 Mode

4. If you want to apply a 3D LUT, go to **"3D LUT"** on page 86.
5. Select a color space from the **Output Color Space** drop-down menu.
6. Select a contrast setting from the **Output Tone Map** drop-down menu.
7. Select a highlight option from the **Highlight Roll-Off** drop-down menu.

DSMC2 MONSTRO OPERATION GUIDE

OUTPUT SUMMARY

The Output Summary menu is an information-only menu that displays what image information is applied to the R3D files and proxy files. To view the output summary, go to **Menu > Image > Image Pipeline > Output Summary**.

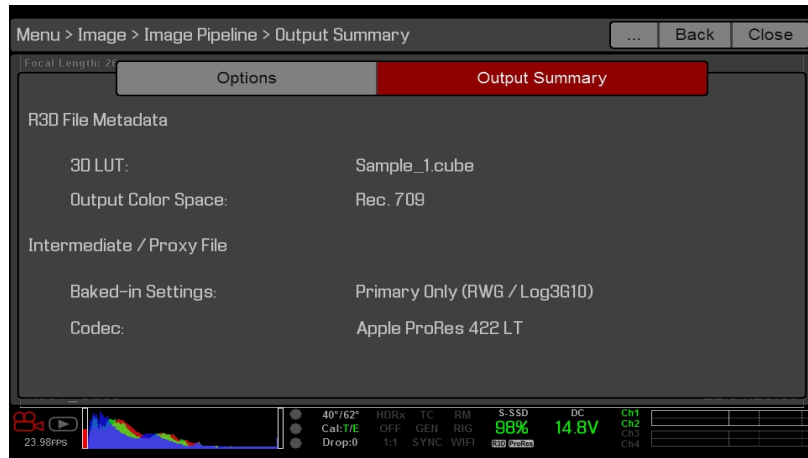

Figure: Image Menu

R3D FILE METADATA

- ▶ **N/A** : Displays if the camera is not set to record R3D files. To enable/disable recording to R3D, go to "**Select Record File Format**" on page 133.
- ▶ **3D LUT**: The name of the 3D LUT applied to the file. If no LUT is applied, the screen displays [NONE].
- ▶ **Output Color Space**: Applicable to IPP2 mode only. The name of the output color space selected on the Options tab.

INTERMEDIATE / PROXY FILE

- ▶ **N/A**: Displays if the camera is not set to record Apple® ProRes files or Avid DNxHD/HR files. To enable/disable recording to these files, go to "**Select Record File Format**" on page 133.
- ▶ **Color Space / Gamma Curve**: Applicable to Legacy mode only. The color space and gamma curve applied to the file.
- ▶ **Baked-in Settings**: Applicable to IPP2 mode only. The image settings that are irreversibly encoded (baked) into the recorded file. To select these settings, go to "**Select Record File Format**" on page 133.
- ▶ **Codec**: The selected codec. To select a codec, go to "**Select Record File Format**" on page 133.

WHITE BALANCE

NOTE: Color temperature is disabled on Monochrome cameras.

Select a color temperature. The range is 1700 to 10,000 KELVIN, and the default is 5600 KELVIN.

TINT

NOTE: Tint is disabled on Monochrome cameras.

Color temperature calculations assume a pure light source that may not be true in the specific scene the camera is imaging. To compensate for any residual colorcast, the Tint parameter adjusts the RGB color balance with a compensating magenta-green color component. Tint range is -100 to 100, with a default of 0.000.

The Tint value displays as a rounded number in the Upper Status Row.

DSMC2 MONSTRO OPERATION GUIDE

NOTE: Selecting Auto White Balance calculates a new Tint value. The value does not change if you adjust the color temperature manually. Selecting a preset resets the Tint to 0.000.

PRESETS

Each preset has 0.000 Tint. Available preset options are:

- ▶ **Incandescent:** 2800 K
- ▶ **Tungsten:** 3200 K
- ▶ **Fluorescent:** 4500 K
- ▶ **Flash:** 5500 K
- ▶ **Daylight:** 5600 K
- ▶ **Cloudy:** 7500 K
- ▶ **Shade:** 9000 K

AUTO WHITE BALANCE

Auto white balance analyzes the central 25% of the image visible in the monitor to calculate a color temperature that will render a white object as white.

To use auto white balance, follow the instructions below:

1. Place a white or grey object under the ambient light.
2. Go to **Menu > Image > White Balance**.
3. Select **Auto White Balance**.

DSMC2 MONSTRO OPERATION GUIDE

ISO MENU

To select an ISO setting, go to **Menu > Image > ISO**.

ISO

NOTE: To see the full range of ISO ratings, select **ISO** in the Upper Status Row, select **Edit List**, and select **Custom**.

NOTE: The default for Monochrome cameras is ISO 2000.

Select the camera ISO rating. The sensitivity value increments in 1/3 stops. When the ISO rating is adjusted, the camera logs the change as metadata and the monitor path reacts accordingly. Higher ISO values lead to brighter images in the monitor path, and vice versa.

RED recommends setting the ISO to the default, then adjusting the aperture, lighting, and ND filters to match. The ISO can later be adjusted around one (1) stop for fine-tuning.

Range is ISO 250 to 12,800. Default is ISO 800.

FLUT

NOTE: This feature is only available in Legacy mode. For more information, go to ["Image Pipeline" on page 80](#).

Floating Point Lookup Table (FLUT) is an exposure control exclusive to RED. FLUT works like a traditional ISO setting, but can be fine-tuned in post production to any level of exposure precision. FLUT automatically protects highlights and shadows, even when changed substantially.

The FLUT setting is expressed in terms of relative exposure value (EV), where each unit represents a 1-stop change in midtone exposure level. Range is -8.0 to 8.0. Default is 0.0.

SHADOW

NOTE: This feature is only available in Legacy mode. For more information, go to ["Image Pipeline" on page 80](#).

Shadow adjusts the toe value of the FLUT (the tone near black). Increasing the Shadow value raises the video level of near blacks. Lowering the Shadow value crushes the video level of near blacks. Range is -2.0 to 2.0. Default is 0.0.

EXPOSURE ADJUST

NOTE: This feature is only available in IPP2 mode. For more information, go to ["Image Pipeline" on page 80](#).

Exposure Adjust (called FLUT in firmware v6.3 and earlier) works like a traditional ISO setting, but can be fine-tuned in post production to any level of exposure precision. Exposure Adjust automatically protects highlights and shadows, even when changed substantially.

The Exposure Adjust setting is expressed in terms of relative exposure value (EV), where each unit represents a 1-stop change in midtone exposure level. Range is -8.0 to 8.0. Default is 0.0.

ISO CALIBRATION

RED cameras with HELIUM®, MONSTRO®, and GEMINI® sensors have an ISO calibration that better matches a light meter and improves overall exposure quality. RED cameras with HELIUM, MONSTRO, and GEMINI sensors therefore depict a one stop brighter image compared to prior sensors (when set to an otherwise identical ISO, T-stop, and shutter speed). ISO 400 now appears as bright as ISO 800 did before, for example.

To match exposure between cameras with HELIUM, MONSTRO, and GEMINI sensors and RED cameras that DO NOT have those sensors, either reduce your camera's ISO speed by 1 stop compared to the other camera, or deselect the **Menu > Image > ISO > Use updated ISO calibration** check box.

As usual, RED recommends using ISO 800 as a starting point for exposure, then adjusting the T-stop and lighting or ND filters to match.

DSMC2 MONSTRO OPERATION GUIDE

CDL

NOTE: This menu is only available in IPP2 mode. For more information, go to ["Image Pipeline" on page 80](#).

American Society of Cinematographers Color Decision List (ASC CDL) controls are a standardized, camera-agnostic way to adjust the look of your images. Color corrections made with a device can therefore be applied or modified by other devices, even if such devices are from different manufacturers and use different standards.

Use the CDL menu to set up:

- ▶ Slope
- ▶ Power
- ▶ Offset
- ▶ Saturation

MANAGE CDLS

Use the CDLs menu to apply and import/export CDLs.

CDLs can be stored on the camera or transferred to SSD to be shared with other cameras. When exporting CDLs from camera to an SSD, the CDLs are saved to a folder on the SSD called "cdls". When importing CDLs from an SSD to camera, the CDLs must be stored on the SSD in a folder called "cdls".

- ▶ **Apply:** Apply the selected CDL.
- ▶ **Create:** Create a new CDL using the current settings.
- ▶ **Delete:** Delete the selected CDL.
- ▶ **➡:** Export selected CDL from camera to SSD.
- ▶ **➡All:** Export all CDLs from camera to SSD.
- ▶ **⬅:** Import selected CDL from SSD to camera.
- ▶ **⬅All:** Import all CDLs from SSD to camera.

COLOR

NOTE: This menu is only available in Legacy mode. For more information, go to ["Image Pipeline" on page 80](#).

NOTE: Saturation is disabled on Monochrome cameras.

- ▶ **Saturation:** Adjusts color saturation. Range is 0.0 (monochrome) to 4.0 (super color). Default is 1.0.
- ▶ **Contrast:** Adjusts the overall contrast of the image. Range is -1.0 (flat) to 1.0 (max contrast). Default is 0.0.
- ▶ **Brightness:** Adjusts brightness without crushing highlights. Available range is -10.0 to 10.0. Default is 0.0.
- ▶ **Exp Comp:** Adjusts exposure compensation. Available range is -7.0 to 7.0. Default is 0.0.

GAIN

NOTE: This menu is only available in Legacy mode. For more information, go to ["Image Pipeline" on page 80](#).

Adjust the red channel, blue channel, and green channel individually. The range for each is 0.0 (none of the color) to 10.0, and the default for each is 1.0.

DSMC2 MONSTRO OPERATION GUIDE

CURVES

NOTE: This menu is only available in Legacy mode. For more information, go to ["Image Pipeline" on page 80](#).

NOTE: Luma is the only channel on Monochrome cameras.

Define the individual curves for the luma, red, green, and blue channels. You can only adjust one (1) curve at a time. Select **Reset Curve** to reset a curve.

LGG (LIFT, GAMMA, GAIN)

NOTE: This menu is only available in Legacy mode. For more information, go to ["Image Pipeline" on page 80](#).

Adjust the lift, gamma, and gain for the red channel, blue channel, and green channel individually.

3D LUT

Use the 3D LUT menu to apply and manage LUTs.

SELECT LUT

If you are recording to a 2K Apple ProRes or 2K Avid DNxHD/HR codec while the camera is in IPP2 mode, you can choose to irreversibly encode (bake) the 3D LUT into the recorded file. For more information, go to ["Select Record File Format" on page 133](#).

When you apply a 3D LUT to a monitor, the name of the 3D LUT displays in the lower left corner of the Live Action area for that monitor. The Display Preset feature controls which Color Space / Gamma Curve pairing and/or 3D LUT is applied to the monitor. For more information, go to ["Display Preset" on page 88](#).

NOTE: The 3D LUT indicator is part of the default "Standard (RED)" overlay, which you can override by selecting or creating a different overlay. For more information, go to ["Custom Overlays" on page 100](#).

To apply a 3D LUT, follow the instructions below:

1. Go to **Menu > Image > 3D LUT**.
2. Select a LUT from the **Creative 3D LUT** drop-down menu.
3. Select **OK**.

EXPORT/IMPORT LUTS

To export and import 3D LUTs, go to **Menu > Image > 3DLUT > Import/Export**.

3D LUTs can be stored on the camera or transferred to SSD to be shared with other cameras. When exporting 3D LUTs from camera to an SSD, the 3D LUTs are saved to a folder on the SSD called "luts". When importing 3D LUTs from an SSD to camera, the 3D LUTs must be stored on the SSD in a folder called "luts".

- ▶ ➡ : Export selected 3D LUT from camera to SSD.
- ▶ ➡All: Export all 3D LUTs from camera to SSD.
- ▶ ⬅ : Import selected 3D LUT from SSD to camera.
- ▶ ⬅All: Import all 3D LUTs from SSD to camera.

DSMC2 MONSTRO OPERATION GUIDE

MONITORING MENU

The Monitoring menu includes tools that control different monitor outputs, Look Around, and overlays.

MONITORS

To set up monitor preferences, go to **Menu > Monitoring > Monitors** and select the monitor whose preferences you want to change. You can set up preferences for each of the following monitors:

- ▶ LCD Top
- ▶ EVF Top
- ▶ LCD Left
- ▶ EVF Left
- ▶ HDMI® (only available when an HDMI port is connected to the system)
- ▶ HD-SDI (only available when an HD-SDI port is connected to the system)
- ▶ MON-1 (only available with the DSMC2 Production Module)
- ▶ SDI-1/2 (only available with the DSMC2 REDVOLT Expander and DSMC2 Production Module)

To see what monitor preferences are available, go to ["Monitor Preferences"](#) below.

MONITOR PREFERENCES

Set up the preferences for the selected monitor. Some options are only available with specific monitors.

NOTE: While some changes take effect immediately, others take effect when you close the menu.

LCD/EVF LEFT / HDMI SELECT

NOTE: This setting is available for the LCD Left, EVF Left, and HDMI.

NOTE: HDMI ports are only available on select DSMC2 expanders. For more information, go to ["Input/Output Connectors"](#) on page 218.

Select to enable either the secondary LCD/EVF port on the camera or the HDMI port on an expander. The secondary LCD/EVF port and the HDMI port cannot be used at the same time.

LCD/EVF LEFT / MON-1 SELECT

NOTE: This setting is available for LCD Left, EVF Left, and MON-1 when a DSMC2 Production Module is attached.

Select to enable either the secondary LCD/EVF port on the camera or the MON-1 port on the DSMC2 Production Module. The secondary LCD/EVF port and the MON-1 port cannot be used at the same time.

DSMC2 MONSTRO OPERATION GUIDE

MONITOR MODE

Select an option for the **Mode** setting, which determines the elements displayed on the monitor:

- ▶ **Clean:** Only the video displays. The Upper Status Row, Lower Status Row, and overlays do not display.
- ▶ **Overlay:** The overlay displays. Overlays include the Upper Status Row and the Lower Status Row.
- ▶ **Mirror:** The monitor mirrors another screen at the same resolution. You cannot mirror a screen that is set to Clean. The Mirror option is available based on the settings of the other attached monitors, and includes the name of the monitor that can be mirrored.

NOTE: You can set a maximum of four (4) monitors to Overlay at a time. To assign additional monitors to Overlay, mirror a monitor with the same resolution that is set to Overlay.

NOTE: When two (2) touchscreens are attached to the camera with the same resolution and one (1) is currently the control surface, set the other to mirror it and give the effect of having two (2) control surfaces.

OVERLAY

Select which overlay shows on top of the video. RED® provides preset overlays, which have "(RED)" in the overlay name. Create custom overlays in the Overlay tab. For more information, go to ["Custom Overlays" on page 100](#).

RESOLUTION

Select the output resolution for monitors (you cannot select a resolution for LCDs and EVFs, since the resolution is determined automatically). For more information about available HD-SDI and HDMI resolutions, go to ["Record/Monitor Out Ports" on page 226](#).

FREQUENCY

Determines the monitor frequency. Available frequencies depend on the selected monitor. The LCD resolution defaults to 60.00 Hz, which is the optimal refresh rate for the RED LCDs.

For HD-SDI monitors, the frequency depends on the project time base. For more information, go to ["Record/Monitor Out Ports" on page 226](#).

HD-SDI Auto: Sets the frequency equal to the Project Time Base, except when the Project Time Base is 47.95/48 fps. When the Project Time Base is 47.95/48 fps, the frequency is half that rate (23.98/24 Hz).

DISPLAY PRESET

Select the Color Space and Gamma Curve combination for the monitor. For more information, go to ["Image Pipeline" on page 80](#).

TOOLS

Enables the false color modes on the monitor. For more information, go to ["False Color Modes" on page 93](#).

FLIP VIDEO

NOTE: This setting is NOT available on the DSMC2 RED Touch 4.7" LCD, DSMC2 RED Touch 7.0" LCD, RED Touch 7.0" LCD, RED Pro Touch 7.0" LCD, and DSMC2 Touch 7.0" Ultra-Brite LCD.

Flip footage horizontally, so that it is upside down. This setting only affects the monitor, and does not affect captured footage.

DSMC2 MONSTRO OPERATION GUIDE

FRAMED OVERLAY

The video display is scaled down on the monitor so that the overlay items fit outside of the video area rather than over it. This setting only affects the monitor, and does not affect captured footage.

AUTO HIDE MENUS

Hides the Upper Status Row and Lower Status Row. When this option is disabled, the video is scaled so that the menus are not overlaid on the video. When this option is enabled, the video is not scaled. This option creates a control surface on a monitor without scaling the video. This setting only affects the monitor, and does not affect captured footage.

To toggle display/hide the menus when Auto Hide Menus is enabled, perform either of the following actions:

- ▶ Press the **Menu** button on the DSMC2 SIDEKICK.
- ▶ Tap the touchscreen.

NOTE: Enabling this option on a non-control surface results in the menus never displaying on that monitor.

FLIP/MIRROR

NOTE: This setting is ONLY available on the DSMC2 RED Touch 4.7" LCD, DSMC2 RED Touch 7.0" LCD, RED Touch 7.0" LCD, RED Pro Touch 7.0" LCD, and DSMC2 Touch 7.0" Ultra-Brite LCD.

Mirror and flip (invert) the graphical user interface (GUI) and footage, effectively rotating the entire displayed image 180°. Use this setting when mounting a monitor or the entire camera rig upside down. This setting only affects the monitor, and does not affect captured footage.

UI FLIP/MIRROR

NOTE: This setting is NOT available on the DSMC2 RED Touch 4.7" LCD, DSMC2 RED Touch 7.0" LCD, RED Touch 7.0" LCD, RED Pro Touch 7.0" LCD, and DSMC2 Touch 7.0" Ultra-Brite LCD.

Flip the GUI vertically and mirror horizontally (not rotated). Use this setting when mounting a monitor upside down. This setting only affects the monitor, and does not affect captured footage.

BRIGHTNESS

Control the brightness of each LCD and EVF. Move to the right for a brighter display; move to the left for a dimmer display.

SIDEKICK LCD BRIGHTNESS

To control the brightness of the DSMC2 SIDEKICK, go to **Menu > Monitoring > Monitors > SIDEKICK**. Move to the right for a brighter display; move to the left for a dimmer display.

DSMC2 MONSTRO OPERATION GUIDE

PRIORITY

The camera can only have one (1) control monitor for interacting with camera settings. The Priority tab determines the order in which a monitor becomes the control monitor. If you plan on removing or adding monitors during a shoot, set up the priority list ahead of time.

For a monitor to become the control monitor, the following must occur:

- ▶ The monitor must be set to Overlay mode in the Monitor Control menu.
- ▶ Each monitor that has higher priority on the list must be either detached or not set to Overlay mode.

EXAMPLE

By default, the monitor priority is:

1. LCD
2. EVF
3. HDMI

If you remove an LCD when an EVF is attached, then the EVF becomes the control monitor. If you then remove the EVF when an HDMI monitor is attached, the HDMI monitor becomes the control monitor. If you then re-attach the LCD, then the LCD is the control monitor again.

TEST SIGNAL

Use the Test Signal menu to replace the video monitor outputs with one of the following video test patterns:

- ▶ Chip Chart
- ▶ SMPTE Bars
- ▶ Luma

NOTE: Test signals are not recordable; they are provided to help align external HD-SDI and HDMI monitors.

AUDIO TONE

To apply an audio tone, follow the instructions below:

1. Go to **Menu > Monitoring > Test Signals**.
2. Toggle **Tone** On/Off.

LOOK AROUND

To enable Look Around, go to **Menu > Monitoring > Look Around**.

When Look Around is enabled, the Frame Guide and recording area are scaled down on the display so that you can see what images will enter the recording area.

To assign a Shading overlay to the Look Around area (the area outside of the recording area), go to **"Guides" on page 99**.

Look Around limits the available frame rates. At high resolutions, the recording area on the display shows the full sensor area or full sensor height, so there is no extra room for Look Around.

Look Around may affect the recorded file:

- ▶ **R3D:** Only the area inside the frame is recorded; the Look Around area is NOT recorded.
- ▶ **Apple ProRes:** The full image is recorded, including the Look Around area.
- ▶ **Avid DNxHD/HR:** The full image is recorded, including the Look Around area.

DSMC2 MONSTRO OPERATION GUIDE

ADVANCED

Provides access to additional monitor settings.

VIDEO

SMALL DIALOGS ON 9" LCD

The dialogs on the RED Touch 9.0" LCD are smaller than the default dialogs.

ALLOW REDUCED JUDDER PREVIEW

Reduced Judder Preview allows the camera to preview images at a refresh rate that is twice the project time base. For example, if the project time base is 23.98 FPS or 24.00 FPS, enabling Reduced Judder Preview causes the LCD or EVF to have a refresh rate of 48 Hz (50 Hz).

You cannot use Reduced Judder Preview when:

- ▶ Varispeed is enabled.
- ▶ Speed Ramp mode is enabled.
- ▶ Genlock is enabled.
- ▶ The shutter angle is 180° or greater.

NOTE: When you disable Reduced Judder Preview mode, the image on the EVF may be disrupted for up to three (3) seconds.

GLOBAL FLIP/MIRROR

Applies Flip/Mirror to all monitors. For more information, go to ["Flip/Mirror" on page 89](#).

OUTPUT SHARPNESS

Control the sharpness of each monitor output. Move to the left for a sharper image; move to the right for a less sharp image.

NOTE: The sharpness setting affects the Histogram, RAW Level Bars, RAW Clip Meter, and false color modes. For more information, go to ["Histogram" on page 67](#) and ["False Color Modes" on page 93](#).

NOTE: The camera applies the sharpness setting to recorded proxy files.

AUTO FOCUS PEAKING

When Auto Focus Peaking mode is enabled (either Focus or Edge), the camera automatically goes onto Focus Peaking mode when you manually adjust the focus via the lens.

- ▶ **Off:** The camera does not automatically go into Focus Peaking mode.
- ▶ **Focus:** The camera automatically goes into Focus Peaking mode when you manually adjust the focus via the lens. Emphasizes contrast and edges in the image without changing brightness or image content making it easier to judge focus.
- ▶ **Edge:** The camera automatically goes into Focus Peaking mode when you manually adjust the focus via the lens. Shows the edges/outlines of objects that are in focus.

DSMC2 MONSTRO OPERATION GUIDE

TOUCH

- ▶ **Lock Touchscreen:** Touchscreen control is locked. To unlock, tap the screen and follow the on-screen instructions.
- ▶ **Pinch to Magnify:** Move two (2) fingers apart or together to toggle Magnify. For more information, go to "[Display Modes: Magnify](#)" on page 95.
- ▶ **Double Tap Right to Record:** Double-tap the right 25% of the video area on the LCD to toggle record.
- ▶ **Double Tap Left to AF:** Double-tap the left 25% of the video area on the LCD to start autofocus when compatible lenses are used.

GENLOCK OFFSET

NOTE: HD-SDI ports are only available on select DSMC2 expanders. For more information, go to "[Input/Output Connectors](#)" on page 218.

Offset the video of the HD-SDI out to align it with the genlock signal:

- ▶ **Negative offset:** Advances the video, so the video reaches the switcher earlier than it would otherwise.
- ▶ **Positive offset:** Delays the video, so the video reaches the switcher later than it would otherwise.

DSMC2 MONSTRO OPERATION GUIDE

OVERLAYS MENU

The Overlays menu includes settings that display on top of the monitor image.

TOOLS

The Tools menu provides access to false color and display modes.

For more information, see the [Exposure with RED Cameras: False Color & Zebra Tools](http://www.red.com/learn/red-101/exposure-false-color-zebra-tools) article, available at www.red.com/learn/red-101/exposure-false-color-zebra-tools.

FALSE COLOR MODES

False color modes include:

- ▶ "False Color Modes: Off" below
- ▶ "False Color Modes: Exposure" on the next page
- ▶ "False Color Modes: Video" on the next page
- ▶ "False Color Modes: Focus" on the next page
- ▶ "False Color Modes: Edge" on the next page
- ▶ "False Color Modes: Peaking" on page 95
- ▶ "False Color Modes: Gio Scope" on page 95

NOTE: Only monitors with the Tools check box selected in the Monitor Control menu show the false colors. For more information, go to "Tools" on page 88.

NOTE: The sharpness setting affects the false color modes. For more information, go to "Output Sharpness" on page 91.

NOTE: False color modes affect video recorded through HDMI® or HD-SDI to an external recorder if the Tools check box is selected in the Monitor Control menu. When recording through HDMI or HD-SDI, use false color modes only to help configure project settings, and then disable the mode before recording.

NOTE: Since the 3D LUT modifies the data displayed for the exposure tools, you cannot use the exposure tools with a 3D LUT.

DISPLAY MODES

Display modes include:

- ▶ "Display Modes: Magnify" on page 95
- ▶ "Display Modes: Log View" on page 96
- ▶ "Display Modes: RAW" on page 96
- ▶ "Display Modes: Horizon" on page 96
- ▶ "Display Modes: Zebras" on page 97

FALSE COLOR MODES: OFF

To disable all false color modes, go to **Menu > Overlays > Tools > False Color** and select **Off** from the **False Color** drop-down menu.

DSMC2 MONSTRO OPERATION GUIDE

FALSE COLOR MODES: EXPOSURE

To enable, go to **Menu > Overlays > Tools > False Color** and select **Exposure** from the **False Color** drop-down menu.

The Exposure tool displays a color overlay on top of a desaturated image that allows you to check for proper exposure. When enabled, the “E√” indicator displays in the Lower Status Row.

The Exposure meter colors indicate the following information:

- ▶ **Purple:** Underexposed; indicates sensor exposure levels that may be noisy if gained up in post production.
- ▶ **Green:** IRE 41–48; based on the RGB levels of the video out signal and not the RAW data.
- ▶ **Red:** Overexposed; indicates sensor exposure levels that are clipping.

Purple (underexposure) and red (overexposure) are based on RAW data and show areas that are clipping or close to clipping. The RGB settings DO NOT affect the Exposure indicators.

FALSE COLOR MODES: VIDEO

To enable, go to **Menu > Overlays > Tools > False Color** and select **Video** from the **False Color** drop-down menu.

The Video tool displays a color overlay that indicates the video level of the RGB monitor path (calibrated to the SMPTE test signal). When enabled, the “V√” indicator displays in the Lower Status Row.

Colors are based on the RGB levels of the video out signal (that is, the “cooked” look, and not RAW data). The RGB settings affect the Video indicators.

The Video indicators represent the following IRE values (at all other values, the desaturated image represents the luminance value of the ISO adjusted image):

- ▶ **Purple:** IRE 0–4
- ▶ **Blue:** IRE 5
- ▶ **Teal:** IRE 10–12
- ▶ **Green:** IRE 41–48
- ▶ **Pink:** IRE 61–70
- ▶ **Straw:** IRE 92–93
- ▶ **Yellow:** IRE 94–95
- ▶ **Orange:** IRE 96–98
- ▶ **Red:** IRE 99–100

FALSE COLOR MODES: FOCUS

To enable, go to **Menu > Overlays > Tools > False Color** and select **Focus** from the **False Color** drop-down menu.

The Focus tool emphasizes contrast and edges in the image without changing brightness or image content making it easier to judge focus. Adjust zoom and focus to easily see which objects are coming into focus.

When enabled, the “F√” indicator displays in the Lower Status Row.

FALSE COLOR MODES: EDGE

To enable, go to **Menu > Overlays > Tools > False Color** and select **Edge** from the **False Color** drop-down menu.

Shows the edges/outlines of objects that are in focus. When enabled, the “F√” indicator displays in the Lower Status Row.

NOTE: The Edge setting may interfere with recordings done via HDMI or HD-SDI in Clean mode.

DSMC2 MONSTRO OPERATION GUIDE

FALSE COLOR MODES: PEAKING

To enable, go to **Menu > Overlays > Tools > False Color** and select **Peaking** from the **False Color** drop-down menu.

The Focus Peaking tool displays a red overlay on top of in-focus edges. Select a Peaking Level of 1 to 10 (weak to strong). The RGB settings affect the indicators.

The Focus Peaking indicators are applied after the image is scaled to a monitor, so the indicators may look different on different monitors.

When enabled, the “P√” indicator displays in the Lower Status Row.

FALSE COLOR MODES: GIO SCOPE

To enable, go to **Menu > Overlays > Tools > False Color** and select **Gio Scope** from the **False Color** drop-down menu.

Displays a color overlay on top of a desaturated image, identifying 16 increments within the dynamic range of the sensor.

When enabled, the “G√” indicator displays in the Lower Status Row. The Gio Scope indicators are based on RAW data. The RGB settings (color temperature, ISO, LGG, etc.) DO NOT affect the indicators.

Each number indicates a different increment of dynamic range.

- ▶ **10:** Represents mid-grey.
- ▶ **16:** Represents the top increment, and is broken up into 1/8th sub-increments to show highlight roll-off. Each 1/8th increment is represented by a different shade of red, ranging from light red (less light) to dark red (most light).

DISPLAY MODES: MAGNIFY

To enable, go to **Menu > Overlays > Tools** and select **Magnify**.

The Magnify tool displays the central region of the sensor in 1:1 pixel resolution on an attached monitor. When enabled, the 1:1 text in the Lower Status Row turns green, and the AF Window and the magnified region display. The AF Window determines the center point of the magnified region. If the lens or lens mount is not capable of autofocus with the camera, use Confirm mode to turn on the AF Window. Sharpening is disabled when Magnify mode is enabled. The camera automatically exits Magnify mode when recording begins.

The Magnify tool magnifies a 1920 x 1020 region, centered on a 1920 x 1080 display. If the resolution is lower than 1920 x 1020, the image border cannot be magnified. Use the following equations to determine the area of the image border that will not be magnified:

- ▶ **Border width:** $(1920 - W) / 2$
- ▶ **Border height:** $(1020 - H) / 2$

NOTE: Frame rate and resolution cannot be modified in Magnify mode.

DSMC2 MONSTRO OPERATION GUIDE

DISPLAY MODES: RAW

NOTE: RAW is only available in Legacy mode. For more information, go to ["Image Pipeline" on page 80](#).

To enable, go to **Menu > Overlays > Tools** and select **RAW**.

When enabled, the camera displays images unaffected by the RGB settings (color temperature, ISO, LGG, etc.). RAW affects the video recorded via HDMI or HD-SDI to an external recorder. RAW image parameters DO NOT affect image metadata; the parameters only affect the monitor output.

The RAW image parameters are:

- ▶ **Color Space:** DRAGONcolor2
- ▶ **Gamma Space:** REDgamma4
- ▶ **White Balance:** 5600K
- ▶ **ISO:** 800 ISO
- ▶ **Tint:** 0 Tint

NOTE: In RAW mode, the following controls are disabled on all cameras: color temperature, tint, saturation, RGB gains, ISO, contrast, brightness, shadow, FLUT[®], exposure compensation, LGG controls, RGB curves, and luma curve.

DISPLAY MODES: LOG VIEW

NOTE: Log View is only available in IPP2 mode. For more information, go to ["Image Pipeline" on page 80](#).

To enable, go to **Menu > Overlays > Tools** and select **Log View**.

When enabled, the camera displays images in REDWideGamutRGB and Log3G10 that are only affected by the ISO, Exposure Adjust, Color Temperature, and Tint settings. This allows you to quickly see ungraded footage that remains unaffected by creative decisions such as the choice of 3D LUT or CDL. Log View affects the video recorded via HDMI or HD-SDI to an external recorder, but does not affect the R3D file itself.

DISPLAY MODES: HORIZON

To enable, go to **Menu > Overlays > Tools** and select **Horizon**.

Displays an overlay that provides a reference to the position of the horizon. The Horizon overlay consists of two (2) short side-bars that are always horizontally centered on the monitor, and a single longer horizon-line that adjusts to the horizon based on the orientation of the camera.

The side-bars are green if the pitch is within $\pm 1^\circ$ of the calibrated zero position, otherwise they are red. The horizon-line is green if the roll is within $\pm 1^\circ$ of the calibrated zero position, otherwise it is red.

To add numerical values for the pitch and roll to the Horizon overlay, follow the instructions below:

1. Go to **Menu > Overlays > Custom**.
2. Select **Create...**, **Clone...**, or **Edit...**, respectively, for the desired overlay action.
3. Select a location on the interface to add the numerical data for the Horizon overlay.
4. Select **Motion: Gyro Data (GYRO)** from the **Item** drop-down menu.
5. Select the desired text size.
6. Select **Add**.
7. Select **Save**.
8. Apply the custom overlay to a monitor. For more information, go to ["Monitor Preferences" on page 87](#).

NOTE: The internal gyroscope and accelerometer must be calibrated for the Horizon overlay to function properly. For more information, go to ["Gyroscope and Accelerometer Calibration" on page 154](#).

DSMC2 MONSTRO OPERATION GUIDE

DISPLAY MODES: ZEBRAS

Use Zebra mode to enable and adjust the upper and lower values for two (2) independent zebra indicators. Use Zebra 1 for highlight exposure, and use Zebra 2 for mid-tones or shadows. Zebras are visible in Magnify mode and are disabled by default.

The camera offers two (2) zebra types:

- ▶ **Video:** IRE-based mode; evaluates based on the current ISO and Look settings, and not the RAW image.
- ▶ **RAW:** Evaluates based on the RAW image.

For more information, see the [Exposure with RED Cameras: False Color & Zebra Tools](http://www.red.com/learn/red-101/exposure-false-color-zebra-tools) article, available at www.red.com/learn/red-101/exposure-false-color-zebra-tools.

ENABLE ZEBRA INDICATORS

1. Go to **Menu > Overlays > Tools** and select **Zebras**.
2. Select a **Zebra**:
 - ▶ **Zebra 1:**
 - ▶ **Video:** Areas of the image exposed within the IRE range are indicated by red diagonal lines at -45° . Default is 98 to 100 IRE.
 - ▶ **RAW:** Areas of the image exposed within the range of stops are highlighted. Default is 15.80 to 16.00 stops.
 - ▶ **Zebra 2:**
 - ▶ **Video:** Areas of the image exposed within the IRE range are indicated by green diagonal lines at 45° . Default is 41 to 48 IRE.
 - ▶ **RAW:** Areas of the image exposed within the range of stops are highlighted. Default is 0.00 to 4.00 stops.
3. If you selected RAW, select how you want the RAW areas to look by setting up the **Raw Style** options (fill and color).

DSMC2 MONSTRO OPERATION GUIDE

CAMERA AND LENS STATUS

To set up what camera and lens info displays as part of the overlay, go to **Menu > Overlays > Status**.

CAMERA STATUS OVERLAYS

EXPOSURE

- ▶ **Shutter Speed:** Displays the exposure time in seconds (1/xx sec). When you change the frame rate in this mode, the shutter speed stays the same, but the shutter angle changes. (Default)
- ▶ **Shutter Angle:** Displays the exposure as an angle (1° to 360°). When you change the frame rate in this mode, the shutter angle stays the same, but the shutter speed changes.

POWER

- ▶ **Current Batt %:** Displays the remaining percentage of active battery. (Default)
- ▶ **Total Time:** Displays the total run-time left of battery power, taking into account all available batteries.
- ▶ **Voltage:** Displays the voltage.

VU METER

- ▶ **Input:** Displays levels of audio inputs (pre-mixer). (Default)
- ▶ **Output:** Displays levels of audio outputs (post-mixer).

HISTOGRAM

NOTE: The Histogram setting is disabled on Monochrome cameras.

- ▶ **RGB:** Displays red, green, and blue channels on histogram. (Default)
- ▶ **Luma:** Displays luma channel on histogram.

MEDIA

- ▶ **Percentage:** Displays media space remaining as a percentage. (Default)
- ▶ **Time Remaining:** Displays media space remaining as time in hours and minutes (HHH:MM).

LENS STATUS OVERLAYS

APERTURE INCREMENTS

- ▶ **1/4 Stop:** Aperture increments in 1/4 stops.
- ▶ **1/3 Stop:** Aperture increments in 1/3 stops. (Default)

FOCUS DISTANCE

- ▶ **Metric:** Displays lens focus distances in meters.
- ▶ **Imperial:** Displays lens focus distances in feet and inches. (Default)

MOTION MOUNT ND AND MOTION MOUNT ISO PULL

Only applicable when using a DSMC RED MOTION MOUNT® S35 lens mount. For more information, see the **RED MOTION MOUNT Operation Guide**, available at www.red.com/downloads.

DSMC2 MONSTRO OPERATION GUIDE

RACK SHOW DISTANCE

- ▶ **On:** Displays the focus distance of each rack point on the Live Action Area when rack focus is enabled. For more information, go to "[Set Up Rack Focus](#)" on page 139.
- ▶ **Off:** Does not display the focus distance of rack points when rack focus is enabled. (Default)

GUIDES

Use the Guides menu to configure the Frame Guide, Action Guide, and Title Guide.

MODE

- ▶ **Off:** Disable all guides.
- ▶ **Full:** Guide has the same aspect ratio as the record format.
- ▶ **4:3, 16:9, 1.85:1, 1.9:1, 2.4:1:** Guide has the selected aspect ratio.
- ▶ **User:** Select an aspect ratio from the drop-down menu that displays when you select this option.
- ▶ **Absolute:** Guide is defined by absolute pixel dimensions rather than aspect ratio and scale. When you select Absolute, the Width/Height fields replace the Scale field.

SCALE

Percentage to scale guide from its maximum possible size. Available range is 0 to 100%.

WIDTH/HEIGHT

The Width/Height fields replace the Scale field when you select Absolute from the Mode drop-down menu. Select the values for the width and height of the guide in pixels.

OFFSET X/Y

Percentage to offset guide from its default centered position. Available range is -100 to 100%.

- ▶ **100%:** Right-aligned (for X offset) and bottom-aligned (for Y offset).
- ▶ **-100%:** Left-aligned (for X offset) and top-aligned (for Y offset).

APPEARANCE

- ▶ **Line Style:** Select one of the following line styles: Solid, Dashed, or Bracket.
- ▶ **Color:** Select the color that has the highest contrast to the scene. The default is White.
- ▶ **Opacity:** Set the guide opacity. Available options are 25%, 50%, 75% and 100%.

RELATIVE TO FRAME GUIDE

Select the **Relative to Frame Guide** check box to size and position the guide relative to (and have it bounded by) the Frame Guide instead of the record format.

NOTE: The Relative to Frame Guide check box is available on the Action Guide and Title Guide tabs.

Enable/Disable and select the location (Relative To), color, and opacity of the following elements:

- ▶ **Center:** The center crosshair. You can select the following shapes: Cross (crosshair), Small Dot, Medium Dot.
- ▶ **Grid:** Rule-of-thirds grid.
- ▶ **Shading:** The shaded region outside of the area of interest.

DSMC2 MONSTRO OPERATION GUIDE

CUSTOM OVERLAYS

Create custom overlays that include specific items. Overlays can be stored on the camera or transferred to SSD to be shared with other cameras.

- ▶ **Camera:** Overlays saved internally on the camera display in the Overlay drop-down menu on the Monitor Control > Monitor tab.
- ▶ **Media:** Overlays saved to an SSD can be found at On Media: \overlays:.

NOTE: Overlays that end with (RED) are provided by default and cannot be edited, deleted, or exported.

OVERLAY ACTIONS

- ▶ **Create...:** Create a new custom overlay using a blank overlay template in the Overlay Editor.
- ▶ **Clone...:** Create a new custom overlay using the selected camera overlay as a template in the Overlay Editor.
- ▶ **Edit...:** Edit the selected camera overlay in the Overlay Editor.
- ▶ **Delete:** Delete the selected camera overlay.

EXPORT AND IMPORT OVERLAYS

- ▶ ➡ : Export selected overlay from camera to SSD.
- ▶ ➡ **All:** Export all overlays from camera to SSD.
- ▶ ⬅ : Import selected overlay from SSD to camera.
- ▶ ⬅ **All:** Import all overlays from SSD to camera.

DSMC2 MONSTRO OPERATION GUIDE

CREATE AND EDIT OVERLAYS

1. Go to **Menu > Overlays > Custom**.
2. Select **Create**, or select an existing overlay and select **Clone** or **Edit**.
3. If creating a new overlay, enter a name for the overlay and select **OK**.
4. Select any of the following check boxes to add the corresponding guides to the overlay:
 - ▶ Frame Guide
 - ▶ Action Guide
 - ▶ Title Guide

5. Select a button on the matrix to add a user interface element to that position on the matrix.

By default, the Magnify indicator (MI) is on the top left, the Record indicator (REC) is on the top right, the Clip Name (CLIP) is on the bottom left, and the Timecode (TC) is on the bottom right.

Selecting one (1) of the buttons opens a new dialog that lets you choose a user interface element.

6. Select the **Item** that you want to add.
7. Select the **Size** of the item.
8. If adding a Custom Label (LBL), enter the **Custom Text** for that item.
9. Select **Add** to return to the previous screen.
10. Add all of the items to the overlay.
11. Select **Create** or **Save**.

The new overlay displays in the Camera list.

NOTE: Except for the Custom Label (LBL), you can only add each element once. If you add an element you have already added to the overlay, the element moves to the new position.

DSMC2 MONSTRO OPERATION GUIDE

POWER MENU

The Power menu displays the power status of all attached power sources and allows you to turn off the camera.

To access the Power Menu, go to **Menu > Power**.

NOTE: For more information about powering the camera, see the [DSMC Power Operation Guide](http://www.red.com/downloads), available at www.red.com/downloads.

POWER IN

The power status displays for all attached power devices. The menu displays the voltage of the source or the relative percentage of the power left, as well as the time left, if applicable.

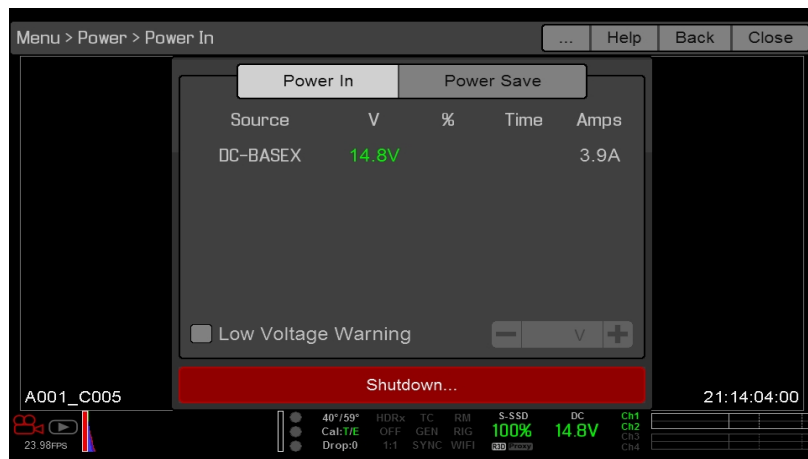

Figure: Power In Menu

DSMC2 MONSTRO OPERATION GUIDE

LOW VOLTAGE WARNING

When the Low Voltage Warning is enabled and the incoming voltage is less than the level you select, the camera shows a warning message and the Power Status indicator in the Lower Status Row turns red. This warning gives you the opportunity to change the battery or prepare for the camera to lose power. The warning continues to show until the incoming voltage is equal to or higher than the level you select.

RED does not recommend a specific voltage threshold, since that depends on the power draw of the attached accessories.

To enable the Low Voltage warning, follow the instructions below:

1. Go to **Menu > Power**.
2. Select the **Low Voltage Warning** check box.
3. Select the voltage level threshold. The camera warns you when the incoming voltage is less than this level.



Figure: Low Voltage Warning

POWER OUT

The Power Out menu shows the status of the power out ports on the attached devices. The statuses are:

- ▶ **N/A**: The device is not present.
- ▶ **OK**: The power out port is functional.
- ▶ **FAULT**: A short or overcurrent tripped the electronic fuse. Remove the device that is connected to the port, as it may be drawing too much power. Select **RESET** to clear the fault.

When the DSMC2 REDVOLT Expander is attached, you can see the current output of each power out port (in amps), and toggle those ports on/off.

DSMC2 MONSTRO OPERATION GUIDE

POWER SAVE

You can select the following power saving options (the default for each is Never):

- ▶ **Low Power Preview:** The camera uses a lower amount of power after the specified period of inactivity.
- ▶ **Sleep:** All monitors turn off and keys do not perform mapped actions after the specified period of inactivity. Tap the touchscreen or press a key to exit Sleep mode.
- ▶ **Auto Shutdown:** The camera turns off after the specified period of inactivity.

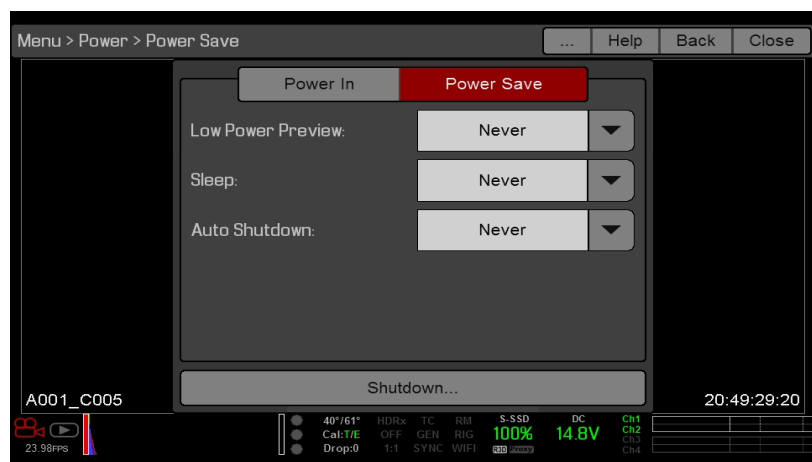

Figure: Power Save

SHUTDOWN

Shutdown controls are interlocked to prevent the camera from being accidentally turned off. For more information about different ways to turn off your camera, go to ["Turn Off the Camera" on page 45](#).

1. Go to **Menu > Power**.
2. Select **Shutdown**.

The Shutting Down... message displays and the camera turns off.

DSMC2 MONSTRO OPERATION GUIDE

PLAYBACK

To view clips from the SSD:

- ▶ Go to **Menu > Playback**.
- ▶ Press the **Record/Playback** toggle in the lower left corner of the touchscreen.

NOTE: The camera uses RGB color space in Playback mode by default, regardless of settings in Record mode. To playback clips in RAW mode, enable to RAW mode. For more information, go to ["Tools" on page 93](#).

PLAYBACK MENUS

In Playback mode, the menu is pared-down, so you cannot access all menus. Some menus offer different options.

MEDIA

Includes the Playlist menu, which lists all available clips on the attached SSD. You can perform the following actions:

- ▶ **➡** : Move selected clip to the Play List.
- ▶ **All ➡** : Move all clips to the Play List.

RECORD (EXIT)

Select **Record** to exit Playback mode. You can also press any button mapped to Record to exit Playback mode.

PLAYBACK STATUS BAR

Displays the progress of the clip during playback. When using the touchscreen, swipe your finger right and left to fast-forward and rewind the clip, respectively.

DSMC2 MONSTRO OPERATION GUIDE

PLAYBACK CONTROLS

GENERAL PLAYBACK CONTROLS

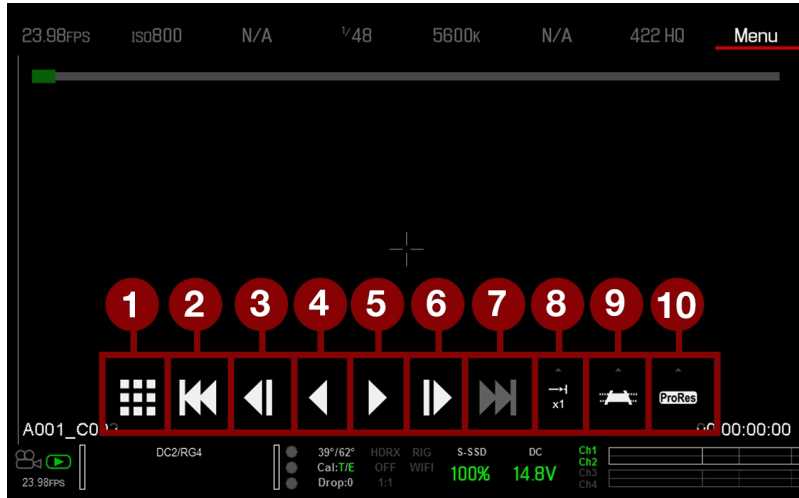

Figure: Playback Controls

#	CONTROL	DESCRIPTION
1	Clips	View clips as thumbnails
2	Load Previous Clip	Loads the previous clip in the playlist.
3	Frame-by-Frame Reverse	Moves through the clip frame-by-frame in reverse.
4	Reverse Play/Pause toggle	Plays clip in reverse, and toggles between play and pause.
5	Play/Pause toggle	Toggles between play and pause.
6	Frame-by-Frame Forward	Moves through the clip frame-by-frame.
7	Load Next Clip	Loads the next clip in the playlist.
8	Play Options	Displays the following subset of options: Play Once, Loop, Loop Playlist, and Playback Speed.
9	Marker Options	Displays the following subset of options: In Point, Remove In/Out Point, Out Point, Previous Marker, and Next Marker.
10	Apple ProRes Playback	Displays the following subset of options: R3D and ProRes

DSMC2 MONSTRO OPERATION GUIDE

PLAYBACK FILE TYPE



Figure: Playback Controls

#	CONTROL	DESCRIPTION
11	R3D Playback	Plays the R3D clip.
12	ProRes	Plays the Apple ProRes clip.

DSMC2 MONSTRO OPERATION GUIDE

PLAYBACK SPEED AND LOOPING



Figure: Playback Controls

#	CONTROL	DESCRIPTION
13	Play Once	Plays clip to the end, and does not repeat the clip.
14	Loop	Plays the clip on a loop.
15	Loop Playlist	Loops all clips in the playlist. To create a playlist, go to Menu > Media > Playlist , and move clips to the Play List field.
16	Playback Speed	Option to select x1, x2, x4, x8, or x16 playback speed.

DSMC2 MONSTRO OPERATION GUIDE

PLAYBACK MARKERS

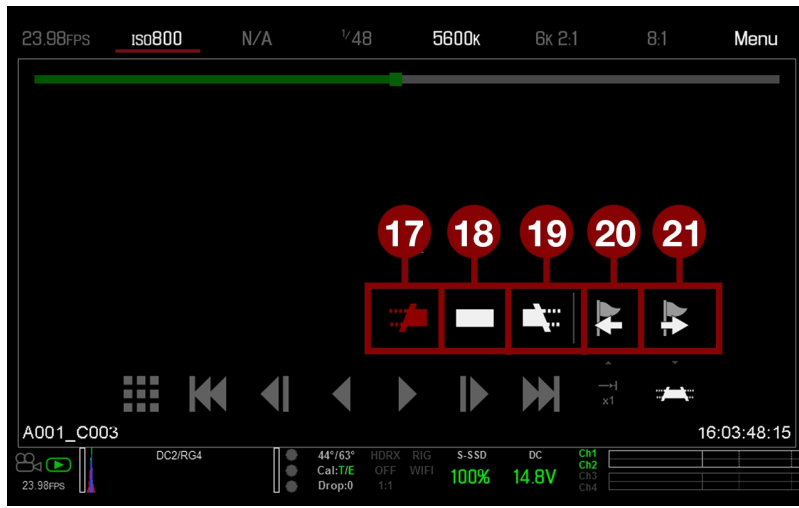

Figure: Playback Controls

#	CONTROL	DESCRIPTION
17	In Point	Sets a red In Point marker in the Playback Status Bar. Use an In Point marker in conjunction with an Out Point marker to play only a certain portion of a clip. The In/Out Point markers help when the clip is long and you want to focus on a particular segment.
18	Remove In/Out Point	Removes the In/Out Point markers and skips to the end of the clip.
19	Out Point	Sets a red Out Point marker in the Playback Status Bar. Use an Out Point marker in conjunction with an In Point marker to play only a certain portion of a clip. The In/Out Point markers help when the clip is long and you want to focus on a particular segment.
20	Previous Marker	Goes to the previous marked frame, which displays as a red line in the Playback Status Bar. Disabled when there are no marked frames.
21	Next Marker	Goes to the next marked frame, which displays as a red line in the Playback Status Bar. Disabled when there are no marked frames.

DSMC2 MONSTRO OPERATION GUIDE

MEDIA MENU

The Media Menu allows you to format and eject an SSD and to view and load clips on the SSD.

For more information about using media, see the [DSMC Media Operation Guide](http://www.red.com/downloads), available at www.red.com/downloads.

DEVICE

Format and eject (unmount) the SSD.

To see information about the SSD in the camera, select **More Info...**

CLIPS

View and load clips on the SSD in thumbnail view.



Figure: Clips Menu

DSMC2 MONSTRO OPERATION GUIDE

PRESETS MENU

The camera has the following presets:

- ▶ **Camera Presets:** These store and recall camera setup information, such as in-camera Looks, key mappings, I/O configurations, and more. The camera has a number of factory-installed presets.
- ▶ **Looks:** These allow you to save the specific color, image, white balance, and detail settings to be used for other projects. Looks that are generated in-camera display on the Camera Presets tab. Looks that are generated in REDCINE-X PRO and are imported to the camera display on the Looks tab.
- ▶ **Auto Presets:** These allow you to specify pre-selected presets for Startup, Preview, Motion, Stills, and Playback.

You can create custom presets and Looks. Presets and Looks can be stored on the camera or transferred to SSD, so that you can build a library of presets and Looks, or quickly copy presets and Looks from one camera to another via SSD.

- ▶ **Camera:** Presets or Looks that are saved internally on the camera.
- ▶ **Media:** Presets or Looks that are on the SSD in the path shown (for example, On Media: \presets:).

CAMERA PRESETS

NOTE: You cannot update, delete, or export factory-installed presets, which end with "(RED)".

PRESETS ACTIONS

- ▶ **Apply:** Apply the selected preset.
- ▶ **Create...:** Create a new preset using the current settings.
- ▶ **Update...:** Update the selected preset by allowing the parameter set to be modified and all the values to be updated to their current in-camera values.
- ▶ **Clone...:** Create a new preset using the selected preset as a template.
- ▶ **Delete:** Delete the selected preset.

EXPORT AND IMPORT PRESETS

Presets can be stored on the camera or transferred to SSD to be shared with other cameras. When exporting presets from camera to an SSD, the presets are saved to a folder on the SSD called "Presets". When importing presets from an SSD to camera, the presets must be stored on the SSD in a folder called "Presets".

- ▶ ➡ : Export selected preset from camera to SSD.
- ▶ ➡ **All:** Export all presets from camera to SSD.
- ▶ ⬅ : Import selected preset from SSD to camera.
- ▶ ⬅ **All:** Import all presets from SSD to camera.

DSMC2 MONSTRO OPERATION GUIDE

CREATE PRESETS

1. Set up the camera how you want the preset to be configured. For example, if you want to create a preset specifically for your zebra indicators, first configure the zebras the exact way that you want them to be in the preset.
2. Go to **Menu > Presets > Camera Presets**.
3. Select **Create**, or select an existing preset and select **Clone** or **Update**.
4. If creating a new preset, enter a name for the preset and select **OK**.
5. Select the following tabs to display different sets of preset options: **Display, Key, Look, Project, and System**.
6. Select the following:
 - ▶ ➡ : Add selected setting to the preset.
 - ▶ ➡ **All**: Add all settings to the preset.
 - ▶ ⬅ **X**: Remove selected setting from the preset.
7. Select **Create**.

The preset is saved and stored in the camera.

LOOKS

A Look is made up of the following settings: Color, Gain, FLUT, Sharpness, Curves, Color Space, Gamma, Color Temperature, and LGG (Lift, Gamma, Gain). These settings are configured either in-camera or in REDCINE-X PRO®.

CREATE AND MANAGE IN-CAMERA LOOKS

Create in-camera looks in the **Menu > Presets > Camera Presets** tab. Modify and manage the in-camera Looks the same way as any other presets created in the Camera Presets tab. For more information, go to "[Camera Presets](#)" on the previous page.

IMPORT LOOKS FROM REDCINE-X PRO

1. While your SSD is mounted to your computer, create a folder on the SSD called **Looks**.
2. Save your RMD files (that have been exported from REDCINE-X PRO) to the **Looks** folder on the SSD.
3. Eject the SSD from your computer.
4. Mount the SSD to your camera.
5. Go to **Presets > Looks**.
6. Select one (1) of the following:
 - ▶ ⬅ : Import selected Look from SSD to camera.
 - ▶ ⬅ **All**: Import all Looks from SSD to camera.

For more information, see the [REDCINE-X PRO: Saving Looks to Camera](#) video tutorial, available at www.red.com/learn/workflow/redcine-x-saving-looks-camera.

DSMC2 MONSTRO OPERATION GUIDE

MANAGE IMPORTED LOOKS

Manage Looks imported from REDCINE-X PRO in the **Presets > Looks** tab. When exporting Looks from camera to SSD, the Looks are saved to a folder on the SSD called “Looks”.

You can perform the following actions with imported Looks:

- ▶ ➡ : Export selected Looks from camera to SSD.
- ▶ ➡ **All**: Export all Looks from camera to SSD.
- ▶ **Apply**: Apply the selected Look.
- ▶ **Delete**: Delete the selected Look.

AUTO PRESETS

- ▶ **Startup**: The selected preset is applied every time the camera is turned on.
- ▶ **Motion**: The selected preset is applied every time Motion mode is enabled.
- ▶ **Stills**: The selected preset is applied every time Stills mode is enabled.
- ▶ **Playback**: The selected preset is applied every time the camera enters Playback mode.

DSMC2 MONSTRO OPERATION GUIDE

SETTINGS MENU

PROJECT

The Project menu includes settings that define the recorded file, including recording frame rate, exposure, and format.

FRAME RATE

RECORDING FRAME RATE

Select the recording frame rate (also referred to as the capture frame rate). The recording frame rate is the number of frames per second (fps) that are recorded. The recording frame rate is different from the project time base, which is the rate at which the footage will be played back.

The default recording frame rate is 23.98 fps. If you change the project time base, the recording frame rate automatically changes its value to match the project time base.

The maximum frame rate for each format is determined by several factors, including project time base, REDCODE, and Look Around.

PROJECT TIME BASE

Select the project time base. The project time base is the rate at which the footage will be played back. The project time base displays in the lower left corner of the display.

The following project time bases are available:

- ▶ 23.98 fps (Default)
- ▶ 24.00 fps
- ▶ 25.00 fps
- ▶ 29.97 fps
- ▶ 30.00 fps
- ▶ 47.95 fps
- ▶ 48.00 fps
- ▶ 50.00 fps
- ▶ 59.94 fps
- ▶ 60.00 fps

VARISPEED

When a recording frame rate other than the current project time base is selected, the fps text turns yellow and the word Varispeed replaces the Audio Meter in the lower right corner of the display.

Starting with firmware v6.4, the camera supports recording audio in Varispeed mode. For more information, go to ["Record Audio in Varispeed Mode" on page 170](#).

DSMC2 MONSTRO OPERATION GUIDE

EXPOSURE/SHUTTER

Select the exposure (shutter speed / shutter angle) of each frame. You can change exposure while recording.

Decreasing shutter speed increases the amount of time that light hits the sensor, which increases exposure and motion blur of moving objects. Increasing shutter speed decreases the amount of time that light hits the sensor, which decreases exposure and motion blur of moving objects.

The Upper Status Row displays the exposure as either shutter speed or shutter angle. For more information, go to ["Exposure" on page 98](#).

If the camera is able to achieve the target exposure, the exposure value displays in white. If the camera is unable to achieve the target exposure, the exposure value displays in yellow, and the camera uses the closest available exposure.

NOTE: If using speed ramp mode, select an exposure that is valid for each ramp target frame rate. If the camera ramps to a frame rate that is incompatible with the current exposure, the exposure changes to the longest exposure possible for the frame rate. For more information, go to ["Speed Ramp Mode" on page 125](#).

NOTE: You cannot change the exposure when HDR is enabled.

INTEGRATION TIME

Enter the exposure value as a shutter speed (1/xx sec).

The slowest shutter speed is 1/(recording frame rate). For example, if the recording frame rate is 24 fps, the slowest available shutter speed is 1/24 sec. The fastest shutter speed is 1/131,579 sec. The default shutter speed is 1/48 sec.

SHUTTER ANGLE

Enter the exposure value as a shutter angle (xx°). The shutter angle range is 1.000° to 360.000°. The default shutter angle is 180.000°.

EXPOSURE CONVERSIONS

The table below lists common shutter speed and shutter angle equivalents. The calculations in the table use a recording frame rate of 24 fps.

SHUTTER SPEED (1/XX SEC)	SHUTTER ANGLE (°)	SHUTTER SPEED (1/XX SEC)	SHUTTER ANGLE (°)
1/32	270	1/120	72
1/48	180	1/192	45
1/50	172.8	1/384	22.5
1/60	144	1/696	12.4
1/96	90	1/1000	8.6

CONVERT SHUTTER SPEED TO SHUTTER ANGLE

Shutter Angle = (Shutter Speed x Frame Rate x 360)

Example: $(1/48 \times 24 \times 360) = 180$

CONVERT SHUTTER ANGLE TO SHUTTER SPEED

Shutter Speed = $1/(\text{Frame Rate} \times 360/\text{Angle})$

Example: $1/(24 \times 360/180) = 1/48$

DSMC2 MONSTRO OPERATION GUIDE

TIMECODE

NOTE: Using timecode requires ports that are only available on select DSMC2 expanders and modules. For more information, go to ["Input/Output Connectors" on page 218](#).

RED cameras use non-drop frame timecode. For more information about timecode, go to ["Timecode, Genlock, Multi-Camera Setup" on page 172](#).

TIMECODE DISPLAY MODE

- ▶ **Time of Day (TOD):** Displays the time of day (HH:MM:SS:FF). TOD timecode runs continuously and is not affected by recording.
- ▶ **Edge:** Edge timecode is continuous between clips, meaning that when recording starts, timecode begins, and when recording stops, timecode stops. By default, Edge timecode default begins at 01:00:00:00, but can be configured in the Media menu when formatting an SSD.

TIMECODE SOURCE

- ▶ **RTC:** Uses the internal Real Time Clock as the timecode counter source.
- ▶ **External:** Uses the timecode from an external device connected to the timecode connector on the camera.

SLATE

Use the Slate menu to add metadata to clips. After configuring the following fields, the information populates in the Media menu when formatting media:

- ▶ Camera ID
- ▶ Camera Position

NOTE: The scene name is limited to eight (8) characters.

AUTO-INCREMENT TAKE

To automatically increment the take number when the camera stops recording, follow the instructions below:

1. Go to **Menu > Settings > Project > Slate > Scene**.
2. Enter a name in the **Scene** box.
3. Enter a value in the **Take** box.

AUTO SLATE

Frame values for **Auto Head Frames** and **Auto Tail Frames** on the **Auto Slate** tab, these values only show in-camera. The Auto Head Frames and Auto Tail Frames metadata values are currently disabled in REDCINE-X PRO.

DSMC2 MONSTRO OPERATION GUIDE

FORMAT

To access the Format menu, go to **Menu > Settings > Project > Format**.

The available aspect ratios are determined by the selected resolution.

After selecting format settings, select **Set Format**.

When you lower the resolution on a camera, only a portion of the sensor is used. The camera does not downscale from full format when recording RAW.

DSMC2 MONSTRO FORMATS

The table below describes the formats for DSMC2 MONSTRO and DSMC2 MONSTRO Monochrome.

The table below omits rows for the anamorphic formats, since the pixel dimensions for each anamorphic format and the corresponding non-anamorphic format are the same. For more information, go to ["Anamorphic" on page 122](#).

Using a 6:5 aspect ratio at 2x anamorphic gives you a 2.4:1 aspect ratio.

RESOLUTION	DIMENSION (PIXELS)		DIMENSIONS (MM)		
	WIDTH	HEIGHT	WIDTH	HEIGHT	DIAGONAL
8K FF	8192	4320	41.0	21.6	46.3
8K 2:1	8192	4096	41.0	20.5	45.8
8K 2.4:1 (WS)	8192	3456	41.0	17.3	44.5
8K 16:9 (HD)	7680	4320	38.4	21.6	44.1
8K 14:9	6720	4320	33.6	21.6	39.9
8K 3:2	6480	4320	32.4	21.6	38.9
8K 6:5	5184	4320	25.9	21.6	33.7
8K 8:9	3840	4320	19.2	21.6	28.9
8K 4:1	8192	2048	41.0	10.2	42.2
8K 8:1	8192	1024	41.0	5.1	41.3
7.5K FF	7680	4080	38.4	20.4	43.5
7.5K 2:1	7680	3840	38.4	19.2	42.9
7.5K 2.4:1 (WS)	7680	3240	38.4	16.2	41.7
7.5K 16:9 (HD)	7296	4104	36.5	20.5	41.9
7.5K 4:1	7680	1920	38.4	9.6	39.6
7.5K 8:1	7680	960	38.4	4.8	38.7
7K FF	7168	3780	35.8	18.9	40.5
7K 2:1	7168	3584	35.8	17.9	40.1
7K 2.4:1 (WS)	7168	3024	35.8	15.1	38.9
7K 16:9 (HD)	6720	3780	33.6	18.9	38.6

DSMC2 MONSTRO OPERATION GUIDE

RESOLUTION	DIMENSION (PIXELS)		DIMENSIONS (MM)		
	WIDTH	HEIGHT	WIDTH	HEIGHT	DIAGONAL
7K 8:9	3360	3780	16.80	18.90	25.29
7K 6:5	4536	3780	22.7	18.9	29.5
7K 4:1	7168	1792	35.8	9.0	36.9
7K 8:1	7168	896	35.8	4.5	36.1
6.5K FF	6656	3536	33.3	17.7	37.7
6.5K 2:1	6656	3328	33.3	16.6	37.2
6.5K 2.4:1 (WS)	6656	2808	33.3	14.0	36.1
6.5K 16:9 (HD)	6144	3456	30.7	17.3	35.2
6.5K 4:1	6656	1664	33.3	8.3	34.3
6.5K 8:1	6656	832	33.3	4.2	33.5
6K FF	6144	3240	30.7	16.2	34.7
6K 2:1	6144	3072	30.7	15.4	34.3
6K 2.4:1 (WS)	6144	2592	30.7	13.0	33.
6K 16:9 (HD)	5760	3240	28.8	16.2	33.0
6K 3:2	5760	3840	28.8	19.2	34.6
6K 4:3	5760	4320	28.8	21.6	36.0
6K 8:9	2880	3240	14.40	16.20	21.67
6K 6:5	3888	3240	19.4	16.2	25.3
6K 4:1	6144	1536	30.7	7.7	31.7
6K 8:1	6144	768	30.7	3.8	31.0
5.5K FF	5632	2948	28.2	14.7	31.8
5.5K 2:1	5632	2816	28.2	14.1	31.5
5.5K 2.4:1 (WS)	5632	2376	28.2	11.9	30.6
5.5K 16:9 (HD)	5376	3024	26.9	15.1	30.8
5.5K 4:1	5632	1408	28.2	7.0	29.0
5.5K 8:1	5632	704	28.2	3.5	28.4
5K FF	5120	2700	25.6	13.5	29.0
5K 2:1	5120	2560	25.6	12.8	28.6
5K 2.4:1 (WS)	5120	2160	25.6	10.8	27.8

DSMC2 MONSTRO OPERATION GUIDE

RESOLUTION	DIMENSION (PIXELS)		DIMENSIONS (MM)		
	WIDTH	HEIGHT	WIDTH	HEIGHT	DIAGONAL
5K 16:9 (HD)	4800	2700	24.0	13.5	27.5
5K 4:3	5120	3840	25.60	19.20	32.00
5K 8:9	2400	2700	12.00	13.50	18.06
5K 6:5	3240	2700	16.2	13.5	21.1
5K 4:1	5120	1280	25.6	6.4	26.4
5K 8:1	5120	640	25.6	3.2	25.8
4.5K FF	4608	2412	23.0	12.1	26.0
4.5K 2:1	4608	2304	23.0	11.5	25.8
4.5K 2.4:1 (WS)	4608	1944	23.0	9.7	25.0
4.5K 16:9 (HD)	4224	2376	21.1	11.9	24.2
4.5K 3:2	4320	2880	21.6	14.4	26.0
4.5K 4:3	4320	3240	21.6	16.2	27.0
4.5K 5:4	4320	3456	21.6	17.3	27.7
4.5K 4:1	4608	1152	23.0	5.8	23.7
4.5K 8:1	4608	576	23.0	2.9	23.2
4K FF	4096	2160	20.5	10.8	23.2
4K 2:1	4096	2048	20.5	10.2	22.9
4K 2.4:1 (WS)	4096	1728	20.5	8.6	22.2
4K 16:9 (HD)	3840	2160	19.2	10.8	22.0
4K 3:2	3840	2560	19.2	12.8	23.1
4K 4:3	3840	2880	19.2	14.4	24.0
4K 5:4	3840	3072	19.2	15.4	24.6
4K 8:9	1920	2160	9.60	10.80	14.45
4K 6:5	2592	2160	13.0	10.8	16.9
4K 4:1	4096	1024	20.5	5.1	21.1
4K 8:1	4096	512	20.5	2.6	20.6
4K 1:1	4320	4320	21.6	21.6	30.5
3.5K FF	3584	1876	17.9	9.4	20.2
3.5K 2:1	3584	1792	17.9	9.0	20.0

DSMC2 MONSTRO OPERATION GUIDE

RESOLUTION	DIMENSION (PIXELS)		DIMENSIONS (MM)		
	WIDTH	HEIGHT	WIDTH	HEIGHT	DIAGONAL
3.5K 2.4:1 (WS)	3584	1512	17.9	7.6	19.4
3.5K 16:9 (HD)	3456	1944	17.3	9.7	19.8
3.5K 3:2	3360	2240	16.8	11.2	20.2
3.5K 4:3	3360	2520	16.8	12.6	21.0
3.5K 5:4	3360	2688	16.8	13.4	21.5
3.5K 4:1	3584	896	17.9	4.5	18.5
3.5K 8:1	3584	448	17.9	2.2	18.1
3K FF	3072	1620	15.4	8.1	17.4
3K 2:1	3072	1536	15.4	7.7	17.2
3K 2.4:1 (WS)	3072	1296	15.4	6.5	16.7
3K 16:9 (HD)	2880	1620	14.4	8.1	16.5
3K 3:2	2880	1920	14.4	9.6	17.3
3K 4:3	2880	2160	14.4	10.8	18.0
3K 5:4	2880	2304	14.4	11.5	18.4
3K 6:5	1944	1620	9.7	8.1	12.7
3K 4:1	3072	768	15.4	3.8	15.8
3K 8:1	3072	384	15.4	1.9	15.5
2.5K FF	2560	1340	12.8	6.7	14.4
2.5K 2:1	2560	1280	12.8	6.4	14.3
2.5K 2.4:1 (WS)	2560	1080	12.8	5.4	13.9
2.5K 16:9 (HD)	2304	1296	11.5	6.5	13.2
2.5K 3:2	2400	1600	12.0	8.0	14.4
2.5K 4:3	2400	1800	12.0	9.0	15.0
2.5K 5:4	2400	1920	12.0	9.6	15.4
2.5K 4:1	2560	640	12.8	3.2	13.2
2.5K 8:1	2560	320	12.8	1.6	12.9
2K FF	2048	1080	10.2	5.4	11.6
2K 2:1	2048	1024	10.2	5.1	11.4
2K 2.4:1 (WS)	2048	864	10.2	4.3	11.1

DSMC2 MONSTRO OPERATION GUIDE

RESOLUTION	DIMENSION (PIXELS)		DIMENSIONS (MM)		
	WIDTH	HEIGHT	WIDTH	HEIGHT	DIAGONAL
2K 16:9 (HD)	1920	1080	9.6	5.4	11.0
2K 3:2	1920	1280	9.6	6.4	11.5
2K 4:3	1920	1440	9.6	7.2	12.0
2K 5:4	1920	1536	9.6	7.7	12.3
2K 6:5	1296	1080	6.5	5.4	8.4
2K 4:1	2048	512	10.2	2.6	10.6
2K 8:1	2048	256	10.2	1.3	10.3

DSMC2 MONSTRO OPERATION GUIDE

ANAMORPHIC

Select an **Anamorphic** setting, if applicable. The anamorphic setting de-squeezes the image on the monitor and marks the footage as anamorphic in the clip metadata. When you open the clip in REDCINE-X PRO, the program automatically de-squeezes the image. The available anamorphic settings depend on your camera type.

The camera supports anamorphic 1.3x and 2x with each format.

The camera also supports anamorphic 1.25x for 6K full format and 8K full format.

DE-SQUEEZED RESOLUTION AND DE-SQUEEZED ASPECT RATIO

When you enable anamorphic, both the actual format and the de-squeezed format display at the bottom of the Format menu. To view the actual format and the de-squeezed format, go to **Menu > Settings > Project > Format > Format**.

When anamorphic is enabled, the camera does not crop the sensor image, so the recorded image has the same resolution and dimensions as the corresponding non-anamorphic format.

After de-squeezing the footage in post production, the resulting footage has a different format than the original recorded image. The format of the de-squeezed footage is the second format (resolution and aspect ratio) that displays on the Format menu.

Since the camera does not crop the image, you will have additional horizontal area to frame the image. Then, crop or scale the footage to the intended aspect ratio.

SHORT-CUT TO INDUSTRY-STANDARD ANAMORPHIC FORMATS

To quickly access industry-standard anamorphic formats, go to **Menu > Settings > Project > Format > Anamorphic**. The Anamorphic tab is a short-cut to all of the industry-standard anamorphic formats, so that you can easily select the most common anamorphic formats.

The Anamorphic tab lists the anamorphic formats for every format with a 6:5, 5:4, or 4:3 aspect ratio.

NOTE: The Anamorphic tab only lists industry-standard anamorphic formats. To access all of the anamorphic and non-anamorphic formats, go to **Menu > Settings > Project > Format > Format**.

DSMC2 MONSTRO OPERATION GUIDE

SENSOR (FLIP/MIRROR SCAN DIRECTION)

The Flip/Mirror Scan Direction feature rotates the image 180°, both on the monitor and in the recorded R3D file. Normally, the sensor scans the image from the top to the bottom. When the Flip/Mirror Scan Direction feature is enabled, the sensor scan direction reverses, and the sensor scans the image from the bottom to the top.

The Flip/Mirror Scan Direction feature is intended for multi-camera arrays when all sensors are synchronized, and at least one (1) camera is mounted upside-down. Using this feature is helpful for matching the line scan direction for the cameras in the array.

To enable the Flip/Mirror Scan Direction feature, follow the instructions below:

1. Go to **Menu > Settings > Project > Sensor**.
2. Select the **Flip/Mirror Scan Direction** check box.

The camera rotates the image 180° on the monitor and in the recorded R3D file.



Figure: Flip/Mirror Scan Direction

DSMC2 MONSTRO OPERATION GUIDE

RECORDING

The Recording menu includes: Mode, Codec, Frame Processing, Pre-Record, and Indicator.

MODE

You can select the following recording modes: Continuous Record, Internal Timelapse Timer, Frame Trigger, REDCODE Burst, Speed Ramp Mode, Multi-Shot, and Motion + Stills.

NOTE: Audio is recorded only in Continuous Record and Motion + Stills modes.

STORAGE

You can select the following storage locations:

- ▶ **Local:** Stores footage directly to an SSD
- ▶ **Network:** Stores footage to a network
- ▶ **External:** Stores footage to an external device

NOTE: HDRX is disabled in Network Storage mode.

NOTE: In External storage, you can only select Continuous Record and Motion + Stills recording modes.

CONTINUOUS RECORD

NOTE: This mode is not available in Stills mode.

Continuous Record is the “normal” recording mode. The camera continuously records frames at the current recording frame rate. You can limit each recording to a specific amount of frames using the Limit Recording to setting.

INTERNAL TIMELAPSE TIMER

NOTE: This mode is not available in Stills mode.

NOTE: Audio is not recorded in Internal Timelapse Timer mode.

In Internal Timelapse Timer mode, the camera records a specified number of frames at a specified interval. The current recording frame rate determines the timing of the frames per pulse.

For example, in Internal Timelapse Timer mode, you can choose to record a total amount of 1000 frames, and take 1 frame every 4.67 seconds. After recording 1000 frames (which takes 4,670.00 seconds), the recording process stops.

To use Internal Timelapse Timer mode, follow the instructions below:

1. Go to **Menu > Settings > Recording > Mode**.
2. Select **Internal Timelapse Timer** from the **Mode** drop-down menu.
3. Use the **Limit Recording to** fields to set the recording to end at a predefined frame limit (optional).
4. Select the number of frames to be captured in the **Record** field.
5. Select the time interval from the **Interval** field (range is 1–3,599 sec). The Interval setting specifies the frequency at which the frame or group of frames is captured.
6. Close the menu.
7. Start recording to start the interval.

The overlay displays the number of frames recorded out of the total amount of frames.

DSMC2 MONSTRO OPERATION GUIDE

FRAME TRIGGER

NOTE: This mode is not available in Stills mode.

NOTE: Audio is not recorded in Frame Trigger mode.

In Frame Trigger mode, the camera records the specified number of frames for each external trigger. This mode limits the REDCODE based on sustainable record rates.

To use Frame Trigger mode, follow the instructions below:

1. Go to **Menu > Settings > Recording > Mode**.
2. Select **Frame Trigger** from the **Mode** drop-down menu.
3. Use the **Limit Recording to** fields to set the recording to end at a predefined frame limit (optional).
4. Select a **Pre Count** and **Post Count**. For more information, go to ["Pre Count and Post Count" on the next page](#).
5. Close the menu.
6. Start recording.

The overlay displays the number of frames recorded out of the total amount of frames.

NOTE: There may be a delay between receiving the external trigger and capturing the next frame(s). The delay may be as long one (1) frame period at the current recording frame rate. To completely synchronize frames to an external trigger, set **Sensor Sync Mode** to **MoCo**. For more information, go to ["Sync" on page 149](#).

SPEED RAMP MODE

NOTE: This mode is not available in Stills mode.

NOTE: Audio is not recorded in Speed Ramp mode.

Speed Ramp mode lets you program the current recording frame rate to transition to different recording frame rates during recording.

1. Go to **Menu > Settings > Recording > Mode**.
2. Select **Speed Ramp Mode** from the **Mode** drop-down menu.
3. Use the **Limit Recording to** fields to set the recording to end at a predefined frame limit (optional).
4. Select a ramp target:
 - ▶ **Ramp A/B/C/D:** Each ramp target is tied to a specific Target/Duration combination.
 - ▶ **Ramp Reset:** Ramp to the starting frame rate with the specified Duration.
5. Set the **Target** frame rate.
6. Set the **Duration**, which is how long it takes to transition from the current frame rate to the target frame rate.
7. Go to **Menu > Settings > Setup > Keys** and program a key to one of the following functions:
 - ▶ Record: Start Speed Ramp A/B/C/D
 - ▶ Record: Start Speed Ramp Reset
8. Start recording.
9. To start speed ramp, press the key that you have mapped to start the speed ramp.

The frame rate transitions to the target frame rate during the duration you set up.

NOTE: If using speed ramp mode, select an exposure that is valid for each ramp target frame rate. If the camera ramps to a frame rate that is incompatible with the current exposure, the exposure changes to the longest exposure possible for the frame rate.

DSMC2 MONSTRO OPERATION GUIDE

REDCODE BURST

NOTE: This mode is not available in Stills mode.

NOTE: Audio is not recorded in REDCODE Burst mode.

In REDCODE Burst mode, the camera can record at a lower compression (REDCODE) for the specified amount of frames. When REDCODE Burst mode is enabled and recording starts, the camera captures a “burst” of frames at the lower REDCODE, and then continues to record at the next available REDCODE. To add more bursts to clips during recording, press any key mapped to “Record: Mark Frame”.

To use REDCODE Burst mode, follow the instructions below:

1. Go to **Menu > Settings > Recording > Mode**.
2. Select **REDCODE Burst** from the **Mode** drop-down menu.
3. Use the **Limit Recording to** fields to set the recording to end at a predefined frame limit (optional).
4. Select a **Pre Count** and **Post Count**. For more information, go to "[Pre Count and Post Count](#)" below.
5. Close the menu.
6. Start recording.



Figure: REDCODE Burst

PRE COUNT AND POST COUNT

When Frame Trigger or Burst mode is enabled, select the number of frames for the Pre Count and Post Count:

- ▶ **Pre Count:** The camera captures the frame cache from the time preceding the marker.
- ▶ **Post Count:** The camera captures the remaining frame cache after the marker.

The maximum frame counts are listed in the Available column, and are based on format and REDCODE.

DSMC2 MONSTRO OPERATION GUIDE

MULTI-SHOT

NOTE: The camera does not sync timecode in Multi-Shot mode.

NOTE: This mode is available in Motion mode, but is only recommended in Stills mode.

NOTE: Audio is not recorded in Multi-Shot mode.

Multi-Shot mode removes restrictions on Recording Frame Rate and REDCODE, allowing you to shoot at a high resolution, high frame rate, and low compression. These restrictions are removed because the camera records first to the camera's memory, and then offloads (while recording) to SSD after the camera's buffer fills up. Since the camera records only as fast as the buffer can transfer data, frames are dropped from the clip.

Multi-Shot mode has two sub-modes:

- ▶ Basic Multi-Shot mode
- ▶ Advanced Multi-Shot mode

BASIC MULTI-SHOT MODE

In Basic Multi-Shot mode, you can record a one-frame clip by pressing a Record key, or you can continuously record frames by holding a Record key. This mode is the easiest way to shoot stills, but there is some latency (about 700 milliseconds) when you press Record.

This mode only involves the Record key on the media bay.

Pressing the PWR/REC key on the camera initiates Advanced Multi-Shot mode.

To use Basic Multi-Shot mode, perform one of the following:

- ▶ Press a **Record** key to record a one-frame clip.
- ▶ Press and hold a **Record** key to start a new clip and continuously add frames to that clip. Release the **Record** key to stop adding frames and end the clip.

ADVANCED MULTI-SHOT MODE

In this mode, the camera is continuously recording, but is not saving frames. This eliminates the delay you get in Basic Multi-Shot mode. Since the camera is continuously recording, the camera requires the same amount of power it does during Continuous Record (as opposed to Preview mode). Unlike Basic mode, all frames are added to one (1) clip, instead of to separate clips.

To use Advanced Multi-Shot mode, follow the instructions below:

1. Press the **PWR/REC** key on the camera to start a new clip. This initial press adds one (1) frame to the clip.
2. Press the **Record** key on the media bay to add frames to the clip:
 - ▶ Press a **Record** key once to add a few frames to the clip. (The number of frames varies, and depends on the buffer.)
 - ▶ Press and hold a **Record** key to continuously add frames; release the **Record** key to stop adding frames.
3. Press the **PWR/REC** key on the camera to end the clip.

NOTE: You cannot shut down the camera until you end the clip.

DSMC2 MONSTRO OPERATION GUIDE

ENABLE MULTI-SHOT MODE

To enable Multi-Shot mode, follow the instructions below:

1. Set the camera to Stills mode. For more information, go to ["Camera Mode" on page 65](#).
2. Go to **Menu > Settings > Recording > Mode**.
3. Select **Multi-Shot** from the **Mode** drop-down menu.
4. Use the **Limit Recording to** fields to set the recording to end at a predefined frame limit (optional).
5. Close the menu.

MOTION + STILLS

NOTE: This mode is available in Motion mode, but is only recommended in Stills mode.

Motion + Stills mode is identical to Continuous Record, except that when you initiate recording by pressing the PWR/REC key on the camera, all other Record keys mark frames for the duration of the clip. (If you initiate recording by pressing any other Record key, you can press any key mapped to "Record: Mark Frame" to mark stills.)

To use Motion + Stills mode, follow the instructions below:

1. Set the camera to Stills mode. For more information, go to ["Camera Mode" on page 65](#).
2. Go to **Menu > Settings > Recording > Mode**.
3. Select **Motion + Stills** from the **Mode** drop-down menu.
4. Use the **Limit Recording to** fields to set the recording to end at a predefined frame limit (optional).
5. Close the menu.
6. Press the **PWR/REC** key on the camera to start recording.
7. Press the **Record** key on the media bay to mark a frame.
8. Press the **PWR/REC** key on the camera to stop recording.

DSMC2 MONSTRO OPERATION GUIDE

APPLE PRORES INFORMATION

By default, the camera records all videos and stills in the REDCODE RAW file format (records R3D files). You also have the option to record Apple ProRes files. This section provides general information about recording Apple ProRes files with the camera:

NOTE: If Look Around is enabled, the Look Around area is recorded in the Apple ProRes file.

- ▶ Selecting a Recording Frame Rate that is not supported by Apple ProRes has the following effects:
 - ▶ **2K Apple ProRes over 120 FPS:** The QuickTime file will be sub-sampled.
 - ▶ **4K Apple ProRes over 60 FPS:** Apple ProRes is disabled.
 - ▶ **4K Apple ProRes + R3D over 29.97 FPS:** Apple ProRes is disabled.
- ▶ The camera cannot record Apple ProRes when Pre-Record is enabled.
- ▶ The camera can record Apple ProRes only when either of the following recording modes is enabled:
 - ▶ Continuous Record
 - ▶ Motion + Stills
- ▶ Recording 4K Apple ProRes is only available:
 - ▶ When recording to Apple ProRes only
 - ▶ When recording to the following codecs:
 - ▶ Apple ProRes 422
 - ▶ Apple ProRes 422 HQ
 - ▶ Apple ProRes 422 LT
- ▶ If HDRX[®] is enabled, only the selected monitor track is recorded to the QuickTime files. For more information, go to "[HDRX Menu](#)" on page 136.
- ▶ RED recommends performing a Secure Format before recording Apple ProRes. For more information, see the [DSMC Media Operation Guide](#), available at www.red.com/downloads.
- ▶ QuickTime files have the same metadata that is in the REDCODE RAW files. The metadata is per clip, and not per frame. At this time, there is no tool for extracting that metadata from the QuickTime files.
- ▶ You can select any resolution. When recording Apple ProRes, the camera scales that format to the Resolution (2K) selected in the Codec menu. The field of view is maintained in the QuickTime file; the image is not cropped.
- ▶ If recording 4K Apple ProRes and the Resolution is less than 4K, the image is scaled to 2K.
- ▶ For more information about Apple ProRes, including the data rates for each codec, see the [Apple Support](#) site.
- ▶ To record Apple ProRes files, go to "[Select Record File Format](#)" on page 133.

APPLE PRORES DESCRIPTION

The table below describes each supported Apple ProRes codec.

NAME	CHROMA SAMPLING
ProRes 422 HQ	YCbCr 4:2:2
ProRes 422	YCbCr 4:2:2
ProRes 422 LT	YCbCr 4:2:2
ProRes 4444 XQ	YCbCr 4:4:4
ProRes 4444	YCbCr 4:4:4

DSMC2 MONSTRO OPERATION GUIDE

FILE STRUCTURE OF RECORDED APPLE PRORES FILES

When recording R3D + Apple ProRes, this is the file structure of the recorded files on the SSD (when the SSD is formatted as FAT32):

- ▶ .RDM Folder
 - ▶ .RDC Folder
 - ▶ .mov
 - ▶ .R3D
 - ▶ .rtn (RED Thumbnail file)

NOTE: The camera creates multiple .mov files, similar to how the camera creates multiple R3D files.

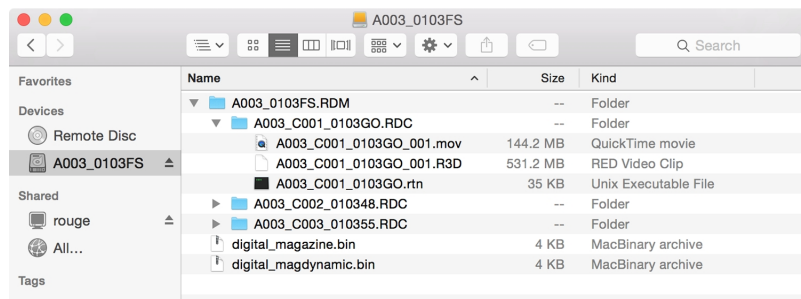

Figure: File Structure: R3D + Apple ProRes

When recording Apple ProRes only, this is the file structure of the recorded files on the SSD (when the SSD is formatted as FAT32):

- ▶ .RDM Folder
 - ▶ .RDC Folder
 - ▶ .mov

NOTE: The camera creates multiple .mov files, similar to how the camera creates multiple R3D files.

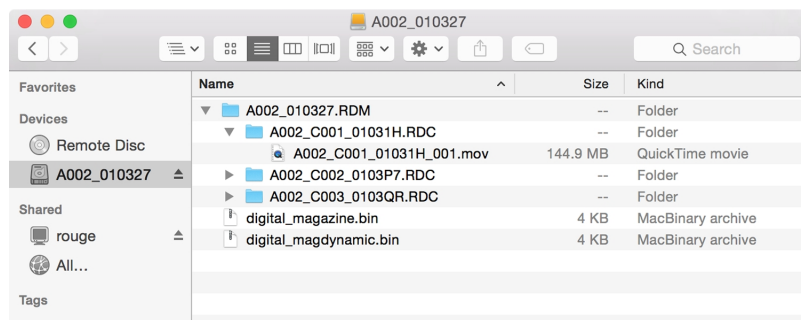

Figure: File Structure: Apple ProRes

DSMC2 MONSTRO OPERATION GUIDE

AVID DNxHD AND AVID DNxHR INFORMATION

By default, the camera records all videos and stills in the REDCODE RAW file format (records R3D files). You also have the option to record to Avid DNxHD and Avid DNxHR (records .mxf files). This section provides general information about recording Avid DNxHD/HR with the camera:

NOTE: If Look Around is enabled, the Look Around area is recorded in the Avid DNxHD/HR file.

NOTE: Enabling Look Around effects the aspect ratio of the scaled file, regardless of the recorded area.

- ▶ Selecting a Recording Frame Rate that is not supported by Avid DNxHD/HR causes the codec file to be sub-sampled to half of the selected Recording Frame Rate.
- ▶ The camera cannot record Avid DNxHD/HR when Pre-Record is enabled.
- ▶ The camera can record Avid DNxHD/HR only when either of the following recording modes is enabled:
 - ▶ Continuous Record
 - ▶ Motion + Stills
- ▶ If HDRX[®] is enabled, only the selected monitor track is recorded to the Avid DNxHD/HR file. For more information, go to "[HDRX Menu](#)" on page 136
- ▶ RED recommends performing a Secure Format before recording Avid DNxHD/HR. For more information, see the [DSMC Media Operation Guide](#), available at www.red.com/downloads.
- ▶ The .mxf files have the same metadata that is in the REDCODE RAW files. The metadata is per clip, and not per frame. At this time, there is no tool for extracting that metadata from the .mxf files.
- ▶ You can select any resolution. When recording Avid DNxHD/HR, the camera scales that format to the Resolution (2K or 4K) selected in the Codec menu. The field of view is maintained in Avid DNxHD/HR; the image is not cropped.
- ▶ If recording 4K Avid DNxHD/HR and the Resolution is less than 4K, the image is scaled to 2K.
- ▶ For more information about Avid DNxHD/HR, see the [Avid](#) site.
- ▶ To record Avid DNxHD/HR, go to "[Select Record File Format](#)" on page 133.

AVID DNxHD AND AVID DNxHR DESCRIPTION

The table below describes each Avid DNxHD/HR codec.

NAME	CODEC ID	MAXIMUM BITS	COLOR
DNxHR HQX	1271	12 bit	YCbCr 4:2:2
DNxHR HQ	1272	8 bit	YCbCr 4:2:2
DNxHR SQ	1273	8 bit	YCbCr 4:2:2
DNxHR 444	1270	12 bit	RGB 4:4:4
DNxHD 444	1256	10 bit	RGB 4:4:4
DNxHD HQX	1235	10 bit	YCbCr 4:2:2
DNxHD HQ	1238	8 bit	YCbCr 4:2:2
DNxHD SQ	1237	8 bit	YCbCr 4:2:2

DSMC2 MONSTRO OPERATION GUIDE

FILE STRUCTURE OF RECORDED AVID CODEC FILES

When recording R3D + Avid DNxHD/HR, this is the file structure of the recorded files on the SSD (when the SSD is formatted as FAT32):

- ▶ .RDM Folder
 - ▶ .RDC Folder
 - ▶ .R3D
 - ▶ .mxf (audio file, marked with an “A”)
 - ▶ .mxf (video file, marked with a “V”)
 - ▶ .rtn (RED Thumbnail file)

NOTE: The camera creates multiple .mxf files, similar to how the camera creates multiple R3D files.

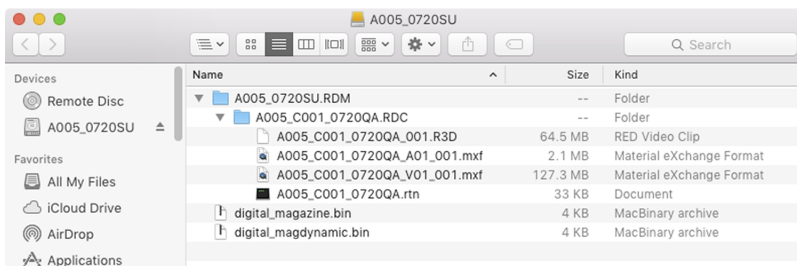

Figure: File Structure: R3D + DNxHD/HR

When recording Avid DNxHD/HR only, this is the file structure of the recorded files on the SSD (when the SSD is formatted as FAT32):

- ▶ .RDM Folder
 - ▶ .RDC Folder
 - ▶ .mxf (audio file, marked with an “A”)
 - ▶ .mxf (video file, marked with a “V”)
 - ▶ .rtn (RED Thumbnail file)

NOTE: The camera creates multiple files, similar to how the camera creates multiple R3D files.

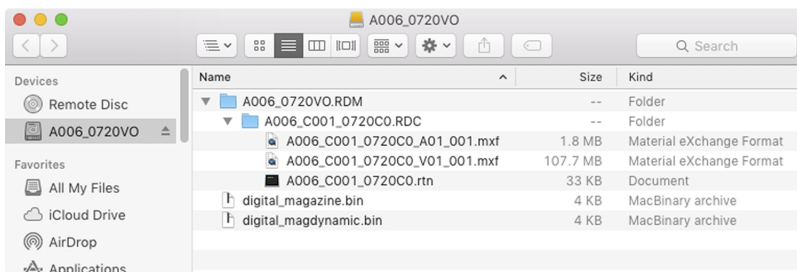

Figure: File Structure: R3D + DNxHD/HR

DSMC2 MONSTRO OPERATION GUIDE

SELECT RECORD FILE FORMAT

NOTE: For more information on which codecs your camera offers, go to ["Technical Specifications" on page 207](#).

To select what file formats to record to, follow the instructions below.

1. Go to **Menu > Settings > Recording > Codec**.
2. Select the file format(s) you want to record to from the **Record File Format** drop-down menu:
 - ▶ R3D
 - ▶ R3D + Apple ProRes
 - ▶ R3D + Avid DNxHD/HR
 - ▶ Apple ProRes
 - ▶ Avid DNxHD/HR

The selected file format displays in the Lower Status Row.

3. **R3D:** Select a target REDCODE compression ratio from the **REDCODE** menu. For more information, go to ["REDCODE" on page 61](#).
4. **Apple ProRes or Avid DNxHD/HR:** Select a resolution from the **Resolution** drop-down menu.
5. **Apple ProRes or Avid DNxHD/HR:** Select a codec from the **Record Video Codec** drop-down menu.
6. **Apple ProRes or Avid DNxHD/HR:** If the camera is in IPP2 mode, select an option from the **Baked-in Settings** drop-down menu. This determines which image settings are irreversibly encoded (baked) as image data in the recorded file. For more information on the options in this menu, go to ["Baked-In Settings" below](#).

NOTE: Although the "All Image Settings" is an option when 4K is selected within the Resolution drop-down menu, this option can only be applied with 2K output. If 4K and "All Image Settings" are selected at the same time, the Baked-in Settings turns red and yellow as a warning, and the settings are NOT applied.

BAKED-IN SETTINGS

If the camera is in IPP2 mode and you are recording to a 2K Apple ProRes or 2K Avid DNxHD/HR codec, you can irreversibly encode (bake) certain image settings into the recorded file. To bake in settings, select one of the following options from the **Baked-in Settings** drop-down menu:

- ▶ **Primary Only:** Only bakes the ISO, Color Temperature, Tint, and Exposure Adjust settings into the recorded file. Does NOT bake in the 3D LUT and other image settings.
- ▶ **All Image Settings:** Bakes all image settings into the recorded file, including the Primary Raw Development, Grading, and Output Transform stages. This includes the 3D LUT, CDLs, and output color space. For more information on the different IPP2 stages, see the [IPP2: Image Pipeline Stages](#) white paper at www.red.com/downloads. With the All Image Settings option, you can select either SDR or HDR to control the tone curve for standard dynamic range (SDR) or high dynamic range (HDR) output.

DSMC2 MONSTRO OPERATION GUIDE

FRAME PROCESSING

NOTE: Frame processing is not supported in Speed Ramp Mode. For more information, go to "[Speed Ramp Mode](#)" on page 125.

NOTE: For cameras with the MONSTRO sensor, frame processing is disabled for formats larger than 7680 x 4320.

Frame processing allows for the combination of multiple captured frames into one recorded frame. The combination occurs before the resulting frame is encoded. You can select the following frame processing settings: No Frame Processing, Frame Summing, Frame Averaging.

When in Frame Summing mode or Frame Averaging mode, the current integration time is applied to each frame. This means if the integration time is not the entire frame time (or 360°) there are gaps between the images used to create the combined frame. This may lead to unexpected motion artifacts.

The effect of frame processing is only visible during record. In Frame Summing mode, this means the exposure changes between preview and record. Experiment with the exposure and frame processing settings to achieve the effect you want.

NO FRAME PROCESSING

Normal frame processing mode. The Frames to Process selection does not affect recording.

FRAME SUMMING

Frame Summing combines the specified number of frames into one frame, and adds together the exposure time for each of the original frames. The resulting frame has an effective integration time that is equal to the current integration time multiplied by the number of frames.

For example, if you select 16 as the Frames to Process value, and set exposure to 1/48 sec, the resulting image has an effective integration time of 1/3 sec (16 x 1/48).

Frame summing results in a final image that is brighter and possibly blurrier than any of the original frames, so you can use frame summing to achieve the effect of long-exposure.

FRAME AVERAGING

Frame Averaging combines the specified number of frames into one frame, and averages the exposure time for each of the original frames. The resulting frame has an effective integration time that is equal to the current integration time.

For example, if you select 2 as the Frames to Process value, and set exposure to 1/48 sec, the resulting image still has the exposure value of 1/48 sec, along with the effect of long-exposure.

You can use frame averaging to achieve the effect of long-exposure along with the benefits of reduced noise. However, frame averaging does affect motion blur characteristics.

NOTE: For RED cameras with 8K sensors, a maximum of 2 frames can be averaged.

DSMC2 MONSTRO OPERATION GUIDE

PRE-RECORD

To set up Pre-Record, go to **Menu > Settings > Recording > Pre-Record**.

When enabled, the Pre-Record setting continuously captures a cache of footage before recording starts. Select to have 4 to 30 seconds (incremented at two second intervals) of pre-record time added to the actual footage. When Pre-Record is enabled, you will not miss the start of a shot by being a little slow on the trigger.

- ▶ **Pre-Record Duration:** Select the pre-record time.
- ▶ **Always trigger Pre-Record before recording:** When selected, Pre-Record always starts when recording starts:
 - ▶ Press **PWR/REC** to activate Pre-Record.
 - ▶ Press **PWR/REC** a second time to start recording.
 - ▶ Press **PWR/REC** a third time to stop recording.
- ▶ **Trigger Pre-Record Now:** When selected, the Pre-Record menu closes and Pre-Record mode starts.

NOTE: Always perform a Secure Format before using Pre-Record. A Secure Format restores the SSD back to factory out-of-box settings, and optimizes the SSD for Pre-Record.

NOTE: Pre-Record puts your SSD in a state of constant record. As with any SSD technology, continuously writing data over an extended period of time will impact the lifespan of the media.

NOTE: Audio is not recorded when Pre-Record is enabled.

NOTE: To use Pre-Record only for specific situations, map Pre-Record to a key (**Menu > Settings > Setup > Keys > Record: Start Pre-Record**). For more information, go to ["Keys" on page 142](#).

INDICATOR

- ▶ **Enable Sounds:** Select this check box to enable sounds. Then select sounds for the following actions:
 - ▶ Record Start
 - ▶ Record Stop
 - ▶ Tag Still Frame
- ▶ **EVF Tally Light:** Enable the EVF Record Tally LED on the EVF to illuminate red when recording.
- ▶ **SSD Tally Light:** Enable the Record Tally LED on the media bay to illuminate red when recording.

DSMC2 MONSTRO OPERATION GUIDE

HDRX MENU

NOTE: HDRX mode cannot be modified when test signals are enabled.

NOTE: You cannot change the exposure when HDRX is enabled.

In HDRx mode, the camera records two (2) exposures within the interval that it would usually record only one (1). The primary exposure is normal, and uses the standard aperture and shutter settings (the “A track”). The secondary exposure is typically for highlight protection, and uses an adjustable shutter speed that is 2 to 6 stops faster (the “X track”). Since the camera captures twice the usual amount of frames, the maximum available recording frame rate is halved and the REDCODE compression options are limited.

For more information, see the [High Dynamic Range Video with HDRX](http://www.red.com/learn/red-101/hdrx-high-dynamic-range-video) article, available at www.red.com/learn/red-101/hdrx-high-dynamic-range-video.

HDRX RESTRICTIONS

You cannot use HDRX mode when:

- ▶ The MOTION MOUNT Shutter Type is set to Soft or Square.
- ▶ A Sensor Sync Mode (Genlock or MoCo) is enabled.
- ▶ Speed Ramp mode is enabled.
- ▶ A Frame Processing mode (Frame Summing or Frame Averaging) is enabled.
- ▶ Network Storage mode is enabled.

ENABLE HDRX

By default HDRX is disabled, and the HDRX indicator in the Lower Status Row is grey.

To enable HDRX, follow the instructions below:

1. Go to **Menu > Settings > HDRX**.
2. Select **HDRX**.
The HDRX text in the Lower Status Row turns white.
3. Select the number of **Factors**. The range is 1 to 6, and the default is 2.
4. Select which track you want the display to show:
 - ▶ **A Track**: This track shows the video with the selected aperture and exposure settings applied.
 - ▶ **X Track**: This track shows the video with the additional stops applied.

DSMC2 MONSTRO OPERATION GUIDE

FOCUS MENU

To access the Focus menu, go to **Menu > Settings > Focus**.

The Focus menu includes: Mode and Rack.

MODE TAB

Use the Mode tab to select a focus setting. To set up focus, follow the instructions below:

1. Go to **Menu > Settings > Focus > Mode**.
2. Select a mode from the **Mode** drop-down menu. For more information, go to ["Mode" below](#).
3. Select a zone/target from the **Zone** drop-down menu. For more information, go to ["Zone/Target" below](#).
4. If using Spot, select a size from the **Size** drop-down menu. For more information, go to ["Size" below](#).
5. Select a confirm style from the **Confirm** menu. For more information, go to ["Confirm Style" below](#).

MODE

Select an option from the **Mode** drop-down menu:

- ▶ **Manual:** Enables manual focus. Disables all other settings in the Focus menu.
- ▶ **Confirm:** Enables a focus target, which changes color to indicate if the subject in the target is in focus. After selecting Confirm, set up the target type (zone), size, and confirm style. Inadequate lighting and/or contrast may decrease the performance of Confirm mode.
- ▶ **Single, Continuous, Touch Track, Rack:** For more information, go to ["Use Autofocus Modes" on the next page](#).

ZONE/TARGET

Select an option from the **Zone** drop-down menu:

- ▶ **Center:** A large square centered in the recording area.
- ▶ **Spot:** A small target for precise focus that you can move around the recording area. Select a size for the target from the **Size** drop-down menu. For information on how to move the Spot target, go to ["Move the Spot Focus Target" on the next page](#).

SIZE

Select a size for the Spot target from the **Size** drop-down menu.

CONFIRM STYLE

Select a confirm style from the **Confirm Style** drop-down menu.

STYLE	DESCRIPTION	OBJECT IN FOCUS	OBJECT OUT OF FOCUS
None	Square target	Target is yellow or green	Target is red
Circle	Yellow circle around a square target	Target is yellow or green; circle is almost the same size as the square	Target is red; circle gets bigger
Bar	Bar target	Target is yellow or green; vertical bar on the right side is filled up	Target is red; vertical bar on the left side is almost empty
Pie	Pie target	Target is yellow or green; line around the curve is filled up	Target is red; line around the curve is almost empty

DSMC2 MONSTRO OPERATION GUIDE

TARGET COLOR

Both the Center and Spot targets change color to indicate if the objects in the target are in focus.

- ▶ **Blue:** Camera is focusing
- ▶ **Red:** Objects are out of focus
- ▶ **Yellow:** Objects are almost in focus
- ▶ **Green:** Objects are in focus

MOVE THE SPOT FOCUS TARGET

Move the Spot target with a touchscreen:

- ▶ Tap and hold the touchscreen on the location where you want to relocate the Spot target.
- ▶ Tap and hold the touchscreen where the Spot target currently is, and drag the Spot target.

USE AUTOFOCUS MODES

When supported lens mounts and lenses are attached, autofocus modes display in the Mode drop-down menu. Although the camera supports autofocus, RED recommends using these autofocus modes only as focus assist tools. Performance may vary from lens to lens. For optimal focus accuracy, use manual focus.

AUTOFOCUS REQUIREMENTS

Autofocus modes are available (in the Mode drop-down menu) in any of the following situations:

- ▶ A DSMC S35 Nikon Mount and a supported lens is attached. The lens focus switch is set to “A” or “M/A”.
- ▶ A DSMC Canon Mount and a supported lens is attached. The lens focus switch is set to “AF”.
- ▶ A DSMC RED MOTION MOUNT S35 Ti Canon (Captive) lens mount and a supported lens is attached. The lens focus switch is set to “AF”.

AUTOFOCUS MODES

- ▶ **Single:** When you press the key mapped to AF: Start, the camera performs single-shot AF. Optimized for rapid focus even in low-contrast conditions. Works with Center and Spot zones.
- ▶ **Continuous:** When you press the key mapped to AF: Start, the camera attempts to keep objects in the target in focus. Works best with good lighting and contrast. Works with Center and Spot zones.
- ▶ **Touch Track:** Dynamically updates a positionable AF point using the touchscreen. Works with Spot zone. Keep the target on the subject while moving it across frame, since the lens continuously focuses on that target.
- ▶ **Rack:** Enables rack focus. Works with Spot zone. For more information, go to ["Rack Focus" on the next page.](#)

NOTE: Press the key mapped to AF Mode: Cycle to cycle through the autofocus modes.

DSMC2 MONSTRO OPERATION GUIDE

AUTOFOCUS PERFORMANCE

Autofocus performance may be reduced in the following conditions:

- ▶ Subject is too dark or distant.
- ▶ Subject is too bright or close.
- ▶ Inadequate contrast between the subject and background.
- ▶ Inadequate surface contrast or detail.
- ▶ Scene has reflective highlights.
- ▶ Subject is backlit.

NOTE: Use Edge mode for assistance in these conditions. For more information, go to ["False Color Modes: Edge" on page 94](#).

RACK FOCUS

Use the Rack tab to set up rack focus.

SET UP RACK FOCUS

1. Ensure that a DSMC Nikon Mount, DSMC Canon Mount, or DSMC RED MOTION MOUNT S35 Ti Canon (Captive) lens mount and a supported lens are attached to the camera.
 2. Go to **Menu > Settings > Focus > Mode**.
 3. Select **Rack** from the **Mode** drop-down menu.
 4. Select a size from the **Size** drop-down menu.
 5. Go to the **Rack** tab.
 6. Use the **Rack Speed** slider to change the speed at which the lens moves. Move the slider to the left for a slower speed, and to the right for a faster speed.
 7. Enable up to four (4) **Rack Points**.
 8. To set a rack point location, follow the instructions below:
 - A. Select the rack point: **A, B, C, or D**.
 - B. Select **Close**.
 - C. Press and hold the touchscreen where you want the rack point to be, or press and drag the rack point. When you move a rack point, the camera autofocuses.
- NOTE:** To prevent a rack point from being accidentally moved, the rack point is less sensitive to touch than other focus targets.
- NOTE:** To view the focus distance for each rack point on the main screen, enable **Rack Show Distance** mode. For more information, go to ["Lens" on page 152](#).
9. Select another rack point by performing any of the following actions:
 - ▶ Select another rack point on the touchscreen.
 - ▶ Press the key mapped to **AF: Start** to cycle to the next rack point in order (A, B, C, and D). For example, if rack point A is selected when you trigger the AF: Start action, the focus racks from point A to point B.
 - ▶ Press a key that is mapped to racking to a specific rack point.

MAP KEYS FOR RACK FOCUS

The camera offers multiple rack focus actions that you can map to user keys. In the Key menu, searching for "rack" shows all rack focus actions. For more information, go to ["Keys" on page 142](#).

DSMC2 MONSTRO OPERATION GUIDE

EXPOSURE ASSIST MENU

To access the Exposure Assist menu, go to **Menu > Settings > Exposure Assist**.

The Exposure Assist menu provides access to settings for the Auto Exposure (AE) feature. The AE feature maintains a constant image brightness, even if the actual scene brightness changes.

The AE feature is different than traditional AE, in that RED AE only controls the amount of light that hits the sensor, either by adjusting aperture or exposure. RED AE analyzes RAW data before the ISO curve, and ensures that the sensor matches the user-selected brightness.

AUTO EXPOSURE MODES

The Exposure Assist modes determine when the AE tools go into effect:

- ▶ **Off:** The AE tools are not enabled.
- ▶ **Single Shot:** Map one of the following actions to trigger the AE tools:
 - ▶ AE: Start
 - ▶ AE/AF: Start
- ▶ **Continuous in Preview:** The AE tools are enabled in preview only.
- ▶ **Continuous in Preview/Record:** The AE tools are enabled in both preview and record.

NOTE: In Stills mode, AE/AF: Start is mapped to Record Half Press by default. For more information, go to "[Default Key Functions](#)" on page 263.

EXPOSURE PRIORITY

- ▶ **Manual:** You have full control of aperture and shutter. (Default)
- ▶ **Auto:** The camera sets the aperture and shutter to meet the selected exposure.
- ▶ **Av (Aperture Value):** You set the aperture, and then the camera sets the shutter to meet the selected exposure.
- ▶ **Tv (Time Value):** You set the shutter, and then the camera sets the aperture to meet the selected exposure.

EXP COMP AND EV SHIFT

Use the **Exp Comp** (Exposure Compensation) slider and the **EV Shift** setting to adjust the brightness of the image. The default setting of zero (0) attempts to match the average brightness on an 18% grey-target. When AE is enabled, the target and current measured brightness for the selected metering area display in the histogram as a grey and white line, respectively.

You can also map these actions to user keys:

- ▶ **AE: Decrease EV Offset:** Reduces the EV Offset in increments of 0.2.
- ▶ **AE: Increase EV Offset:** Increases the EV Offset in increments of 0.2.

METERING MODE

Metering determines the area of the sensor that is used for brightness evaluation:

- ▶ **Spot:** Weights the measurement to the center 5% of the sensor, approximately.
- ▶ **Center:** Weights the measurement to the center 25% of the sensor, approximately.
- ▶ **Average:** Averages the entire image area of the sensor.

DSMC2 MONSTRO OPERATION GUIDE

SPEED

The Speed setting determines how quickly the algorithm adapts to changing light.

- ▶ **Slow:** Settings adapt in small steps. Use this setting for fewer and gradual adjustments.
- ▶ **Normal:** Settings adapt in medium steps.
- ▶ **Fast:** Settings adapt in large steps.

SELECTION

The Selection setting determines which values the algorithm uses. This enables you to modify the list of values so that the algorithm selects only specific parameters. Use **Free Value Selection** to improve accuracy.

For example, you can modify the aperture list to include f/2.8 and f/5.6. If Free Value Selection is enabled, the algorithm only selects aperture parameters between f/2.8 and f/5.6. This setting limits the range of focal depth.

AE INDICATORS

When the AE feature is able to match the sensor brightness, the overlay turns yellow. If the brightness fluctuates more than half of a stop, the overlay turns red.

When AE is enabled, the “AE” indicator displays before the aperture and exposure parameters in the Upper Status Row. The user-selected brightness and current measured brightness display in the histogram as grey and white lines, respectively.

AE LIMITS

All limits, includes custom modifications made to available menu items, are taken into account when AE is active. For example, if you modify the available list of exposure values, only those values are considered.

DSMC2 MONSTRO OPERATION GUIDE

SETUP

The Setup menu includes: Keys, Date/Time, Communication, GPIO/Sync, Fan Control, Lens, and Motor Control.

KEYS

Map keys to often-used actions to easily control the camera. For a full list of the default key mappings, go to "[Default Key Functions](#)" on page 263.

NOTE: If using a third-party module, the default GPI functions may match the inputs offered by the module (instead of the RED defaults).

KEY MAPPING

To map or remap a user key:

1. Press the user key that you want to map.
2. Select an action from the **Press** (or **CCW**) drop-down menu that you want to map to the user key.
3. To un-map a key, select **-Key Disabled-** from the drop-down menu.
4. If you want, map a **Release** or (**CW**) action to the key.
A Release action occurs when a pressed key is released.

OPTIONS

- ▶ **Lock Side Module keys:** None of the module keys perform any actions when pressed, unless you set up the exceptions below:
 - ▶ Record key remains active when locked
 - ▶ Navigation keys remain active when locked
- ▶ **Show key action notifications:** A notification displays on the bottom of the display when you perform an action mapped to a key.
- ▶ **Enable Side Handle focus control:** Enables the Focus Control Wheel on the DSMC2 Side Handle. For more information, go to "[DSMC2 Side Handle](#)" on page 77.

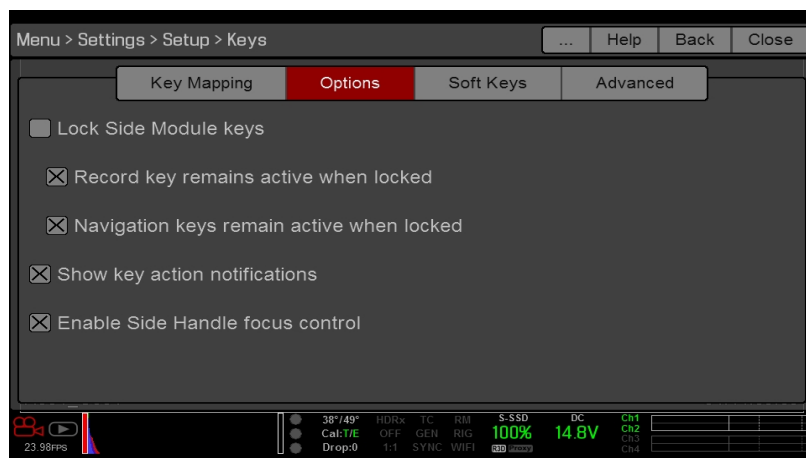

Figure: Key Options

DSMC2 MONSTRO OPERATION GUIDE

SOFT KEYS

The following sets of soft keys are available on the touchscreen:

- ▶ **A, B, C, D:** Left side of the touchscreen
- ▶ **1, 2, 3, 4:** Right side of the touchscreen

To map or remap a soft key, select an action from the drop-down menu next to the key you want to map.

- ▶ **Enable Soft Keys on touchscreen:** Tap the left or right side of the touchscreen to show the soft keys.
- ▶ **Show key actions as labels:** When the soft keys display, the number/letter of the key and the key action display.

ADVANCED

Use the Advanced tab to map any key, even if the key is not currently accessible.

WARNING: It is possible to remap the navigation keys using this tab. However, if you do not have a touchscreen attached, it is possible to lock out control. Be careful when remapping navigation keys.

DATE/TIME

Use the Date/Time menu to reset the internal clock of the camera. The time and date are timestamps on R3D[®] files when recording to an SSD. The camera uses the 24-hour clock convention (military time). For example, enter 2:35 p.m. as 14:35:00.

The date and time are saved when you close the Date/Time menu.

COMMUNICATION

Use the Communication menu to allow one (1) or more cameras to communicate with each other or external devices.

You can use the serial port or a direct Ethernet cable to connect two (2) cameras, or one (1) camera and one (1) external device. If the camera is connected via Ethernet to a hub or router, multiple cameras and devices can communicate with each other.

For example, on a multi-rig 3D shoot, you can send commands to an individual camera (Example: Set CAM_A_L to 1/48 exposure), to a group of cameras (Example: Set 3DRIG_A to 48 fps), or to all cameras (Example: Start Recording on all cameras).

CAMERA

To access the Camera menu, go to **Menu > Settings > Setup > Communication**.

Use the Camera menu to set up a unique identifier for your camera (or a group of cameras). All command filtering happens on the receiver side of the communication link. Use camera names and group names to address commands to a specific camera or group of networked cameras.

- ▶ **Camera ID:** Enter a unique camera name to use in network communications. The field is limited to eight (8) characters.
- ▶ **Group ID:** Enter a group name to identify the camera as a member of a group of devices. The field is limited to eight (8) characters, and the default name is DEFAULT.
- ▶ **Target:** Specify which devices the camera can send commands to:
 - ▶ **All:** The camera can send commands to all devices on the network.
 - ▶ **None:** The camera can only receive commands. The camera cannot send commands.
 - ▶ **Custom:** The camera can send commands to a specific camera/device (enter the name of the camera/device in the Target ID text box) or a specific group (enter the name of the group in the Target ID text box). The camera/group name must match the name entered in the Camera/Group field of the target device(s).

DSMC2 MONSTRO OPERATION GUIDE

SERIAL

NOTE: CTRL and GIG-E ports are only available on specific DSMC2 expanders and modules. For more information, go to ["Input/Output Connectors" on page 218](#).

To access the Serial menu, go to **Menu > Settings > Setup > Communication > Serial**.

The camera can communicate to external devices via the CTRL and the GIG-E connectors (camera-to-camera communication is possible only via GIG-E).

Select one of the following protocols from the **Serial Protocol** drop-down menu:

- ▶ None (Default)
- ▶ Element Technica
- ▶ 3ality SPC 7XXX
- ▶ RED Command Protocol

ETHERNET

NOTE: Using Ethernet requires a GIG-E port, which is available on the DSMC2 Jetpack-SDI Expander, DSMC2 REDVOLT Expander, and DSMC2 Production Module. For more information, go to ["Input/Output Connectors" on page 218](#).

To set up the Ethernet settings, go to **Menu > Settings > Setup > Communication > Ethernet**.

Each camera or device requires a unique IP address. For camera-to-camera communication via Ethernet, both cameras need to be in the same sub-net (have the same netmask address) and have the same gateway address.

- ▶ **Enable DHCP:** Enables DHCP. If a DHCP-server is available in the communications network, the camera obtains an IP address, netmask address, and gateway address automatically from the DHCP server. You cannot manually enter anything in the IP Address, Netmask, and Gateway fields when this check box is selected.
- ▶ **Enable Camera to Camera:** A change to settings on this camera is sent to other cameras via the network as a SET command (as UDP packets). The SET command then sets the property on other cameras. If this camera receives a SET command, the camera does not send the command to other cameras/devices.
- ▶ **Enable External Control:** This camera can be controlled via TCP/IP from an external device.

DSMC2 MONSTRO OPERATION GUIDE

WIRELESS CONNECTION

The camera offers a wireless (802.11g) connection that provides communication support for third-party applications. The camera uses the RED Command Protocol (R.C.P.) to communicate information between the camera and an application. As with all wireless devices, the communication range may be affected by the environment and any radio frequency (RF) interference that may be present. The wireless frequency is 2.4 GHz. For optimal performance, do not obstruct the antenna with any accessory, mounting plate, or mounting rail.

There are two (2) ways to connect the camera to a device:

- ▶ **Ad-Hoc mode:** The camera and your device connect to each other.
- ▶ **Infrastructure mode:** The camera and your device both connect to an access point, and communicate through that wireless network.

NOTE: To connect the camera to an app, the app must have been programmed using the R.C.P. SDK, which is available through the R.C.P. Development Kit.

NOTE: The wireless antenna is integrated into the fan grill (top side of camera).



Figure: Do Not Obstruct WiFi Antenna

DSMC2 MONSTRO OPERATION GUIDE

CONNECT WIRELESSLY TO A DEVICE VIA AD-HOC MODE

In Ad-Hoc mode, the camera and your device connect to each other. To connect the camera to your device via an ad-hoc network, follow the instructions below:

1. Go to **Menu > Settings > Setup > Communication**.
2. Select the **WiFi** tab.
3. Select **Ad-Hoc** from the **Mode** drop-down menu.
4. Select a wireless channel from the **Channel** drop-down menu. The default is Ch1, and you can select one out of 11 channels.
5. Select a security option from the **Encryption** drop-down menu:
 - ▶ **NONE**: The connection will be unsecured.
 - ▶ **WPA2**: The connection will be encrypted via WPA2.
6. If you selected WPA2 as the encryption option, type the passphrase that will be required to access the network.
7. Close the WiFi screen.
8. Connect your device to the ad-hoc network created by the camera. The steps in this procedure depend on what type of device and operating system you are using. For example, if you are connecting an iOS device, go to **Settings > Wi-Fi > Devices**, and select the camera name.

The camera name displays on the WiFi screen in-camera. The camera and your device are now connected.

NOTE: If you created a passphrase for the network, you will need to enter that passphrase.

CONNECT WIRELESSLY TO A DEVICE VIA INFRASTRUCTURE MODE

In Infrastructure mode, the camera and your device both connect to an access point, and communicate through that wireless network. The camera can connect to access points that are not encrypted, use WPA encryption, or use WPA2 encryption. To connect the camera to your device via an existing wireless network, follow the instructions below:

1. Connect your device to a wireless network. The access point for the network must have DHCP enabled.
2. Make sure that you know the name and password for the network, since you will need that information to connect the camera to the same network.
3. Go to **Menu > Settings > Setup > Communication**.
4. Select the **WiFi** tab.
5. Select **Infrastructure** from the **Mode** drop-down menu.

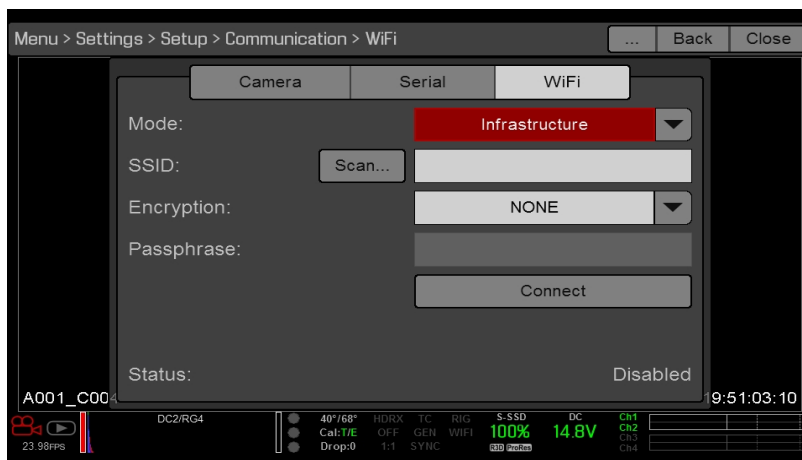

Figure: WiFi Menu

DSMC2 MONSTRO OPERATION GUIDE

6. Select **Scan** to search for available wireless networks.
The available wireless networks (access points) display.
7. Highlight the wireless network that your device is connected to and select **Select**.

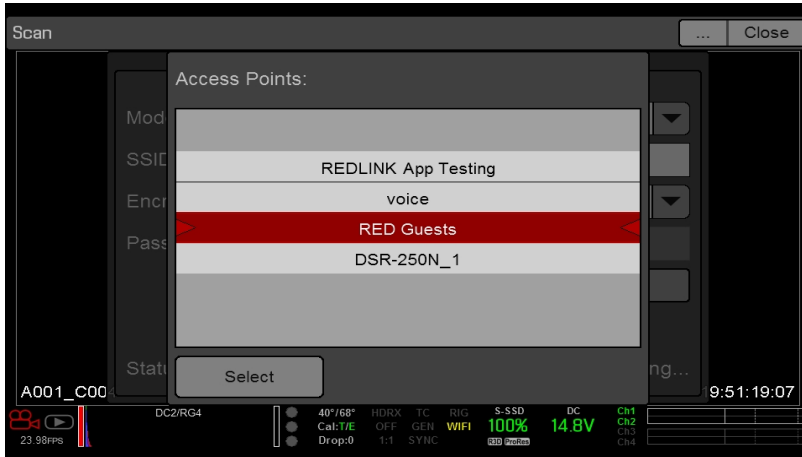

Figure: Select Wireless Network

8. If you select an encrypted network, follow the instructions below to enter the passphrase for the network:
 - A. Select a security option from the **Encryption** drop-down menu.
 - B. Tap or select the **Passphrase** text box.
 - C. Type the passphrase to access the network.
 - D. Select **OK**.
9. To enable/disable DHCP, select **IP Config** and set up the IP settings. For more information on configuring DHCP and IP settings, go to "[Ethernet](#)" on page 144.
10. Select **Connect** at the bottom of the WiFi screen.
The IP address of the access point displays at the bottom of the WiFi screen after the camera connects to the access point.

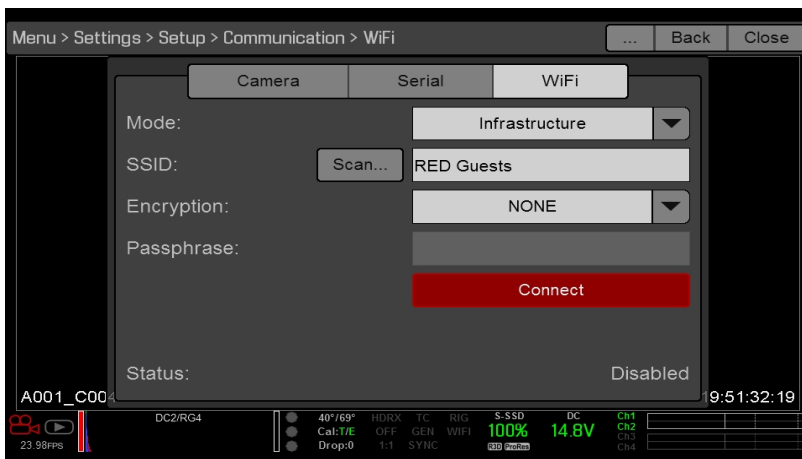

Figure: Select Connect

DSMC2 MONSTRO OPERATION GUIDE

11. Connect your device to the same wireless network that the camera is connected to. The steps in this procedure depend on what type of device and operating system you are using. For example, if you are connecting an iOS device, go to **Settings > Wi-Fi**, and select the wireless network.

The camera and your device are now connected.



Figure: Connect to Network

12. To ensure that your app can communicate with the camera, ensure that there is a way to connect your app to a specific camera. Since there may be multiple cameras in the area, select your specific camera in the app itself.

DSMC2 MONSTRO OPERATION GUIDE

GPIO SYNC

NOTE: Using general purpose inputs/outputs and sync requires an expander or module. For more information, go to ["Input/Output Connectors" on page 218](#).

SYNC

Use the Sync menu to set up genlock and Motion Control (MoCo). For more information, go to ["Timecode, Genlock, Multi-Camera Setup" on page 172](#).

NOTE: Using sync and genlock requires an expander or module. For more information, go to ["Input/Output Connectors" on page 218](#).

SENSOR SYNC MODE

Sensor Sync Mode allows the shutter timing (scan start) to sync to an external signal.

- ▶ **Off:** Sensor runs at the current recording frame rate. This is the default option.
- ▶ **Genlock:** Sensor synchronizes with the incoming compatible genlock signal.
- ▶ **MoCo:** Each rising edge on the sync input triggers a frame to be captured.

GENLOCK SOURCE

Select a genlock input:

- ▶ BRAIN (Default)
- ▶ Rear Module

BRAIN GPIO

NOTE: Using general purpose inputs/outputs and sync requires an expander or module. For more information, go to ["Input/Output Connectors" on page 218](#).

- ▶ **GPI Function (Camera Input):** Select one (1) of the following options to configure the input for devices connected to the SYNC connector on the camera:
 - ▶ **Sync In:** The camera input is used as a sync-in signal for MoCo.
 - ▶ **General Purpose In:** Use the BRAIN GPI In High/Low drop-down menus to map inputs to actions.
- ▶ **GPO Function (Camera Output):** Select an option to configure the output for devices connected to the CTRL connector on the camera:
 - ▶ **Sync Out:** Provides an output sync signal to act as a shutter start tally.
 - ▶ **Recording Indicator Out:** Provides a signal when recording is in process.

GEN AND SYNC STATUS INDICATORS

The Lower Status Row of the camera display has GEN and SYNC indicators, which change color based on the current genlock and sync statuses. For more information, go to ["Project Status Indicators" on page 67](#).

DSMC2 MONSTRO OPERATION GUIDE

FAN AND TEMPERATURE MANAGEMENT

To select a fan control mode, go to **Menu > Settings > Setup > Fan Control**.

The camera is controlled by complex thermal algorithms to ensure that the sensor and camera operate at safe temperatures. Each fan control mode affects the sensor temperature, sensor warm-up time, fan speed, and resulting fan noise.

When selecting a fan mode, first take into consideration how each fan mode behaves, and then select a fan mode that fits the needs of your project.

Regardless of sensor type and fan mode, you will get the best image quality by calibrating the sensor at the temperature that you want to use for your shoot.

FAN CONTROL MODES

Select a fan control mode.

NOTE: After selecting a new fan setting, run the camera until the core temperature stabilizes, and then calibrate the sensor.

NOTE: Manual mode requires that you actively manage the sensor temperature, because this mode focuses on controlling fan speed and does not target a narrow sensor temperature range. Use the T/E status indicators as guides for proper temperature calibration.

NOTE: Maximum speeds are intended as target speeds only; actual fan speeds may be higher at times due to long recording times or high ambient temperatures.

ADAPTIVE (TARGET TEMPERATURE)

Adaptive is the default mode for the camera.

Select a Target Temperature and the fans self-adjust to maintain the selected temperature. The default Target Temperature is 39°C. After the camera reaches the Target Temperature, and if the ambient temperature remains constant, Adaptive mode results in a consistent fan speed and fan noise over time.

Targeting a higher temperature raises the sensor temperature, lengthens the sensor warm-up time, and lowers the fan speed. Targeting a lower temperature lowers the sensor temperature, shortens the sensor warm-up time, and increases the fan speed.

NOTE: The intent of Target Temperature is to set the sensor temperature so that you can then create a calibration map for that temperature.

NOTE: When the camera turns on, the Target Temperature is the temperature of the current calibration map, regardless of what the Target Temperature was before you turned off the camera. Setting a calibration map also overrides the Target Temperature. For more information, go to "[Sensor Calibration](#)" on page 159.

ADAPTIVE PREVIEW QUIET RECORD

- ▶ **Record mode:** The camera uses Quiet fan mode. For more information, go to "[Quiet](#)" below.
- ▶ **Standby mode:** The camera uses Adaptive fan mode. For more information, go to "[Adaptive \(Target Temperature\)](#)" above.

QUIET

The fans self-adjust to maintain the lowest possible noise level in record and standby mode while still cooling the camera.

DSMC2 MONSTRO OPERATION GUIDE

MANUAL

Select a speed for the fans in both record and standby modes. The fans self-adjust to maintain the selected speeds. The default Maximum Record Speed is 50% and the default Maximum Preview Speed is 75%. The range for both Maximum Record Speed and Maximum Preview Speed is 20–100%.

POST RECORD DELAY

Select the amount of time that it takes for the fan to switch from record to preview mode.

DSMC2 MONSTRO OPERATION GUIDE

LENS

To access the Lens menu, go to **Menu > Settings > Setup > Lens**.

LENS TAB

The options displayed on the Lens tab change based on the attached lens mount.

PL MOUNT

- ▶ **Enable Power to Lens:** Ensures that the camera powers the lens via the lens mount. This feature is enabled by default, but the camera saves the last selected setting. Deselect when using a Fujinon® T2.9 Cabrio Premier PL lens. If you disable this feature for the Fujinon Cabrio, re-enable it when using other lenses. For more information, go to "[Fujinon T2.9 Cabrio Premier PL Lenses](#)" on page 252.
- ▶ **Auto-Detect PL Lenses:** By default, this feature is enabled.
- ▶ **Detect Lens:** Detects a lens, if one is attached.

CANON AND NIKON LENS SETTINGS

The options below display when a DSMC Nikon Mount or DSMC Canon Mount is installed with a supported lens.

- ▶ **Aperture:** Enter the aperture value. The range and default depend on the lens.
- ▶ **Focus:** Use the slider to change the focal distance. Manually changing the focal distance on the lens itself does not cause the slider to move. This setting is only available if the lens is in AF mode.
- ▶ **Init Lens:** Initializes the lens.

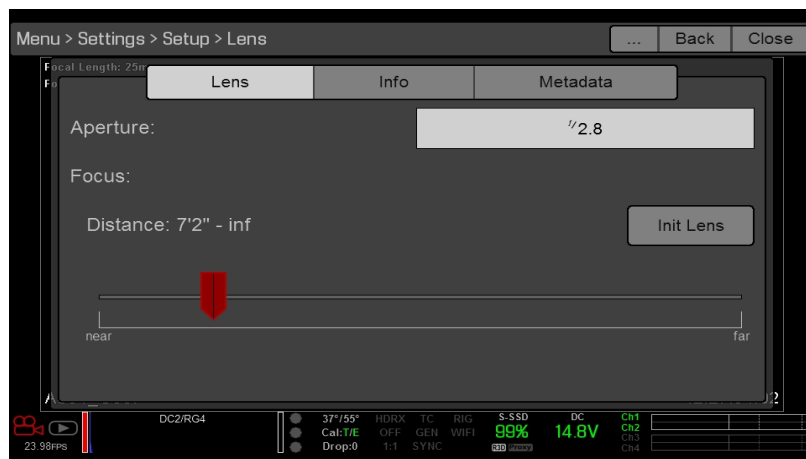

Figure: Lens Menu

DSMC2 MONSTRO OPERATION GUIDE

LENS INFO TAB

The Info tab displays the attached lens mount and lens information.

LENS METADATA TAB

If a supported lens is attached, the camera autopopulates some Lens Metadata fields. You can also manually edit the Lens Metadata fields to describe the attached lens. The information is stored in the clip metadata. The Lens Metadata fields are:

- ▶ Lens Name
- ▶ Lens Serial Number
- ▶ Lens Owner
- ▶ Lens Manufacturer
- ▶ Lens Min Focal Length
- ▶ Lens Max Focal Length

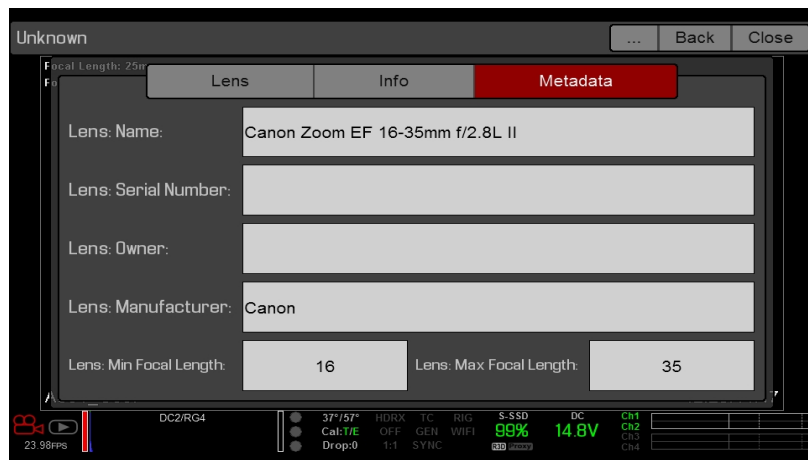

Figure: Metadata

MOTION MOUNT TAB

The Motion Mount menu is only accessible when a DSMC RED MOTION MOUNT S35 lens mount is installed. For more information, see the [RED MOTION MOUNT Operation Guide](http://www.red.com/downloads), available at www.red.com/downloads.

MOTOR CONTROL

To access the Motor Control menu, go to **Menu > Settings > Setup > Motor Control**.

This menu is only accessible when the RED 3-Axis Lens Control System is attached. Use the Motor Control menu to set up the RED 3-Axis Lens Control System. For more information, see the [RED 3-Axis Lens Control System Operation Guide](http://www.red.com/downloads), available at www.red.com/downloads.

DSMC2 MONSTRO OPERATION GUIDE

MAINTENANCE

The Maintenance menu includes: Save Log, Upgrade, Calibrate, Self-Test, Restore System, Rediscover, System Status, and OLPF.

SAVE A LOG FILE

A log file is a detailed text file of the processes and operations performed by the camera. If you contact RED for support, you may be asked to send a log file.

To save a log file, follow the instructions below:

1. Ensure that an SSD is properly mounted to the camera.
2. Go to **Menu > Settings > Maintenance**.
3. Select **Save Log**.

The log file is saved as a *.txt file in the SSD root directory.

For more information about RED support or to create a support ticket, go to <https://support.red.com>.

NOTE: The camera automatically saves a log file when it is turned off properly and an SSD is mounted.

UPGRADE

To access the Upgrade menu, go to **Menu > Settings > Maintenance > Upgrade**.

You can check for upgrades for the following items:

- ▶ **Camera:** Go to "[Upgrade Camera Firmware](#)" on page 187.
- ▶ **Media:** For more information on the media upgrade procedure, see the [DSMC Media Operation Guide](#), available at www.red.com/downloads.

CALIBRATE

The Calibrate menu includes:

- ▶ **Sensor:** For more information, go to "[Sensor Calibration](#)" on page 159.
- ▶ **Gyro/Acc:** For more information, go to "[Gyroscope and Accelerometer Calibration](#)" below.

GYROSCOPE AND ACCELEROMETER CALIBRATION

The internal three-axis gyroscope and three-axis accelerometer need to be calibrated for the Horizon overlay to function properly. The Gyro/Acc calibration file is stored in the flash memory of the camera, so you DO NOT need to recalibrate after restoring the camera or upgrading firmware. For more information, go to "[Display Modes: Horizon](#)" on page 96.

To calibrate the Horizon overlay, follow the instructions below:

1. Turn on the camera and place it on a level surface.
2. Wait for the camera core temperature to reach room temperature.
3. Go to **Menu > Settings > Maintenance > Calibrate > Gyro/Acc** and select **Low Temperature Calibration**.
4. After the calibration finishes, wait for the camera core temperature to reach maximum operating temperature.
5. When the camera reaches maximum operating temperature, select **High Temperature Calibration**.

DSMC2 MONSTRO OPERATION GUIDE

SELF-TEST

The Self-Test menu includes: Enable/Disable Sensor Test Pattern and Touchscreen.

ENABLE/DISABLE SENSOR TEST PATTERN

The Sensor Test Pattern is used during manufacturing and stress testing. For more information, go to "[Perform a Stress Test](#)" on page 193. The Sensor Test Pattern is a white screen with vertical lines.

To enable/disable the sensor test pattern, go to **Menu > Settings > Maintenance > Self-Test > Enable/Disable Sensor Test Pattern**.

TOUCHSCREEN

To perform a touchscreen self-test, follow the instructions below:

1. Go to **Menu > Settings > Maintenance > Self-Test**.
2. Select **Touchscreen**.
A grid of green squares displays on the touchscreen.
3. Touch each box with your finger.
Each green box turns blue.
4. To exit the self-test, perform one (1) of the following actions:
 - ▶ Touch all of the boxes, so that they are all blue.
 - ▶ Press and hold the touchscreen.
 - ▶ Press the **Enter** or **Menu** button on the DSMC2 SIDEKICK.

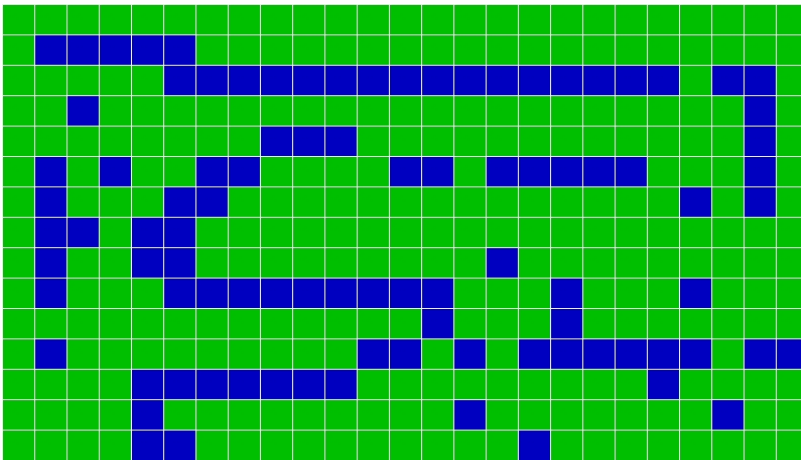

Figure: Self-Test Menu

DSMC2 MONSTRO OPERATION GUIDE

RESTORE SYSTEM

Restore System offers two (2) types of restores: Reset Defaults and Wipe Camera.

RESET DEFAULTS

Reset Defaults changes all settings to the factory default values. To perform a Reset Defaults, follow the instructions below:

1. Go to **Menu > Settings > Maintenance > Restore System**.
2. Select **Reset Defaults**.
3. Select **YES** on the screen that asks you to confirm the action.
The camera turns off.
4. Turn on the camera.

WIPE CAMERA

Wipe Camera deletes all user settings, including: looks, calibration files, overlays, and presets. Wipe Camera restores all factory defaults.

1. Go to **Menu > Settings > Maintenance > Restore System**.
2. Select **Wipe Camera**.
3. Select **YES** on the screen that asks you to confirm the action.
The camera turns off.
4. Turn on the camera.

REDISCOVER (HARDWARE REDISCOVER)

Rediscover all hardware and caches the data for future boot cycles. Perform a Hardware Rediscover if an attached device or lens mount is not functioning correctly.

To perform a Hardware Rediscover, follow the instructions below:

1. Go to **Menu > Settings > Maintenance**.
2. Select **Rediscover**.
3. Select **Yes** on the screen that asks you to confirm the Hardware Rediscover.
The camera turns off.
4. Turn on the camera.

SYSTEM STATUS

The System Status menu displays key project and system information.

PROJECT STATUS

Displays the current camera and project settings. Includes the following tabs: File Format, Recording, ProRes, DNxHD/HR, Image, Other.

ATTACHED MODULES

Lists the attached RED modules, lens mount, and expanders.

This screen does not list attached displays and lenses.

DSMC2 MONSTRO OPERATION GUIDE

RCP CONNECTIONS

Lists any RCP clients the camera is connected to.

CAMERA INFO

Displays the following camera information:

- ▶ **Type:** Camera type and sensor type.
- ▶ **Firmware Version:** Current firmware version.
- ▶ **PIN:** The personal identification number that is specific to your camera.
- ▶ **SVN Revision:** The current firmware number.
- ▶ **Runtime:** The number of hours that the camera has been turned on.
- ▶ **Name:** Sensor type.

OLPF

RED offers multiple optical low-pass filters (OLPFs). Each OLPF optimizes certain characteristics to take full advantage and control of each shooting environment. The camera checks the OLPF type, and adjusts the color science based on the selected OLPF.

To view your OLPF type, go to **Menu > Settings > Maintenance > OLPF**. The OLPF that is installed in your camera displays in the **OLPF Type** field.



Figure: OLPF Menu

DSMC2 MONSTRO OPERATION GUIDE

THIRD-PARTY OLPFs

WARNING: RED does not guarantee that third-party OLPFs will work as intended. Any damage caused by using a third-party OLPF, or any undesirable effects to the footage caused by using a third-party OLPF, is not covered under any RED warranty. If you have any questions or support issues with a third-party OLPF, contact the OLPF's manufacturer.

If you are using a third-party OLPF, follow the instructions below to set up the OLPF:

1. Install the OLPF. For more information, go to "[Swap an Interchangeable OLPF](#)" on page 53.
2. Go to **Menu > Settings > Maintenance > OLPF**.
3. Select an option from the **3rd Party Emulated Type** drop-down menu. This menu lists the RED OLPFs that are available for the camera. The camera will simulate the color science based on the RED OLPF that you select. RED DOES NOT guarantee that the third-party OLPF and the camera's color science will match.
4. Enter a name for the OLPF in the **3rd Party Name** field. The name that you enter is for metadata purposes; the name has no effect on the color science.

CHAPTER 6:

SENSOR CALIBRATION

Sensor calibration, also known as black shading, is a process during which the camera optimizes image quality by ensuring that pixel sensitivity remains consistent throughout the sensor. Calibrating the sensor generates a calibration map based on system and environment settings. After calibration, the sensor shows a uniform noise profile over the whole area without any falloffs on any side.

The camera offers two (2) ways to calibrate the sensor:

- ▶ **Manual Calibration:** RED recommends using Manual Calibration for the HELIUM 8K S35, MONSTRO 8K VV, and GEMINI 5K S35 sensors. For more information, go to "[Calibrate Sensor: Manual Calibration](#)" on the next page.
- ▶ **Auto Calibration:** RED recommends using Auto Calibration for the DRAGON 4.5K, DRAGON 5K, DRAGON 6K, and DRAGON-X 5K sensors. For more information, go to "[Calibrate Sensor: Auto Calibration](#)" on page 161.

For more information, see the [Sensor Calibration Methods](#) article.

NOTE: Calibration maps are still available after performing a system restore.

WHEN TO CALIBRATE SENSOR

Calibration is required:

- ▶ After an extreme change in temperature (+/- 30°F or +/-15°C) from the current calibration map.
- ▶ After an extreme change in exposure time (+/- 1/2 sec) from the current calibration map.
- ▶ If either the T or E in the CAL: T/E indicator is not green.
- ▶ After each firmware upgrade.

To check the temperature/exposure of the current calibration file, go to **Menu > Settings > Maintenance > System Status > Project Status**.

DSMC2 MONSTRO OPERATION GUIDE

CALIBRATE SENSOR: MANUAL CALIBRATION

The camera offers two (2) ways to calibrate the sensor: Manual Calibration and Auto Calibration. This section describes how to calibrate the sensor with Manual Calibration.

When you start a Manual Calibration, the camera calibrates the sensor at the current exposure and temperature setting. You will need to re-calibrate the sensor after extreme changes in exposure and temperature. The Manual Calibration process takes several minutes.

MANUAL CALIBRATION PROCEDURE

To perform a Manual Calibration, follow the instructions below:

1. Ensure that the camera reaches the temperature that you want to use for your shoot.
2. Set the exposure to the exposure that you want to use for your shoot.
3. Ensure that the sensor is as dark as possible.
 - ▶ Preferably, take off the lens, and install the front body cap.
 - ▶ If you cannot take off the lens, put a lens cap on the lens. (Not all lens caps completely block IR. Lens caps are made to protect the lens, not necessarily to block light.)
 - ▶ If possible, use a dark room.
 - ▶ Just closing the aperture is NOT sufficient.
4. Go to **Menu > Settings > Maintenance > Calibrate > Sensor > Create > Manual**.
5. Select how many calibration maps that you want to create from the **Number of captures** drop-down menu. You can create up to four (4) calibration maps at a time.
6. Select the exposure that you want for each calibration map from the **Capture** drop-down menus.
7. Select **Start Capture(s)**.
8. Select **OK** on the dialog box that opens. The system initializes and then makes multiple passes through the following phases of the calibration:
 - ▶ Capturing
 - ▶ Analyzing
 - ▶ Erasing
 - ▶ Programming
9. When the Calibration Successful dialog displays, select **OK** to complete the process.
The new calibration map is automatically selected.

DSMC2 MONSTRO OPERATION GUIDE

CALIBRATE SENSOR: AUTO CALIBRATION

NOTE: The camera cannot export calibration maps created by Auto Calibration.

The camera offers two (2) ways to calibrate the sensor: Manual Calibration and Auto Calibration. This section describes how to calibrate the sensor with Auto Calibration.

When you start an Auto Calibration, the camera calibrates the sensor at 16 exposure settings, and uses that data to build a calibration curve. Afterward, the sensor is calibrated for each exposure along the calibration curve, so you do not need to re-calibrate every time you change the exposure.

The calibration process does not factor in multiple temperatures, so you will need to re-calibrate the sensor after extreme changes in temperature.

This process can take up to 1 hour.

AUTO CALIBRATION PROCEDURE

To perform an Auto Calibration, follow the instructions below:

1. Ensure that the camera reaches the temperature that you want to use for your shoot.
2. Ensure that the sensor is as dark as possible.
 - ▶ Preferably, take off the lens, and install the front body cap.
 - ▶ If you cannot take off the lens, put a lens cap on the lens. (Not all lens caps completely block IR. Lens caps are made to protect the lens, not necessarily to block light.)
 - ▶ If possible, use a dark room.
 - ▶ Just closing the aperture is NOT sufficient.
3. Ensure a properly formatted SSD is attached to the camera.
4. Go to **Menu > Settings > Maintenance > Calibrate > Sensor > Create > Auto**.
5. Select **OK** on the dialog box that opens. The system initializes and then makes multiple passes through the calibration phases.
6. When the Calibration Successful dialog displays, select **OK** to complete the process.

NOTE: When you change the exposure setting, the E indicator turns yellow and it may take up to 8 seconds for the calibration map to load.

DSMC2 MONSTRO OPERATION GUIDE

CALIBRATION MAP NAMING CONVENTIONS

Each calibration map has a unique name that uses the format described in the table below:

NAME	DESCRIPTION	EXAMPLE
Exposure	Current exposure; to set exposure, go to " Exposure/Shutter " on page 115 If the calibration map was created using Auto Calibration, then "auto" displays instead of an exposure setting	48 auto
Sensor Temperature	Sensor temperature (Celsius); in the Lower Status Row, this is the number to the left of the forward slash (Temp: 32/35)	32C
Year	Year that the calibration map is created (yyyy)	2014
Month	Month that the calibration map is created (mm)	01
Day	Day that the calibration map is created (dd)	28
Letters	Two random alphanumeric characters generated by the camera to prevent any LQ possibility of duplicate names being created	

For example, a set of calibration maps may look like this:

- ▶ auto_39C_2000010300
- ▶ 48_39C_20000103NB
- ▶ 24_37C_20160105AT

NOTE: If you mount an SSD with calibration files to your computer, each calibration map displays as a sub-folder in a folder called Calibration. To save a calibration map to your hard drive, copy the entire sub-folder to your drive.

CALIBRATION MANAGEMENT

To apply, export, and import calibration maps, go to **Menu > Settings > Maintenance > Calibrate > Sensor**.

- ▶ **In Camera:** The calibration maps that are saved internally on the camera:
 - ▶ **Factory:** This is the calibration map generated during the manufacturing process. (Default)
 - ▶ **All other:** The user-created calibration maps.
- ▶ **Media:** The calibration maps that are on the SSD in the path shown (for example, S-SSD\calibration).

CALIBRATION MAP ACTIONS

NOTE: You cannot delete or rename the factory map.

- ▶ **Apply:** Apply the selected calibration map (if the calibration map is on the SSD, the camera applies the map temporarily, and does not import it into the camera).
- ▶ **Create:** Create a calibration map. For more information, go to "[Calibrate Sensor: Manual Calibration](#)" on page 160 and "[Calibrate Sensor: Auto Calibration](#)" on the previous page.
- ▶ **Delete:** Delete the selected camera calibration map.
- ▶ **Rename:** Rename the selected calibration map.

EXPORT AND IMPORT CALIBRATION MAPS

NOTE: The camera cannot export calibration maps created by Auto Calibration.

Calibration maps can be stored on the camera or transferred to SSD. You can also build a library of calibration maps to use in different settings. A camera only imports calibration maps that it created. Calibration maps cannot be shared between cameras.

- ▶ ➡ : Export selected calibration map from camera to SSD.
- ▶ ➡ **All:** Export all files from camera to SSD.
- ▶ ⬅ : Import selected calibration map from SSD to camera. This overwrites the user HS calibration map.
- ▶ ⬅ **All:** Import all files from SSD to camera.

CHAPTER 7: AUDIO SYSTEM

AUDIO OVERVIEW

The BRAIN has two (2) integrated dual channel digital stereo microphones that record uncompressed audio at 24-bit 48 kHz. These microphones offer you the ability to capture scratch-track audio.

The DSMC2 Base Expander, DSMC2 V-Lock I/O Expander, DSMC2 REDVOLT Expander, and DSMC2 Production Module each feature a built-in headphone jack, so you can hear the audio during playback via headphones. Together, the integrated microphones and headphone jack offer an audio solution for run-and-gun shoots.

Additional audio input/output options are determined by the attached expander or module. For the highest level of professional audio recording, RED recommends using the DSMC2 REDVOLT Expander or DSMC2 Production Module, which feature two (2) full-size XLR audio jacks.

The camera can record up to four (4) discrete stereo channels of uncompressed 24-bit, 48 kHz audio.

Input signals are routed via a high-quality pre-amplifier to achieve the desired recording levels and maximize dynamic range.

Audio data is synchronized with video and timecode and embedded in the R3D® file. You can export audio data from REDCINE-X PRO® as separate audio files.

Audio is also embedded in any HD-SDI and HDMI® output connected to the camera (except the MON-1 signal).

NOTE: If using a third-party module, some audio controls may not be available in-camera.

SET UP AUDIO

To set up audio, go to **Menu > Settings > Audio**. To adjust the input, pre-amplifier, and headphone settings, select **Control**. To adjust the mix settings, select **Mix**.

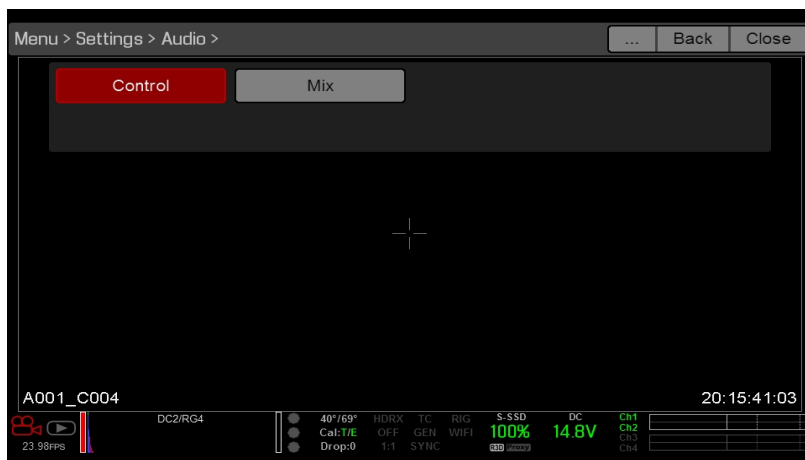

Figure: Audio Menu

DSMC2 MONSTRO OPERATION GUIDE

CONTROL

NOTE: If using a third-party module, some audio controls may not be available in-camera.

To adjust the input, pre-amplifier, and headphone settings, select **Control**.

CHANNEL 1/2 AND CHANNEL 3/4

To set up Channel 1/2 and 3/4, go to **Menu > Settings > Audio > Control**.



Figure: Channel Setup

SOURCE

The audio source options only display when the expanders are attached.

SOURCE NAME	CHANNEL PAIRS	DEVICE	CONNECTORS
None	N/A	N/A	N/A
Camera Internal	Ch1/Ch2, Ch3/Ch4	DSMC BRAIN	Mic 1 (Ch1 and Ch3) Mic 2 (Ch2 and Ch4)
Rear Analog	Ch1/Ch2, Ch3/Ch4	DSMC2 Base Expander DSMC2 V-Lock I/O Expander	Stereo Microphone
Rear Analog	Ch1/Ch2, Ch3/Ch4	DSMC2 REDVOLT Expander DSMC2 Production Module	AUDIO 1 and AUDIO 2 (full-size XLR)

NAME

You can rename each audio channel. The default names are Ch1, Ch2, Ch3, and Ch4. The channel names display in the Audio Meter, but are not included in the clip metadata.

MODE

When Rear Analog is selected, the Mode (Line, Mic, or +48V) displays for the incoming audio signal.

DSMC2 MONSTRO OPERATION GUIDE

PHANTOM POWER

The 3-pin XLR connectors on the DSMC2 REDVOLT Expander and DSMC2 Production Module provide +48 V phantom power.

Enable phantom power (via the switch adjacent to the XLR port) after a microphone is connected. Disable phantom power (by switching to Line or Mic) before removing the microphone.

PRE-AMP GAIN

The range and default depends on the attached expander.

To adjust amplification levels, follow the instructions below:

1. Go to **Menu > Settings > Audio > Control > Pre-Amp Gain**.
2. Move the **Pre-Amp** (pre-amplifier) sliders up and down to adjust the amplification levels.
3. To link the amplification for each channel, select **Link**.

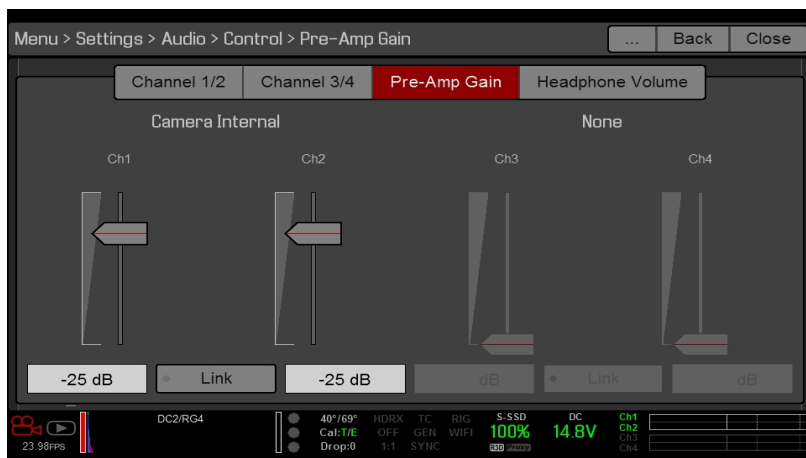

Figure: Pre-Amp Gain

DSMC2 MONSTRO OPERATION GUIDE

HEADPHONE VOLUME

The range and default depends on the attached expander.

CHANGE HEADPHONE VOLUME

1. Go to **Menu > Settings > Audio > Control > Headphone Volume**.
2. Move the **Left** and **Right** sliders up and down to adjust the volume.
3. To toggle mute/unmute, select **Mute**. (Applicable to DSMC2 Base Expander and DSMC2 V-Lock I/O Expander only.)
4. To link the volume for Left and Right, select **Link**.

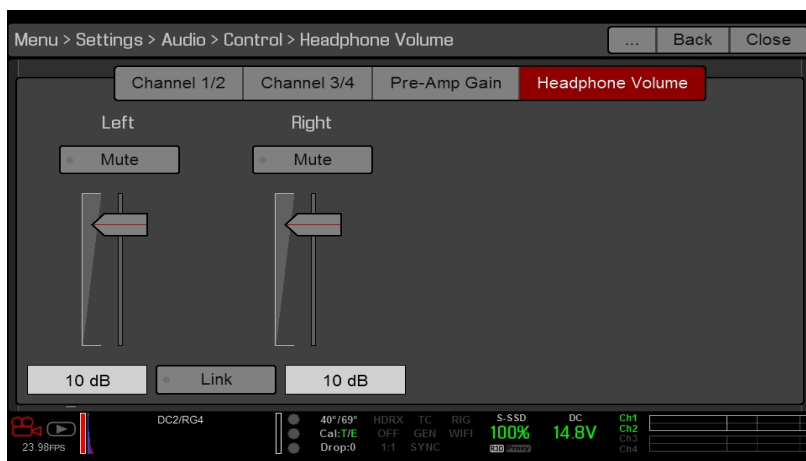

Figure: Headphone Volume

DSMC2 MONSTRO OPERATION GUIDE

MIX

NOTE: If using a third-party module, some audio controls may not be available in-camera.

NOTE: For DSMC2 Jetpack Expander and DSMC2 Jetpack-SDI Expander, the only available option is Monitor Mix.

The camera features a digital audio mixer that controls the volume and stereo settings for each input channel. The mixer affects audio monitoring (such as headphones) and audio recorded to external devices. The mixer DOES NOT affect audio embedded in the R3D file. To access mix settings, go to **Menu > Settings > Audio > Mix**.

The range for each channel is 0% to 100%. The default for each active channel is 100%. Channel 3 and Channel 4 are active only when there is audio input.

The digital mixer normalizes each output to prevent the output from exceeding the signal range. For example, if you pass Channel 1 to an output at 100%, and then mix Channel 2 into the same output, the level of Channel 1 decreases to 50%.

Assign each audio channel to the Left, Middle, or Right side of the stereo mix. Move the sliders up and down to adjust the volume.

You can control the volume and stereo for each audio monitoring option:

- ▶ **Headphone Mix:** Headphones plugged into the camera.
- ▶ **Audio Out Mix:** Line out plugged into an expander or module. The input gain is fixed.
- ▶ **Monitor Mix:** External HDMI and HD-SDI monitors that support audio.

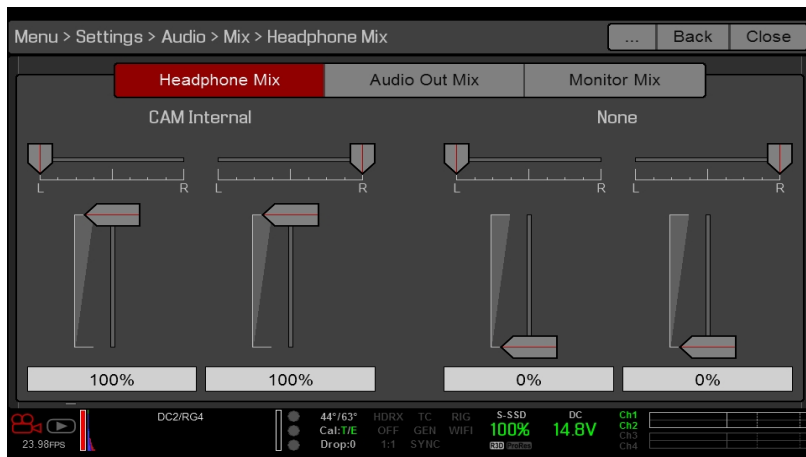

Figure: Mix

AUDIO OUTPUT OPTIONS

- ▶ **DSMC2 Base Expander, DSMC2 V-Lock I/O Expander, DSMC2 REDVOLT Expander, DSMC2 Production Module:** One (1) 2-channel headphone output. For maximum quality, use high impedance headphones.
- ▶ **HDMI and HD-SDI monitor:** Both output two (2) channels of 24-bit 48 kHz uncompressed, embedded digital audio. Select and mix the stereo channels in the Monitor Mix menu at **Menu > Settings > Audio > Mix > Monitor Mix**. To monitor audio via HDMI or HD-SDI, the third-party monitor must support audio.

AUDIO METER (VU METER)

The Audio Meter displays at the bottom-right corner of the viewfinder, and displays either the incoming audio channels (default), or the outgoing audio (mixes). For more information, go to "[VU Meter](#)" on page 98.

DSMC2 MONSTRO OPERATION GUIDE

INCOMING AUDIO CHANNELS

When you select Input as the VU Meter Source, the Audio Meter displays the incoming audio channels (default). For more information, go to ["VU Meter" on page 98](#). Channel 1 and Channel 2 are the default channels, correlating with the MIC-1 and MIC-2 inputs on the camera. Channel 3 and Channel 4 are greyed out unless the camera detects audio input.

The channel names selected in the Audio menu determine the channel names displayed in the Audio Meter.

The Audio Meter shows the incoming audio signal when a source is selected, even if the channel is not recorded. When a channel is recorded, the channel indicator left of the Audio Meter is green.

OUTGOING AUDIO

When you select Output as the VU Meter Source, the Audio Meter displays the Headphone Mix, Audio Out Mix, and Monitor Mix levels. For more information, go to ["VU Meter" on page 98](#).

When recording to an external device, use the Output levels to help accurately monitor recorded audio.

AUDIO METER LEVELS



Figure: Audio Meter

The camera updates the Audio Meter 12 times per second with the maximum signal from the last 1/12 of a second period. The range of the Audio Meter is -52 dBFS to 0 dBFS.

The lines and colors indicate danger of clipping, as described in the table below:

LINE	DBFS	COLOR	DESCRIPTION
First line (far left border; solid)	-52 dBFS	Green	Audio is not clipping
Second line (solid)	-20 dBFS	Green	Audio is not clipping
Third line (dashed)	-12 dBFS	Yellow	Audio close to clipping
Fourth line (dashed)	-2 dBFS	Red	Audio is clipping
Fifth line (far right border; solid)	0 dBFS	Red	Audio is clipping (if signal exceeds -1 dBFS, the whole bar is red)

NOTE: In the American broadcast and post production systems, -20 dBFS roughly corresponds to 0 VU and 4 dBu. In a digital system, dBu is an approximation; the correct unit for digital audio levels is dBFS.

AUDIO DURING PLAYBACK

The camera plays all recorded channels during playback (via headphones or HDMI and HD-SDI monitors), and automatically unmutes any muted audio outputs.

To access audio settings during playback, go to **Menu > Settings > Audio** and select the following tabs:

- ▶ Control
- ▶ Mix

DSMC2 MONSTRO OPERATION GUIDE

RECORD AUDIO IN VARISPEED MODE

The camera supports recording audio in Varispeed mode when all of the following criteria is met:

- ▶ The Recording Frame Rate is higher than the Project Time Base
- ▶ The Recording Storage is set to Local, and the Recording mode is set to Continuous Record (Menu > Settings > Recording > Mode)
- ▶ The Record varispeed audio in a separate WAV file check box is selected (Menu > Settings > Recording > Mode)
- ▶ The Record File Format includes R3D (Menu > Settings > Recording > Codec)

To record audio in Varispeed mode, follow the instructions below:

1. Set the Recording Frame Rate to a higher rate than the Project Time Base. The camera cannot record audio when the Recording Frame Rate is lower than the Project Time Base. For more information, go to ["Frame Rate" on page 114](#).



Figure: Enable Varispeed

2. Go to **Menu > Settings > Recording > Mode**.
3. Select **Local** from the **Storage** drop-down menu.
4. Select **Continuous Record** from the **Mode** drop-down menu.

DSMC2 MONSTRO OPERATION GUIDE

5. Select the **Record varispeed audio in a separate WAV file** check box. This option is available only when the Recording Frame Rate is higher than the Project Time Base.

The Audio Meters display in the Lower Status Row. For more information, go to "[Audio Meter \(VU Meter\)](#)" on [page 168](#).



Figure: Record Varispeed Audio

6. Record.
7. When you mount the SSD to a computer, a WAV file displays in the RDC folder.

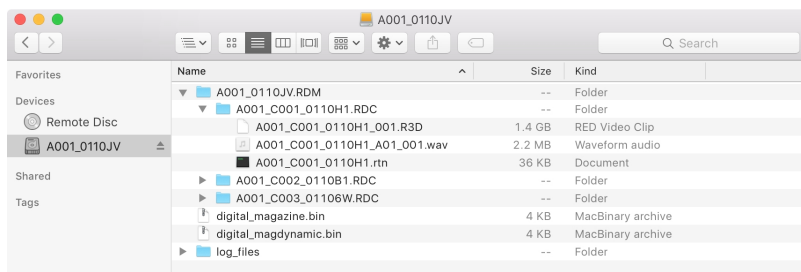

Figure: WAV File in RDC Folder

CHAPTER 8:

TIMECODE, GENLOCK, MULTI-CAMERA SETUP

This chapter describes timecode, genlock, and multi-camera operations such as 3D and array setup.

NOTE: These configurations require specific expanders or modules. For more information, go to ["Input/Output Connectors" on page 218](#).

TIMECODE

Timecode is a numeric sequence based on SMPTE 12M that aids in the management and synchronization of footage and audio. Timecode is embedded in recorded RAW files, QuickTime® files (if recording an Apple® ProRes codec), and MXF files (if recording an Avid® codec) as metadata and in HANC metadata provided by the HD-SDI monitor output. The camera can generate timecode on its own or can receive and sync to timecode generated by an external source. RED cameras use non-drop frame timecode.

Timecode displays in the lower right corner of the Live Action Area on the graphical user interface (GUI) and is embedded as metadata. Timecode is represented as an eight (8) digit sequence (HH:MM:SS:FF), where:

- ▶ **HH:** Hours
- ▶ **MM:** Minutes
- ▶ **SS:** Seconds
- ▶ **FF:** Frames

NOTE: Timecode is most accurate and effective when coupled with genlock. For more information, go to ["Genlock" on page 175](#).

NOTE: For more information on HANC metadata, see [HD-SDI HANC Metadata Information](#), available at www.red.com/developers.

DSMC2 MONSTRO OPERATION GUIDE

SET UP INTERNAL TIMECODE

To set up and adjust timecode generated by the camera, follow the instructions below:

1. Go to **Menu > Settings > Project > Timecode**.
2. Select the desired **Timecode Display** mode.
3. Set **Source** to **RTC**.

The **TC** indicator in the Lower Status Row remains grey when internal timecode is enabled.



Figure: Timecode

OUTPUT TIMECODE

NOTE: Outputting timecode from the camera requires a DSMC2 REDVOLT Expander or DSMC2 Production Module.

To output a timecode signal to an external device or slaved camera, follow the instructions below:

1. Follow the instructions in "[Set Up Internal Timecode](#)" above to set up internal timecode.
2. Connect the camera to another device using the PRO I/O TIMECODE CABLE (3').
 - A. Connect one connector to the **TIMECODE** port on the expander or module.
 - B. Connect the other connector to an external device or camera.

REQUIRED CABLE

- ▶ **790-0212: PRO I/O TIMECODE CABLE (3')**

DSMC2 MONSTRO OPERATION GUIDE

INPUT EXTERNAL TIMECODE

NOTE: This procedure requires a DSMC2 Base Expander, DSMC2 V-Lock I/O Expander, DSMC2 Jetpack Expander, DSMC2 Jetpack-SDI Expander, DSMC2 REDVOLT Expander, or DSMC2 Production Module. For more information, go to ["Input/Output Connectors" on page 218](#).

To input timecode generated by an external device, follow the instructions below:

1. Connect the external timecode generator to the camera:
 - ▶ **DSMC2 Base Expander, DSMC2 V-Lock I/O Expander, DSMC2 Jetpack Expander, or DSMC2 Jetpack-SDI Expander:** Connect the **SYNC** port (4-Pin 00B) on the expander to the device (yellow BNC) using a 3BNC-to-00 Sync Cable.
 - ▶ **DSMC2 REDVOLT Expander or DSMC2 Production Module:** Connect the **TIMECODE** port on the expander or module to the device using a 75 ohm BNC cable.
2. Go to **Menu > Settings > Project > Timecode**.
3. Select the desired **Timecode Display Mode**.
4. Set **Source** to **External**.

The **TC** indicator in the Lower Status Row turns green when an external timecode source is locked.

NOTE: When an external source is selected but not present, timecode displays User Provided settings.

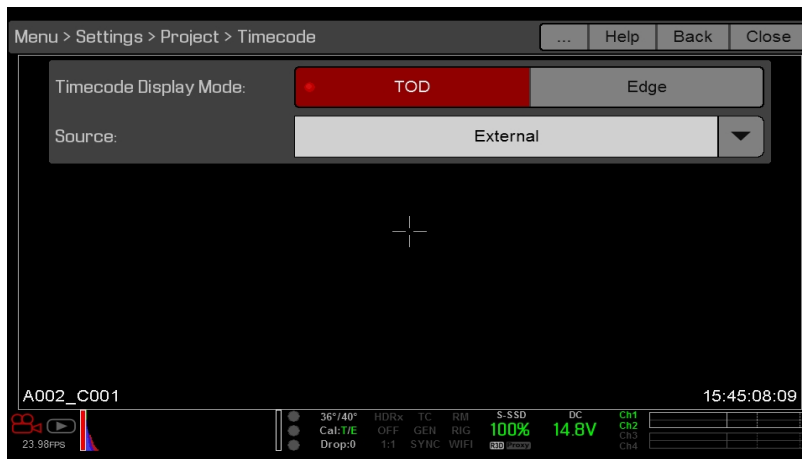

Figure: Source: External

REQUIRED CABLE

- ▶ **DSMC2 Base Expander, DSMC2 V-Lock I/O Expander, DSMC2 Jetpack Expander, or DSMC2 Jetpack-SDI Expander:** 790-0154, 790-0643, 3BNC-to-00
- ▶ **DSMC2 REDVOLT Expander or DSMC2 Production Module:** 790-0212, PRO I/O TIMECODE CABLE (3')

DSMC2 MONSTRO OPERATION GUIDE

GENLOCK

Generator locking (genlock) is a tri-level signal used to synchronize video and audio systems. Genlock is based on SMPTE 296M and 274M. There are two (2) important genlock sync modes:

- ▶ Monitor Sync
- ▶ Sensor Sync

MONITOR SYNC

NOTE: Using genlock requires a DSMC2 Base Expander, DSMC2 V-Lock I/O Expander, DSMC2 Jetpack Expander, DSMC2 Jetpack-SDI Expander, DSMC2 REDVOLT Expander, or DSMC2 Production Module. For more information, go to "[Input/Output Connectors](#)" on page 218.

Monitor Sync occurs when an incoming genlock signal is compatible with the monitor output frequency. Monitor Sync is achievable even if the camera is using another form of synchronization to sync the camera sensor.

1. Connect the genlock device to the camera:
 - ▶ **DSMC2 Base Expander, DSMC2 V-Lock I/O Expander, DSMC2 Jetpack Expander, or DSMC2 Jetpack-SDI Expander:** Connect the **SYNC** port (00B) on the expander to the device (green BNC) using a 3BNC-to-00 Sync Cable.
 - ▶ **DSMC2 REDVOLT Expander or DSMC2 Production Module:** Connect the **GENLOCK** port on the expander or module to the device using a 75 ohm BNC cable.
2. Set up the frequency for the HD-SDI output (select **Auto** to automatically match the HD-SDI output to the current Project Time Base). For more information, go to "[Frequency](#)" on page 88.

Monitor Sync is achieved automatically when an incoming genlock signal is compatible with the monitor output frequency. When Monitor Sync is achieved, the **GEN** indicator in the Lower Status Row illuminates green.

REQUIRED CABLE

- ▶ **DSMC2 Base Expander, DSMC2 V-Lock I/O Expander, DSMC2 Jetpack Expander, or DSMC2 Jetpack-SDI Expander:** 790-0154, 790-0643, 3BNC-to-00
- ▶ **DSMC2 REDVOLT Expander or DSMC2 Production Module:** 75 ohm BNC cable (such as the RED HD-SDI Cable, P/N 790-0341)

DSMC2 MONSTRO OPERATION GUIDE

SENSOR SYNC

NOTE: HDRX® is not available when Genlock Sensor Sync is enabled.

Sensor Sync is achieved when an incoming genlock signal is compatible with the monitor output frequency, project time base, and recording frame rate. In Sensor Sync mode, sensor timing is locked to the genlock signal. Sensor Sync requires the following synchronized settings:

SETTING	MENU LOCATION PATH
Genlock signal frequency	N/A; external genlock device
HD-SDI monitor output frequency	Menu > Monitoring > Monitors > select monitor
Project Time Base	Menu > Settings > Project > Frame Rate
Recording Frame Rate	Menu > Settings > Project > Frame Rate

SET UP SENSOR SYNC MODE

NOTE: Using genlock requires a DSMC2 Base Expander, DSMC2 V-Lock I/O Expander, DSMC2 Jetpack Expander, DSMC2 Jetpack-SDI Expander, DSMC2 REDVOLT Expander, or DSMC2 Production Module. For more information, go to ["Input/Output Connectors" on page 218](#).

To set up and enable Sensor Sync Mode, follow the instructions below:

1. Ensure that the Project Time Base and Recording Frame Rate will be compatible with the incoming genlock signal.
2. Connect the genlock device to the camera:
 - ▶ **DSMC2 Base Expander, DSMC2 V-Lock I/O Expander, DSMC2 Jetpack Expander, or DSMC2 Jetpack-SDI Expander:** Connect the **SYNC** port (00B) on the expander to the device (green BNC) using a 3BNC-to-00 Sync Cable.
 - ▶ **DSMC2 REDVOLT Expander or DSMC2 Production Module:** Connect the **GENLOCK** port on the expander or module to the device using a 75 ohm BNC cable.
3. Go to **Menu > Settings > Setup > GPIO/Sync > Sync**.
4. Select **Genlock** from the **Sensor Sync Mode** drop-down menu.
5. Set up the frequency for the HD-SDI output (select **Auto** to automatically match the HD-SDI output to the current Project Time Base). For more information, go to ["Frequency" on page 88](#).

The **GEN** indicator in the Lower Status Row turns green when a compatible genlock signal is present and genlock is enabled. The **SYNC** indicator in the Lower Status Row turns green when Sensor Sync is achieved.

REQUIRED CABLE

- ▶ **DSMC2 Base Expander, DSMC2 V-Lock I/O Expander, DSMC2 Jetpack Expander, or DSMC2 Jetpack-SDI Expander:** 790-0154, 790-0643, 3BNC-to-00
- ▶ **DSMC2 REDVOLT Expander or DSMC2 Production Module:** 75 ohm BNC cable (such as the RED HD-SDI Cable, P/N 790-0341)

DSMC2 MONSTRO OPERATION GUIDE

MASTER/SLAVE OPERATION

NOTE: Master/Slave operation, including stereo/3D and camera arrays, requires a GIG-E port, which is available on the DSMC2 Jetpack-SDI Expander, DSMC2 REDVOLT Expander, and DSMC2 Production Module. For more information, go to "[GIG-E \(Ethernet\)](#)" on page 237.

NOTE: The Master camera controls metadata and basic camera parameters of the Slave cameras. Any other setting changes required by the Slave cameras must be made before recording.

This section describes operation in Master/Slave configuration and clip naming conventions for clips recorded on those cameras. Master/Slave is the most common configuration for Stereo/3D productions.

When cameras are operated in Master/Slave configuration, you can perform the following operations:

- ▶ **Power:** Turn off the Master camera to turn off both cameras.
- ▶ **Record:** Press the **PWR/REC** key on the Master camera to start/stop recording on both cameras.
- ▶ **Change settings:** Change settings on the Master camera, to change settings on the Slave camera.

For a Master/Slave configuration to function, the cameras must have the same:

- ▶ Firmware version
- ▶ Project time base
- ▶ Recording frame rate
- ▶ BRAIN
- ▶ Sensor

DSMC2 MONSTRO OPERATION GUIDE

SET UP MASTER/SLAVE OPERATION

NOTE: Master/Slave operation, including stereo/3D and camera arrays, requires a GIG-E port, which is available on the DSMC2 Jetpack-SDI Expander, DSMC2 REDVOLT Expander, and DSMC2 Production Module. For more information, go to "[GIG-E \(Ethernet\)](#)" on page 237.

1. Use the Master/Slave Gig-E Cable to connect the **GIG-E** port on one expander or module to the **GIG-E** port on the other expander or module.
2. On the Master camera, follow the instructions below:
 - A. Go to **Menu > Settings > Setup > Communication**.
 - B. Type a name for the camera (Example: CAM A, LEFT, MASTER, etc) in the **Camera ID** field.
 - C. Set **Target** to **All**.



Figure: Master Settings

- D. Go to **Menu > Settings > Setup > Communication** and select the **Ethernet** tab.
- E. Select the **Camera to Camera** the check box.

DSMC2 MONSTRO OPERATION GUIDE

3. On the Slave camera(s), follow the instructions below:
 - A. Go to **Menu > Settings > Setup > Communication**.
 - B. Type a name for the camera (Example: CAM B, RIGHT, SLAVE, etc) in the **Camera ID** field.
 - C. Set **Target** to **None**.



Figure: Slave Settings

- D. Go to **Menu > Settings > Setup > Communication** and select the **Ethernet** tab.
- E. Select the **Camera to Camera** check box.

The LAN indicator in the Lower Status Row illuminates green.

NOTE: Cameras can also be set up in a Master/Master configuration. To set up Master/Master, set **Target** to **All** on both cameras, allowing either camera to make changes and control record start/stop.

REQUIRED CABLE

- ▶ **790-0163:** Master/Slave Gig-E Cable (4')

DSMC2 MONSTRO OPERATION GUIDE

SET REEL NUMBER, CAMERA ID, AND CAMERA POSITION

NOTE: Camera ID and Camera Position settings can also be found at **Menu > Settings > Project > Slate > Camera**.

To prepare media and slate settings for a Master/Slave or Stereo/3D production, follow the instructions below:

1. On both Master and Slave cameras, go to **Menu > Media > Device** and select **Format Media...**
2. On both Master and Slave cameras, select the desired **Reel Number** and **Camera ID** settings. The Reel Number and Camera ID settings on both cameras should match.
3. On the Master camera, change the **Camera Position** to **Left**, representing “left eye”.

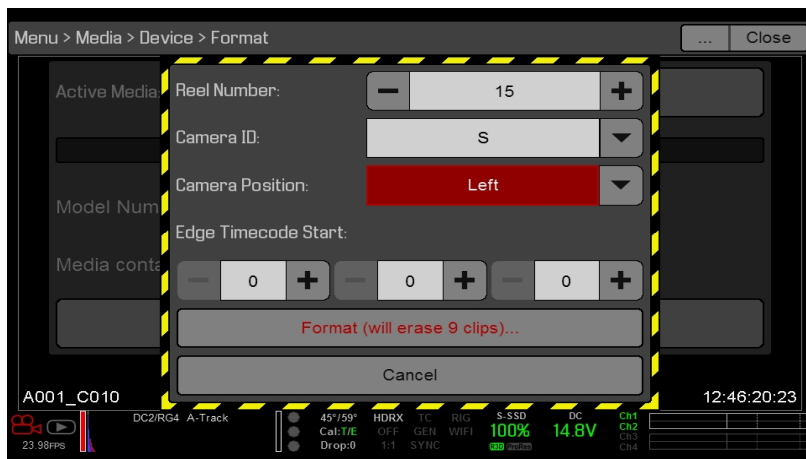

Figure: Master Settings

4. On the Slave camera, change the **Camera Position** to **Right**, representing “right eye”.
5. On both cameras, select **Format...** to format media and set the Reel Number, Camera ID, and Camera Position settings.

DSMC2 MONSTRO OPERATION GUIDE

MULTI-CAMERA CLIP NAMING CONVENTIONS

This section describes automatic camera-generated clip naming conventions based on slate settings. Cameras use the Reel No, Cam ID, and Cam Pos settings to generate a custom clip name.

For example, if you have two (2) cameras in Master/Slave configuration and format media on both cameras with the following settings:

CAMERA	REEL NUMBER	CAMERA ID	CAMERA POSITION
Master	1	S	Left
Slave	1	S	Right

The first clip recorded by this Master/Slave camera configuration is:

- ▶ **Master:** S001_L001_0503B6.R3D
- ▶ **Slave:** S001_R001_0503R7.R3D

NOTE: B6 and R7 are examples of camera-generated wildcard characters.

NOTE: If both cameras have a Camera Position of Left, the recorded clips will have the same filename structure, with the exception of the camera-generated wildcard characters. For example:

- ▶ **Master:** A001_C001_0503B6.R3D
- ▶ **Slave:** A001_C001_0503R7.R3D

NOTE: Reel Number, Camera ID, and Camera Position can be set when formatting media.

DSMC2 MONSTRO OPERATION GUIDE

SET UP STEREO/3D CONFIGURATION

NOTE: Master/Slave operation requires a GIG-E port, which is available on the DSMC2 Jetpack-SDI Expander, DSMC2 REDVOLT Expander, and DSMC2 Production Module. For more information, go to "[GIG-E \(Ethernet\)](#)" on [page 237](#).

This section describes basic procedures for connecting two (2) cameras in a Master/Slave configuration for 3D operation.

NOTE: When providing the signals to a Stereo Image Processor (SiP) for verifying 3D alignment, set the HD-SDI monitor output on both cameras to have the same overlay configuration.

NOTE: For genlock to function correctly, the cameras must be on the same firmware version, and must be using the same project time base and recording frame rate.

To set up a Stereo/3D setup, follow the instructions below.

1. On both cameras, set the project time base and recording frame rate.
2. On both cameras, follow the instructions in "[Sensor Sync](#)" on [page 176](#) to achieve Sensor Sync genlock status.
The **GEN** and **SYNC** indicators in the Lower Status Row illuminate green.
3. Follow the instructions in "[Set Up Master/Slave Operation](#)" on [page 178](#) to set Master and Slave camera settings.
4. On both cameras, follow the instructions in "[Set Reel Number, Camera ID, and Camera Position](#)" on [page 180](#) to set up media and camera settings.

REQUIRED CABLES

Use one (1) per camera:

- ▶ 75 ohm BNC cable (such as the RED HD-SDI Cable, P/N 790-0341)

Use one (1) per setup:

- ▶ **790-0163:** Master/Slave Gig-E Cable (4')

DSMC2 MONSTRO OPERATION GUIDE

CAMERA ARRAY

SET UP A CAMERA ARRAY

NOTE: Master/Slave operation, including stereo/3D and camera arrays, requires a GIG-E port, which is available on the DSMC2 Jetpack-SDI Expander, DSMC2 REDVOLT Expander, and DSMC2 Production Module. For more information, go to "[GIG-E \(Ethernet\)](#)" on page 237.

NOTE: For genlock to function correctly, the cameras must be on the same firmware version, and must be using the same project time base and recording frame rate.

NOTE: To operate a camera array setup from a Windows® computer or workstation, you need one of several applications provided by RED® or third-party developers.

You can sync more than two (2) cameras for applications and productions that require a camera array. To set up a camera array, you need a 1000Base-T gigabit Ethernet router.

For more information on camera control, see the [R.C.P.™ SDK](#), available at www.red.com/developers.

To set up a camera array, follow the instructions below:

1. On each camera, go to **Menu > Settings > Setup > Communication** and set the following:
 - A. On the **Camera** tab, set **Target** to **All**.
 - B. On the **Camera** tab, enter a matching name in the **Group ID** field. All cameras must have the same Group ID name.
 - C. On the **Ethernet** tab, select the **DHCP**, **Camera to Camera**, and **External Control** check boxes.
2. Follow the instructions in "[Sensor Sync](#)" on page 176 to connect each camera to the genlock device.
The **GEN** and **SYNC** indicators in the Lower Status Row illuminate green.
3. Follow the instructions in "[Set Up Master/Slave Operation](#)" on page 178 to set Master and Slave camera settings. Instead of using the Master/Slave Gig-E Cable, connect each camera to the router using a 9-Pin 0B GIG-E-To-CAT5E Ethernet Cable.
 - A. Connect the LCD/EVF connector to the **GIG-E** port on the expander or module.
 - B. Connect the Ethernet connector to the router.
4. On each camera, follow the instructions in "[Set Reel Number, Camera ID, and Camera Position](#)" on page 180 to prepare media and camera settings.

REQUIRED CABLES

Use one (1) per camera:

- ▶ **790-0154, 790-0643:** 3BNC-to-00 Sync Cable
- ▶ **DSMC2 REDVOLT Expander, DSMC2 Jetpack-SDI Expander or DSMC2 Production Module:** 75 ohm BNC cable (such as the RED HD-SDI Cable, P/N 790-0341)

Use one (1) of the following per setup:

- ▶ **790-0159:** RED GIG-E Straight-to-CAT5E Ethernet Cable (9')
- ▶ **790-0557, 790-0655:** RED GIG-E Right-to-CAT5E Ethernet Cable (9')

DSMC2 MONSTRO OPERATION GUIDE

MOTION CONTROL (MOCO)

NOTE: When using MoCo, set the frame rate to be at least two times (2x) the fastest trigger rate used. When using MoCo, REDCODE is calculated based on fps/2. Therefore, if you are in MoCo mode, and the frame rate is 100.83 fps, the maximum REDCODE is calculated based on a frame rate of 50.415 fps.

NOTE: HDRX is not available when MoCo is enabled.

NOTE: Genlock and timecode can also be used with MoCo.

Motion Control (MoCo) is a form of sensor synchronization used to automate precision camera movements required for special effects and difficult shots. Motion Control uses GPIO signals transmitted using the SYNC (GPI) and CTRL (GPO) ports on the DSMC2 Base Expander.

For more information on GPIO connections, go to ["Input/Output Connectors" on page 218](#).

SET UP MOTION CONTROL

NOTE: Motion Control requires a DSMC2 Base Expander. For more information, go to ["Input/Output Connectors" on page 218](#).

To set up Motion Control, follow the instructions below:

1. Connect the Motion Control device to the camera using a 3BNC-to-00 Sync Cable.
 - ▶ **Sync In:** Connect the white BNC connector to the Motion Control device and the 4-Pin 00B connector to the **SYNC** port on the expander.
 - ▶ **Sync Out:** Connect the yellow BNC connector to the Motion Control device and the 4-Pin 00B connector to the **CTRL** port on the expander.
2. Go to **Menu > Settings > Setup > GPIO/Sync > Sync**.
3. Select **MoCo** from the **Sensor Sync Mode** drop-down menu.

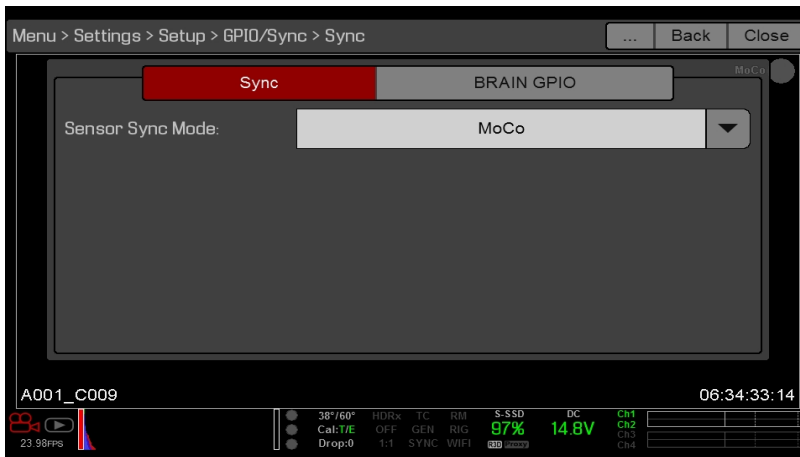

Figure: MoCo Sync Settings

4. Select the **BRAIN GPIO** tab.
5. Select **Sync In** from the **GPI Function** drop-down menu.

DSMC2 MONSTRO OPERATION GUIDE

6. Select **Sync Out** from the **GPO Function** drop-down menu. (Optional)



Figure: MoCo BRAIN GPIO Settings

7. Supply a pulse from the Motion Control device to sync the shutter to the rising edge of the sync input.

NOTE: For more information, refer to the manufacturer's instructions for the Motion Control device.

REQUIRED CABLE

- ▶ **790-0154, 790-0643:** 3BNC-to-00 Sync Cable (required per SYNC and CTRL port used)

DSMC2 MONSTRO OPERATION GUIDE

COMPATIBLE TIMECODE DEVICES

The following timecode devices are compatible with the camera. Additional timecode devices may be compatible, but have not yet been tested by RED.

- ▶ Ambient ACL 202CT
- ▶ Ambient LOCKIT ACL 203
- ▶ Ambient ACL 204
- ▶ Ambient ACC 501 Clockit Controller
- ▶ Ambient ACD-301 Lockit Slate
- ▶ Denecke SB-3 Syncbox Time-Code Generator
- ▶ Sound Devices 788T
- ▶ Sound Devices 744
- ▶ Sound Devices PIX-240
- ▶ Zaxcom Nomad 12
- ▶ Zaxcom ZFR100
- ▶ Zaxcom ZFR200

COMPATIBLE GENLOCK DEVICES

The following genlock devices are compatible with the camera. Additional genlock devices may be compatible, but have not yet been tested by RED.

- ▶ AJA® GEN10 HD/SD/AES Sync Generator with Universal Power Supply
- ▶ Ambient ACL 202CT
- ▶ Ambient ACL 203
- ▶ Ambient ACL 204
- ▶ Denecke SB-T
- ▶ Evertz Master Clock 5600MSC

NOTE: Ensure that your genlock device provides a full-strength genlock signal to each camera. Splitting a genlock signal weakens it, which may compromise the sync between cameras.

CHAPTER 9:

UPGRADE CAMERA FIRMWARE

Your camera functionality may be upgraded by installing the latest firmware. Make a habit of frequently visiting [RED Downloads](http://www.red.com/downloads) at www.red.com/downloads to check for new versions of camera firmware, updated operation guides, and post production software.

VERIFY CURRENT CAMERA FIRMWARE

To see the firmware version that is currently installed on your camera, go to **Menu > Settings > Maintenance > System Status > Camera Info**. A higher number reflects a later release.

UPGRADE CAMERA FIRMWARE

Install the most recent firmware. Unless otherwise specified in the release notes, you do not need to upgrade to any firmware in between your current version and the most recent version available online.

NOTE: You must calibrate the sensor after upgrading the camera. For more information, go to "[Sensor Calibration](#)" on [page 159](#).

NOTE: Preset, Look, and Custom Overlay files are preserved across upgrades to v6.2.3 or later.

NOTE: On Mac[®] computers with REDCINE-X PRO[®] installed, RED Watchdog mounts the SSD as Read-Only by default, which means that you are unable to write files (including firmware upgrade files) to the SSD. Change the **Mount** preference to **Read-Write** before attempting to copy firmware to the SSD.

1. Connect an SSD (RED MINI-MAG[®]) to your computer.
2. Download the most recent firmware for your camera from [RED Downloads](http://www.red.com/downloads) at www.red.com/downloads.
3. Unzip the firmware zip file.
4. Copy the **force_upgrade** folder and its contents to the top level of the SSD directory.
5. Eject or unmount the SSD, and then remove the SSD.
6. Ensure that the camera is turned off.
7. Insert the SSD with the force_upgrade folder into your camera.
8. Turn on the camera.

The upgrade runs automatically.

During upgrade, the fans run at high speed and the PWR and REC LEDs flash green. After approximately 15 seconds, the LEDs stop flashing and the camera turns off. Nothing displays on the external monitors during the upgrade.

9. After the camera turns off, remove the SSD and wait 10 seconds.
10. Turn on the camera.

The camera may take 30 seconds or longer to upgrade all of the attached RED devices. During this time the PWR and REC LEDs flash green and nothing displays on the external monitors.

11. If this is your first time upgrading firmware, a pop-up menu opens with the Software License Agreement (SLA). Select **Agree**. If you do not agree to the SLA, the camera cannot be used. The SLA continues to display until it is accepted.

DSMC2 MONSTRO OPERATION GUIDE

12. Verify that the firmware version listed matches the firmware version that you downloaded. For more information, go to ["Verify Current Camera Firmware" on the previous page](#).
13. Reformat the SSD before recording.

CHAPTER 10:

CAMERA SYSTEM MAINTENANCE

All RED® products are designed for rugged durability, but precision instruments demand proper care. Follow the instructions in this chapter to clean, maintain, and store your devices.

WARNING: DO NOT rinse or immerse the camera or other accessories in water. Keep dry at all times.

WARNING: DO NOT use soaps, detergents, ammonia, acetone, alkaline cleaners, abrasive cleaning compounds, or solvents. These substances may damage lens coatings and electronic circuitry.

WARNING: DO NOT use an excess of cleaning solution.

WARNING: DO NOT reuse swabs or wipes.

WARNING: DO NOT attempt to clean the sensor or optical cavity for any reason. If the sensor becomes dirty, submit a Support ticket at <https://support.red.com>.

WARNING: DO NOT attempt to modify, dismantle, or open the camera, lens, or other accessory as doing so may expose you to electric shock and serious injury. There are no user-serviceable parts inside. Alteration or repairs made to the camera, lens, or other accessory, except by a RED® authorized service facility, voids all warranties.

WARNING: Use caution with compressed air and gas dusters, since the high pressure, oily residue, cold air, particulates, and moisture may cause damage. You may use a filtered, non-residue gas duster to clean non-critical areas, such as around the fans and other recesses on the exterior of the camera. Damage to the camera or other components of the camera system caused by using compressed air or gas dusters is not covered under warranty.

WARNING: DO NOT use compressed air and gas dusters on the sensor or on any optics.

WARNING: DO NOT use compressed air and gas dusters on or around the integrated microphones on the front of the BRAIN.

BRAIN AND ACCESSORY EXTERIOR SURFACES

- ▶ Use a filtered, non-residue gas duster to clean non-critical areas, such as around the fans and other recesses on the exterior of the camera.
- ▶ Clean with a dry lint-free cloth. When cleaning your camera and accessories, remember that the devices are not waterproof and moisture can damage electronic circuitry.

STORAGE

RED recommends that you store the camera and accessories in the water-resistant cases available in the [RED Store](http://www.red.com/store) at www.red.com/store. These cases feature laser-cut foam to keep the camera and accessories secure.

WARNING: DO NOT store the camera or accessories in any place with extreme temperatures, direct sunlight, high humidity, severe vibration, or strong magnetic fields.

DSMC2 MONSTRO OPERATION GUIDE

CLEAN EVF SCREEN

NOTE: This section describes only how to clean the screen on the DSMC2® RED EVF, and not how to clean the entire device.

This section explains how to clean the screen on the DSMC2 RED EVF. The screen is accessed by removing the DSMC2 RED EVF Modular Optical Block.

Use an ionized rubber air bulb to clean the screen on the DSMC2 RED EVF. If there are still particles on the screen after using an air bulb, gently wipe the screen with a rolled-up, particulate-free, non-abrasive optical-grade wipe.

NOTE: Cleaning the screen without first removing solid particles increases the risk of scratching the screen. As with many screens, any type of physical contact with the screen may scratch the surface.

PROHIBITED EVF SCREEN CLEANERS

DO NOT use any of the items listed below to clean the screen on the DSMC2 RED EVF. These products have not been tested on RED products and may cause damage or streaking.

- ▶ Compressed air
- ▶ Gas dusters
- ▶ Solvents
- ▶ Rubbing alcohol
- ▶ Isopropyl alcohol
- ▶ Windex®
- ▶ Third-party cleaning kits
- ▶ Pre-packaged lens cleaner containing any additives, such as detergent, anti-static compounds, or fragrance
- ▶ RED Microfiber Bag

WARNING: Damage to any screens or other components of the camera system caused by using prohibited cleaners is not covered under warranty.

CLEAN LCD SCREENS

NOTE: This section describes only how to clean the screen on each specified device, and not how to clean the entire device.

This section explains how to clean the screens on the following devices:

- ▶ RED PRO LCD
- ▶ RED Touch LCD
- ▶ RED PRO Touch LCD
- ▶ DSMC2 SIDEKICK™

DSMC2 MONSTRO OPERATION GUIDE

APPROVED LCD SCREEN CLEANERS

Use only the following products to clean LCD screens:

- ▶ Ionized rubber air bulb
- ▶ Delkin Devices Sensor Solution®
- ▶ Lens swabs
- ▶ Dry optical wipes
- ▶ RED Microfiber Bag

NOTE: Before cleaning the screen with swabs or wipes and a cleaning solution, ALWAYS use an ionized rubber air bulb to remove any solid particles. Cleaning the screen without removing solid particles increases the risk of scratching the screen.

PROHIBITED LCD SCREEN CLEANERS

DO NOT use any of the items listed below to clean LCD screens. These products have not been tested on RED products and may cause damage or streaking.

- ▶ Compressed air
- ▶ Gas dusters
- ▶ Solvents
- ▶ Rubbing alcohol
- ▶ Isopropyl alcohol
- ▶ Windex
- ▶ Pancro Professional Lens Cleaner (or equivalent)
- ▶ Third-party cleaning kits
- ▶ Pre-packaged lens cleaner containing any additives, such as detergent, anti-static compounds, or fragrance

WARNING: Damage to any screens or other components of the camera system caused by using prohibited cleaners is not covered under warranty.

SCREEN STORAGE

Store any RED device with a screen in a RED Microfiber bag. Storing devices in a RED Microfiber bag preserves the superior quality of the specialized AR and AS coatings on the LCDs.

Hand wash and air-dry the RED Microfiber bag regularly.

WATER DAMAGE

If your device has come in contact with water or you suspect water damage, submit a Support ticket at <https://support.red.com> immediately.

WARNING: DO NOT attempt to power any device that may have water damage.

WARNING: DO NOT place the device in a container of rice, silica gel, or desiccant packets in an attempt to dry the device.

DSMC2 MONSTRO OPERATION GUIDE

ADJUST BACK FOCUS

Adjust back focus by using the RED Focus or a focus chart. For more information about using the RED Focus, see the [RED Focus Operation Guide](#), available at www.red.com/downloads.

The camera also features a back focus adjustment screw. For more information, go to "[BRAIN](#)" on [page 13](#).

CHAPTER 11: TROUBLESHOOT YOUR CAMERA

PERFORM A STRESS TEST

Perform a stress test before important projects to ensure the reliability and stability of your gear. A stress test subjects your camera system and equipment to the increased stress of prolonged operation. If any components are developing issues, this test will help identify those problems before you have an equipment failure during a major shoot.

1. Configure your camera.
2. Calibrate the sensor. For more information, go to "[Sensor Calibration](#)" on page 159.
3. Enable the Sensor Test Pattern. For more information, go to "[Enable/Disable Sensor Test Pattern](#)" on page 155.
4. Select the desired resolution.
5. Select the highest available frame rate.
6. Perform a secure format of the SSD.
7. Record a full SSD of footage.
8. Perform a secure format of the SSD.
9. Repeat [Step 6](#) to [Step 8](#) to test multiple SSDs.
10. If any errors occur, save a log file and submit a Support ticket at <https://support.red.com>.

NOTE: Problems or dropped frames found during the stress test display as “Errors” in the bottom of the user interface.

GENERAL TROUBLESHOOTING

FIRMWARE DOES NOT UPGRADE

SYMPTOM

- ▶ During an attempt to upgrade firmware, the PWR and REC LEDs flash red.
- ▶ After an attempt to upgrade firmware, the firmware version does not change.

POTENTIAL RESOLUTIONS

- ▶ After downloading the firmware upgrade file, ensure that you unzip the file before saving it to the SSD.
- ▶ Ensure that the “force_upgrade” folder is saved to the top level of the SSD, and not to a subfolder.

DSMC2 MONSTRO OPERATION GUIDE

GENERAL: MODULE, EXPANDER, OR LENS MOUNT NOT FUNCTIONING

SYMPTOM

A module, expander, or lens mount is not functioning correctly, or is not communicating with the camera.

POTENTIAL RESOLUTIONS

- ▶ Perform a Hardware Rediscover. For more information, go to "[Rediscover \(Hardware Rediscover\)](#)" on page 156.
- ▶ Upgrade your camera firmware. For more information, go to "[Upgrade Camera Firmware](#)" on page 187.
- ▶ Reset your camera's default settings. For more information, go to "[Reset Defaults](#)" on page 156.

CAMERA DOES NOT RECOGNIZE LENS

SYMPTOM

The camera does not recognize the attached lens.

POTENTIAL RESOLUTIONS

- ▶ Ensure that the lens is compatible. For more information, go to "[Lenses](#)" on page 251.
- ▶ If using a PL lens, ensure that the camera is providing power to the lens: go to **Menu > Settings > Setup > Lens** and select the **Enable Power to Lens** check box.
- ▶ Detect the lens: go to **Menu > Settings > Setup > Lens** and select **Detect Lens**.
- ▶ Perform a Hardware Rediscover. For more information, go to "[Rediscover \(Hardware Rediscover\)](#)" on page 156.

CAMERA DISPLAYS N/A FOR APERTURE

SYMPTOM

The camera displays N/A for aperture when a lens is attached.

POTENTIAL RESOLUTIONS

- ▶ Ensure that your lens is completely locked in place.
- ▶ Remove your lens mount. Check the connection points for damage or debris. Install your lens mount.
- ▶ Perform a Hardware Rediscover. For more information, go to "[Rediscover \(Hardware Rediscover\)](#)" on page 156.
- ▶ Re-install your camera firmware.
- ▶ If your camera is on beta firmware, downgrade to the release build.
- ▶ If you are using a DSMC PL mount, go to **Menu > Settings > Setup > Lens** and ensure that power is enabled.

NOTE: Some lenses do not display the aperture information because they are incompatible. Some PL lenses do not have i-technology data.

CANNOT SEE MENUS ON LCD TOUCHSCREEN

SYMPTOM

The LCD touchscreen does not display menus.

POTENTIAL RESOLUTION

Double-tap the LCD touchscreen to exit Clean mode.

DSMC2 MONSTRO OPERATION GUIDE

SCREEN FREEZES OR DOES NOT DISPLAY

SYMPTOM

The screen freezes or does not display.

POTENTIAL RESOLUTION

Perform a Hard Restore. For more information, go to ["Perform a Hard Restore" on page 197](#).

INTERMITTENT MOTION JITTER

SYMPTOM

A slight, intermittent motion jitter displays on the monitor.

POTENTIAL RESOLUTIONS

If you calibrate the sensor using the Auto Calibration method, the calibration map updates in the background when camera settings change. The update may cause slight, intermittent motion jitter to the image on the monitor. The jitter characteristic only displays in live preview, and does not affect recorded footage. For more information on sensor calibration, go to ["Sensor Calibration" on page 159](#).

LCD FLICKER

SYMPTOM

The LCD or monitor is flickering.

POTENTIAL RESOLUTIONS

- ▶ Set the LCD frequency to 60 Hz. For more information, go to ["Frequency" on page 88](#).
- ▶ Use a different cable.
- ▶ Ensure cables are properly attached.

LCD BLANK AT STARTUP

SYMPTOM

When you turn on the camera, the LCD does not show any image.

POTENTIAL RESOLUTIONS

Turn off the camera. Wait at least three (3) seconds, and then turn the camera back on.

DSMC2 MONSTRO OPERATION GUIDE

CANNOT USE TOUCHSCREEN

SYMPTOM

Cannot control the camera via the touchscreen or the DSMC2® SIDEKICK™.

POTENTIAL RESOLUTIONS

- ▶ Perform a Hard Restore. For more information, go to "[Perform a Hard Restore](#)" on the next page.
- ▶ If you are using an external monitor, enable menus on the monitors and control the camera via the DSMC2 SIDEKICK:
 - ▶ Connect an SSD (RED MINI-MAG®) to your computer.
 - ▶ On the SSD, create a new folder, and name it **force_preset**.
 - ▶ Download the [DSMC Toolkit](#) from www.red.com/downloads.
 - ▶ Open the **Preset_Files** folder.
 - ▶ Open the folder that corresponds to the firmware version you are using.
 - ▶ Save the appropriate **enable_menus** file to the **force_preset** folder on your SSD.
 - ▶ Eject or unmount the SSD, and then remove the SSD.
 - ▶ Ensure that the camera is turned off.
 - ▶ Insert the SSD into your camera.
 - ▶ Turn on the camera. The camera automatically applies the preset.

NOTE: On Mac® computers with REDCINE-X PRO® installed, RED® Watchdog mounts the SSD as Read-Only by default, which means that you are unable to write files (including firmware upgrade files) to the SSD. Change the **Mount** preference to **Read-Write** before attempting to copy firmware to the SSD.

TIGHTEN DC IN CONNECTOR

SYMPTOM

The DC IN connector nut is loose.

POTENTIAL RESOLUTIONS

- ▶ Tighten the loose DC IN connector nut using a pair of heavy duty strong point tweezers.

WARNING: DO NOT OVERTIGHTEN.

- ▶ **Optional:** Add a small amount of Loctite® 222 (low strength thread locker) to the threads of the DC IN connector nut to prevent the connector from becoming loose again.

DSMC2 MONSTRO OPERATION GUIDE

CAMERA DOES NOT TURN ON

SYMPTOM

The camera does not turn on (does not boot up), even when powered.

POTENTIAL RESOLUTIONS

- ▶ Remove all accessories and power the camera using the power adaptor.
- ▶ Perform a Hard Restore. For more information, go to "[Perform a Hard Restore](#)" below.
- ▶ Remove all accessories and power the camera using the power adaptor.
- ▶ If the camera does not turn on when a battery is attached, but does turn on when DC power is attached, toggle the **Auto Boot on Power** switch to **Off** (identified by a black star).

PERFORM A HARD RESTORE

A common way to resolve camera firmware issues is to perform a Hard Restore. A Hard Restore functions like a System Restore in that it changes all settings to the factory default values.

To perform a Hard Restore, follow the instructions below:

1. With the camera turned off, hold the **PWR/REC** key on the camera for 20 seconds or until the fans turn at a high speed.
2. Release the **PWR/REC** key.
The screen displays correctly.

NOTE: User key settings reset as well as any other changes from the default settings.

IMAGE APPEARS GRAINY

SYMPTOM

Image or footage appears grainy.

POTENTIAL RESOLUTIONS

- ▶ Calibrate the sensor before recording additional clips. For more information, go to "[Sensor Calibration](#)" on [page 159](#).
- ▶ Check the histogram to ensure proper exposure. Noise occurs if an image is overexposed or underexposed.
- ▶ Use the lowest REDCODE® compression possible for the settings you have selected.
- ▶ Use a higher resolution.
- ▶ Use Adaptive fan mode to regulate the camera temperature. Noise occurs when the temperature from the applied calibration map is not in sync.

DSMC2 MONSTRO OPERATION GUIDE

BLACK AND WHITE IMAGE

SYMPTOM

The display shows that an image is in black and white, and the menus are still in color.

POTENTIAL RESOLUTIONS

- ▶ Check the Color Saturation setting. If the Saturation setting is set to a low value, change the Saturation to a higher value.
- ▶ Reset your camera's default settings. For more information, go to ["Reset Defaults" on page 156](#).

INCORRECT COLOR TEMPERATURE

SYMPTOM

The camera color temperature is off and the image looks warmer or cooler than normal.

POTENTIAL RESOLUTIONS

- ▶ Perform an auto white-balance. For more information, go to ["White Balance" on page 82](#).
- ▶ Calibrate the sensor. For more information, go to ["Sensor Calibration" on page 159](#).

TIMECODE OR GENLOCK DOES NOT FUNCTION

SYMPTOM

The SYNC, GEN, and/or TC light is red, yellow, or greyed out.

POTENTIAL RESOLUTIONS

- ▶ Ensure that your timecode or genlock device is compatible. For more information, go to ["Compatible Timecode Devices" on page 186](#) and ["Compatible Genlock Devices" on page 186](#).
- ▶ Use a different cable.
- ▶ Ensure that your timecode or genlock device settings match your project settings.
- ▶ Ensure that your timecode or genlock device is set to the correct source. For more information, go to ["Timecode" on page 172](#) and ["Genlock" on page 175](#).
- ▶ Ensure that your Sensor Sync Mode is set to **Genlock**. For more information, go to ["Sensor Sync" on page 176](#).
- ▶ Set the ACN (Ambient Clockit Network) to Off.

CAMERA DOES NOT RECOGNIZE OLPF

SYMPTOM

Your camera does not recognize the OLPF.

POTENTIAL RESOLUTIONS

- ▶ Reinstall the OLPF. For more information, go to ["Swap an Interchangeable OLPF" on page 53](#).
- ▶ Install a different OLPF.
- ▶ If your camera still does not recognize the OLPF, submit a [Technical Support](https://support.red.com) request at <https://support.red.com>.

DSMC2 MONSTRO OPERATION GUIDE

POSSIBLE HOT PIXEL

SYMPTOM

Your camera displays a possible hot pixel.

EXPLANATION

There may not be an issue with the pixel itself. The sensor can display a hot pixel when the sensor calibration is outdated. Current camera settings and temperature can affect pixel calibration.

POTENTIAL RESOLUTIONS

- ▶ Delete all user-generated calibration files and recalibrate the sensor. For more information, go to "[Sensor Calibration](#)" on page 159.
- ▶ Upgrade your camera firmware. For more information, go to "[Upgrade Camera Firmware](#)" on page 187.
- ▶ Reset your camera's default settings. For more information, go to "[Reset Defaults](#)" on page 156.
- ▶ Check your footage on a computer to confirm that the hot pixel is from the camera sensor, not your display monitor.
- ▶ If you determine that the camera sensor has a hot pixel, use the Pixel Masking tool in REDCINE-X PRO to remove the hot pixel until the issue gets resolved. For more information, see the [REDCINE-X PRO Operation Guide](#), available at www.red.com/downloads.

NO HDMI OR MON-1 SIGNAL

SYMPTOM

The HDMI or MON-1 port on the expander or module does not output a signal.

EXPLANATION

The secondary LCD/EVF port (on the side of the camera) and the HDMI/MON-1 port cannot be used at the same time. For more information, go to "[Monitor Preferences](#)" on page 87.

POTENTIAL RESOLUTIONS

- ▶ If an LCD or EVF is connected to the secondary LCD/EVF port (on the side of the camera), remove the LCD or EVF.
- ▶ Ensure that HDMI/HD-SDI monitoring/recording is set up correctly. For more information, go to "[Record](#)" on page 56.

DSMC2 MONSTRO OPERATION GUIDE

ERROR MESSAGES

“CRITICAL FAILURE” OR “SERIOUS ERROR” MESSAGES

SYMPTOM

When you upgrade or turn on the camera, the display shows a message with the phrase “Critical Failure” or “Serious Error”.

POTENTIAL RESOLUTIONS

- ▶ Update the camera firmware to the latest [release build](http://www.red.com/downloads) available for download at www.red.com/downloads.
- ▶ Submit a Support ticket at <https://support.red.com>. Include the following with the request:
 - ▶ Log file. For more information, go to ["Save a Log File" on page 154](#).
 - ▶ List of devices, lens, and third-party accessories that were attached when the error occurred.
 - ▶ Method for powering the camera when the error occurred (include battery types, power devices, and power cables).

"UPGRADE ATTACHED PERIPHERALS" MESSAGE

SYMPTOM

During an attempt to upgrade firmware, the display shows the message “Upgrade Attached Peripherals”. After turning the camera off and then on, the same message displays, and then prompts you to turn off the camera.

POTENTIAL RESOLUTION

- ▶ Ensure that you are upgrading your camera to the newest firmware version.
- ▶ One (1) of your modules, expanders, or lens mounts (collectively known as “peripherals”) may be experiencing issues. Remove all peripherals (except for media bay) and upgrade firmware. Then attach another peripheral, and upgrade firmware again. Repeat this process, upgrading one (1) peripheral at a time. This will identify which peripheral is experiencing issues. If there is a peripheral that will not upgrade, submit a Support ticket at <https://support.red.com>.

PRESET COULD NOT BE APPLIED

SYMPTOM

The display shows the following message: “Preset Could Not Be Applied”.

POTENTIAL RESOLUTION

Turn off the camera, power it back up, and attempt to apply the preset that failed.

CANNOT CONTROL CAMERA EXTERNALLY

SYMPTOM

The camera displays the message “For reliable external control over Ethernet your camera’s hardware may need to be upgraded. Please contact your Bomb Squad representative”.

POTENTIAL RESOLUTIONS

If you see this message, submit a Support ticket at <https://support.red.com> to have your hardware upgraded. You will not be able to control the camera externally until the hardware is upgraded.

DSMC2 MONSTRO OPERATION GUIDE

ERROR 0X00000020 OR ERROR 0X20

SYMPTOM

The display shows one of the following messages:

- ▶ Error 0x00000020. Please save log and send to RED Support.
- ▶ ERROR 0x20. Media integrity error. Please secure format the SSD. If the issue persists, save log file and contact RED Support with the log file, method of powering camera, and camera configuration.

POTENTIAL RESOLUTIONS

- ▶ Perform a secure format of the SSD. For more information, see the [DSMC Media Operation Guide](#), available at www.red.com/downloads.
- ▶ Update the camera firmware to the latest [release build](#) available for download at www.red.com/downloads.
- ▶ Submit a Support ticket at <https://support.red.com>. Include the following with the request:
 - ▶ Log file. For more information, go to "[Save a Log File](#)" on page 154.
 - ▶ List of devices, lens, and third-party accessories that were attached when the error occurred.
 - ▶ Method for powering the camera when the error occurred (include battery types, power devices, and power cables).

ERROR 0X01D

SYMPTOM

The display shows the following message: "ERROR 0x01D. Possible hardware error. Please save log file and contact RED Support with the log file and camera configuration."

POTENTIAL RESOLUTIONS

Submit a Support ticket at <https://support.red.com>. Include the following with the request:

- ▶ Log file. For more information, go to "[Save a Log File](#)" on page 154.
- ▶ List of devices, lens, and third-party accessories that were attached when the error occurred.
- ▶ Method for powering the camera when the error occurred (include battery types, power devices, and power cables).

DSMC2 MONSTRO OPERATION GUIDE

ERROR 0X11D

SYMPTOM

The display shows the following message: "Media integrity error. Please secure format the SSD. If the issue persists, save log file and contact RED Support with the log file, method of powering camera, and camera configuration."

POTENTIAL RESOLUTIONS

- ▶ Perform a secure format of the SSD. For more information, see the [DSMC Media Operation Guide](#), available at www.red.com/downloads.
- ▶ Update the camera firmware to the latest [release build](#) available for download at www.red.com/downloads.
- ▶ Submit a Support ticket at <https://support.red.com>. Include the following with the request:
 - ▶ Log file. For more information, go to "[Save a Log File](#)" on [page 154](#).
 - ▶ List of devices, lens, and third-party accessories that were attached when the error occurred.
 - ▶ Method for powering the camera when the error occurred (include battery types, power devices, and power cables).

CAMERA KEEPS PROMPTING BLACK SHADE MESSAGE

SYMPTOM

Your camera keeps prompting you to black shade the camera.

POTENTIAL RESOLUTIONS

- ▶ Ensure that you complete the sensor calibration process. For more information, go to "[Sensor Calibration](#)" on [page 159](#).
- ▶ Go to **Menu > Settings > Maintenance > Calibrate** and select **user1 Calibration Map**. Click **Set**.
- ▶ Go to **Menu > Settings > Maintenance > Calibrate** and delete all user-created calibration maps. Then reset your camera's default settings. For more information, go to "[Reset Defaults](#)" on [page 156](#).

MOUNT TYPE: UNKNOWN

SYMPTOM

The error message "Mount type: Unknown" displays in **Menu > Settings > Setup > Lens**.

POTENTIAL RESOLUTIONS

- ▶ Ensure that a lens mount is installed.
- ▶ Ensure that a compatible lens mount is installed.

NOTE: Third-party lens mounts are not compatible with the camera.

DSMC2 MONSTRO OPERATION GUIDE

AUDIO BUFFER OVERFLOW WARNING

SYMPTOM

The error message "Audio Buffer Overflow" displays.

POTENTIAL RESOLUTIONS

- ▶ Update the camera firmware to the latest **release build** available for download at www.red.com/downloads.
- ▶ Perform a secure format of the SSD. For more information, see the **DSMC Media Operation Guide**, available at www.red.com/downloads.

IMPORTANT: Ensure that data is backed up before formatting the media, since formatting erases all data on the SSD.

- ▶ Submit a Support ticket at <https://support.red.com>. Include the following with the request:
 - ▶ Log file. For more information, go to **"Save a Log File" on page 154**.
 - ▶ List of devices, lens, and third-party accessories that were attached when the error occurred.
 - ▶ Method for powering the camera when the error occurred (include battery types, power devices, and power cables).
 - ▶ List of file formats you were recording to before the error occurred (R3D, Apple ProRes, Avid DNxHD/HR).

PROXY BUFFER OVERFLOW WARNING

SYMPTOM

The error message "Proxy Buffer Overflow" displays.

POTENTIAL RESOLUTIONS

- ▶ Update the camera firmware to the latest **release build** available for download at www.red.com/downloads.
- ▶ Select a different recording file format and/or resolution from the Codec menu. For more information, go to **"Select Record File Format" on page 133**
- ▶ Submit a Support ticket at <https://support.red.com>. Include the following with the request:
 - ▶ Log file. For more information, go to **"Save a Log File" on page 154**.
 - ▶ List of devices, lens, and third-party accessories that were attached when the error occurred.
 - ▶ Method for powering the camera when the error occurred (include battery types, power devices, and power cables).
 - ▶ List of file formats you were recording to before the error occurred (R3D, Apple ProRes, Avid DNxHD/HR).

DSMC2 MONSTRO OPERATION GUIDE

MEDIA BAY AND RED MINI-MAG ISSUES

SYMPTOMS

- ▶ LEDs on media bay do not illuminate when expected.
- ▶ RED MINI-MAG does not mount to camera.

POTENTIAL RESOLUTIONS

- ▶ Ensure RED MINI-MAG is fully inserted in the media bay.
- ▶ Perform a system restore.
- ▶ Reformat the RED MINI-MAG on the computer. For more information, see the [DSMC Media Operation Guide](http://www.red.com/downloads) at www.red.com/downloads.
- ▶ Remove and reinstall the media bay. For more information, go to "[Remove the Media Bay](#)" below.

REMOVE THE MEDIA BAY

To troubleshoot issues with the media bay or SSD, you may need to remove and re-install the media bay. Unless you are troubleshooting media-related issues, DO NOT remove the media bay.

WARNING: Before installing or removing the media bay, you MUST turn off the camera.

REQUIRED TOOL(S): T10 TORX driver

1. Turn off the camera.
2. Loosen the four (4) captive screws in a cross pattern ("X" pattern) using a T10 TORX driver.
3. Remove the media bay from the camera.
4. Inspect the connections and pins on the camera and ensure that they are clean and undamaged.
NOTE: DO NOT touch any part of the exposed boards or connectors.
5. Re-attach the media bay as soon as possible to prevent dust or debris from entering the camera. For more information, go to "[Install the Media Bay](#)" below.

INSTALL THE MEDIA BAY

WARNING: Before installing or removing the media bay, you MUST turn off the camera.

REQUIRED TOOL(S): T10 TORX driver

1. Turn off the camera.
2. Place the media bay on the camera, so that the mounting holes of the media bay align with the screw holes of the camera.
3. Use a T10 TORX driver to tighten the four (4) captive screws by about two (2) turns in a cross pattern ("X" pattern). DO NOT FULLY TIGHTEN.
4. Tighten the four (4) captive screws evenly. DO NOT exceed 70 in-oz, or damage may occur.

WARNING: DO NOT OVERTIGHTEN.

DSMC2 MONSTRO OPERATION GUIDE

BACK FOCUS LOCK (LOCK SENSOR)

The camera has a Back Focus lock, which locks the sensor in place to prevent it from moving. Locking the sensor is different from checking back focus.

To lock the sensor, follow the instructions below:

REQUIRED TOOL(S): T10 TORX driver, T8 TORX driver

WARNING: DO NOT adjust back focus when the sensor is locked in place by the Back Focus Lock, since that can damage the Sensor Positioning System. Damage to the camera system caused by adjusting the back focus while the sensor is locked is not covered under warranty.

1. Turn off the camera.
2. Use a T10 TORX driver to remove the side module (or side panel). For more information, go to "[Configure Your Camera](#)" on page 47.



Figure: Remove the Side Module/Panel

3. Use a T8 TORX driver to remove the screw from the Store Lock Screw position.



Figure: Remove Screw from Store Lock Screw Position

DSMC2 MONSTRO OPERATION GUIDE

4. Use a T8 TORX driver to install the screw in the Back Focus Lock position. DO NOT exceed 80 in-oz, or damage may occur.

WARNING: DO NOT OVERTIGHTEN.



Figure: Back Focus Successfully Locked

5. Reinstall the side module (or side panel). For more information, go to ["Configure Your Camera"](#) on page 47.



Figure: Reinstall the Side Module/Panel

APPENDIX A:

TECHNICAL SPECIFICATIONS

DSMC2 MONSTRO TECHNICAL SPECIFICATIONS

DSMC2 MONSTRO

SPECIFICATION	DESCRIPTION
Sensor Type	MONSTRO® 35.4 Megapixel CMOS
Effective Pixels	8192 x 4320
Sensor Size	40.96 mm x 21.60 mm (Diagonal: 46.31 mm)
Dynamic Range	17+ stops
Max Data Rates	Up to 300 MB/s using RED MINI-MAG® (480GB, 512GB, 960GB & 1TB) Up to 225 MB/s using RED MINI-MAG (120GB & 240GB)
Max Frame Rates ¹	60 fps at 8K Full Format (8192 x 4320), 75 fps at 8K 2.4:1 (8192 x 3456) 60 fps at 7K Full Format (7168 x 3780), 75 fps at 7K 2.4:1 (7168 x 3024) 75 fps at 6K Full Format (6144 x 3240), 100 fps at 6K 2.4:1 (6144 x 2592) 96 fps at 5K Full Format (5120 x 2700), 120 fps at 5K 2.4:1 (5120 x 2160) 120 fps at 4K Full Format (4096 x 2160), 150 fps at 4K 2.4:1 (4096 x 1728) 150 fps at 3K Full Format (3072 x 1620), 200 fps at 3K 2.4:1 (3072 x 1296) 240 fps at 2K Full Format (2048 x 1080), 300 fps at 2K 2.4:1 (2048 x 864)
Playback Frame Rates (Project Time Base)	23.98, 24, 25, 29.97, 30, 47.95, 48, 50, 59.94, 60 fps, all resolutions
REDCODE Settings Range from 2:1 to 22:1 ¹	5:1 REDCODE at 8K Full Format (8192 x 4320) and 24 fps 12:1 REDCODE at 8K Full Format (8192 x 4320) and 60 fps 2:1 REDCODE at 4K Full Format (4096 x 2160) and 24 fps 3:1 REDCODE at 4K Full Format (4096 x 2160) and 60 fps
REDCODE RAW Acquisition Formats ²	8K Full Format (8192 x 4320), 2:1, 2.4:1, 16:9, 14:9, 8:9, 3:2, 6:5, 4:1, 8:1, and Ana 2x, 1.3x, 1.25x 7K Full Format (7168 x 3780), 2:1, 2.4:1, 16:9, 8:9, 6:5, 4:1, 8:1, and Ana 2x, 1.3x 6K Full Format (6144 x 3240), 2:1, 2.4:1, 16:9, 8:9, 3:2, 4:3, 6:5, 4:1, 8:1, and Ana 2x, 1.3x, 1.25x 5K Full Format (5120 x 2700), 2:1, 2.4:1, 16:9, 8:9, 4:3, 6:5, 4:1, 8:1, and Ana 2x, 1.3x 4K Full Format (4096 x 2160), 2:1, 2.4:1, 16:9, 8:9, 3:2, 4:3, 5:4, 6:5, 4:1, 8:1, 1:1, and Ana 2x, 1.3x 3K Full Format (3072 x 1620), 2:1, 2.4:1, 16:9, 3:2, 4:3, 5:4, 6:5, 4:1, 8:1, and Ana 2x, 1.3x 2K Full Format (2048 x 1080), 2:1, 2.4:1, 16:9, 3:2, 4:3, 5:4, 6:5, 4:1, 8:1, and Ana 2x, 1.3x

DSMC2 MONSTRO OPERATION GUIDE

DSMC2 MONSTRO

SPECIFICATION	DESCRIPTION
Apple® ProRes	ProRes 422 HQ, ProRes 422 and ProRes 422 LT at 4K (4096 × 2160) up to 30 fps ProRes 4444 XQ and ProRes 4444 at 2K (2048 × 1080) up to 120 fps ProRes 422 HQ, ProRes 422 and ProRes 422 LT at 2K (2048 × 1080) up to 120 fps
Avid® Codecs	DNxHR HQX at 4K (4096 × 2160) 12-bit up to 30 fps DNxHR HQ and SQ at 4K (4096 × 2160) 8-bit up to 30 fps DNxHR 444 at 2K (2048 × 1080) 12-bit up to 120 fps DNxHR HQ and SQ at 2K (2048 × 1080) 8-bit up to 120 fps DNxHD 444 and HQX (1920 × 1080) 10-bit up to 120 fps DNxHD HQ and SQ (1920 × 1080) 8-bit up to 120 fps
Construction	Aluminum Alloy
Weight	3.35 lbs (BRAIN® with Integrated Media Bay)
Operating Temperature	0°C to 40°C (32°F to 104°F)
Storage Temperature	-20°C to 50°C (-4°F to 122°F)
Relative Humidity	0% to 85% non-condensing
Color Management	Supports 33×33×33, 32×32×32, 26×26×26, and 17×17×17 3D LUTs Variable number of 3D LUT outputs with DSMC2® expander module User programmable shaper 1D LUTs Tetrahedral interpolation, 16-bit processing
Audio	Integrated dual channel digital stereo microphones, uncompressed, 24-bit 48 kHz Optional 2 additional channels with DSMC2 expander module, uncompressed, 24-bit 48 kHz
Remote Control	Integrated R.C.P.™ WiFi antenna Ethernet, RS232, and GPI Trigger with DSMC2 expander module
Monitor Outputs	3G-SDI (HD-SDI) and HDMI with DSMC2 expander module 1080p RGB or 4:2:2, 720p RGB or 4:2:2 480p RGB or 4:2:2 (HDMI only) SMPTE Timecode, HANC Metadata, 24-bit 48 kHz Audio
Monitor Options	DSMC2 Touch 7.0" Ultra-Brite LCD (Direct Mount), DSMC2 RED® Touch 4.7" LCD, DSMC2 RED Touch 7.0" LCD, and DSMC2 RED EVF (OLED) with cable-free connection. RED Touch 9.0" LCD, RED Touch 7.0" LCD, RED Touch 5.0" LCD, RED PRO 7" LCD, DSMC2 Touch 7.0" Ultra-Brite LCD, BOMB EVF (OLED) and BOMB EVF (LCOS) compatible with DSMC2 LCD/EVF Adaptor A or DSMC2 LCD/EVF Adaptor D, and LCD/EVF cable.

DSMC2 MONSTRO OPERATION GUIDE

DSMC2 MONSTRO

SPECIFICATION	DESCRIPTION
REDCINE-X PRO Delivery Formats	4K: DPX, TIFF, OpenEXR (.RED via RREncode plugin) 2K: DPX, TIFF, OpenEXR (.RED via RREncode plugin) 1080p RGB 4:2:2, 720p 4:2:2 : QuickTime®, JPEG, Avid AAF, MXF 1080p 4:2:0, 720p 4:2:0 : H.264, .MP4
Video Editing Software Compatibility ³	Adobe® Premiere® Pro, Avid Media Composer®, DaVinci Resolve®, Edius Pro®, Final Cut Pro®, Vegas Pro®

1. REDCODE values and max frame rates may vary based on selected acquisition format, aspect ratio, project time base, Look Around setting, and SSD. For more information, see the [DSMC Media Operation Guide](http://www.red.com/downloads) at www.red.com/downloads.
2. For more information on available acquisition formats, see the [DSMC Media Operation Guide](http://www.red.com/downloads) at www.red.com/downloads.
3. Third-party non-linear editing (NLE) applications may have limited compatibility with R3D files.

DSMC2 MONSTRO OPERATION GUIDE

DSMC2 MONSTRO MONOCHROME TECHNICAL SPECIFICATIONS

DSMC2 MONSTRO MONOCHROME

SPECIFICATION	DESCRIPTION
Sensor Type	MONSTRO Monochrome 35.4 Megapixel CMOS
Effective Pixels	8192 x 4320
Sensor Size	40.96 mm x 21.60 mm (Diagonal: 46.31 mm)
Dynamic Range	17+ stops
Max Data Rates	Up to 300 MB/s using RED MINI-MAG (480GB, 512GB, 960GB & 1TB) Up to 225 MB/s using RED MINI-MAG (120GB & 240GB)
Max Frame Rates ¹	60 fps at 8K Full Format (8192 x 4320), 75 fps at 8K 2.4:1 (8192 x 3456) 60 fps at 7K Full Format (7168 x 3780), 75 fps at 7K 2.4:1 (7168 x 3024) 75 fps at 6K Full Format (6144 x 3240), 100 fps at 6K 2.4:1 (6144 x 2592) 96 fps at 5K Full Format (5120 x 2700), 120 fps at 5K 2.4:1 (5120 x 2160) 120 fps at 4K Full Format (4096 x 2160), 150 fps at 4K 2.4:1 (4096 x 1728) 150 fps at 3K Full Format (3072 x 1620), 200 fps at 3K 2.4:1 (3072 x 1296) 240 fps at 2K Full Format (2048 x 1080), 300 fps at 2K 2.4:1 (2048 x 864)
Playback Frame Rates (Project Time Base)	23.98, 24, 25, 29.97, 30, 47.95, 48, 50, 59.94, 60 fps, all resolutions
REDCODE Settings Range from 2:1 to 22:1 ¹	5:1 REDCODE at 8K Full Format (8192 x 4320) and 24 fps 12:1 REDCODE at 8K Full Format (8192 x 4320) and 60 fps 2:1 REDCODE at 4K Full Format (4096 x 2160) and 24 fps 3:1 REDCODE at 4K Full Format (4096 x 2160) and 60 fps
REDCODE RAW Acquisition Formats ²	8K Full Format (8192 x 4320), 2:1, 2.4:1, 16:9, 14:9, 8:9, 3:2, 6:5, 4:1, 8:1, and Ana 2x, 1.3x, 1.25x 7K Full Format (7168 x 3780), 2:1, 2.4:1, 16:9, 8:9, 6:5, 4:1, 8:1, and Ana 2x, 1.3x 6K Full Format (6144 x 3240), 2:1, 2.4:1, 16:9, 8:9, 3:2, 4:3, 6:5, 4:1, 8:1, and Ana 2x, 1.3x, 1.25x 5K Full Format (5120 x 2700), 2:1, 2.4:1, 16:9, 8:9, 4:3, 6:5, 4:1, 8:1, and Ana 2x, 1.3x 4K Full Format (4096 x 2160), 2:1, 2.4:1, 16:9, 8:9, 3:2, 4:3, 5:4, 6:5, 4:1, 8:1, 1:1, and Ana 2x, 1.3x 3K Full Format (3072 x 1620), 2:1, 2.4:1, 16:9, 3:2, 4:3, 5:4, 6:5, 4:1, 8:1, and Ana 2x, 1.3x 2K Full Format (2048 x 1080), 2:1, 2.4:1, 16:9, 3:2, 4:3, 5:4, 6:5, 4:1, 8:1, and Ana 2x, 1.3x
Apple® ProRes	ProRes 422 HQ, ProRes 422 and ProRes 422 LT at 4K (4096 x 2160) up to 30 fps ProRes 4444 XQ and ProRes 4444 at 2K (2048 x 1080) up to 120 fps ProRes 422 HQ, ProRes 422 and ProRes 422 LT at 2K (2048 x 1080) up to 120 fps

DSMC2 MONSTRO OPERATION GUIDE

DSMC2 MONSTRO MONOCHROME

SPECIFICATION	DESCRIPTION
Avid® Codecs	DNxHR HQX at 4K (4096 × 2160) 12-bit up to 30 fps DNxHR HQ and SQ at 4K (4096 × 2160) 8-bit up to 30 fps DNxHR 444 at 2K (2048 × 1080) 12-bit up to 120 fps DNxHR HQ and SQ at 2K (2048 × 1080) 8-bit up to 120 fps DNxHD 444 and HQX (1920 × 1080) 10-bit up to 120 fps DNxHD HQ and SQ (1920 × 1080) 8-bit up to 120 fps
Construction	Aluminum Alloy
Weight	3.35 lbs (BRAIN with Integrated Media Bay)
Operating Temperature	0°C to 40°C (32°F to 104°F)
Storage Temperature	-20°C to 50°C (-4°F to 122°F)
Relative Humidity	0% to 85% non-condensing
Color Management	Supports 33×33×33, 32×32×32, 26×26×26, and 17×17×17 3D LUTs Variable number of 3D LUT outputs with DSMC2 expander module User programmable shaper 1D LUTs Tetrahedral interpolation, 16-bit processing
Audio	Integrated dual channel digital stereo microphones, uncompressed, 24-bit 48 kHz Optional 2 additional channels with DSMC2 expander module, uncompressed, 24-bit 48 kHz
Remote Control	Integrated R.C.P. WiFi antenna Ethernet, RS232, and GPI Trigger with DSMC2 expander module
Monitor Outputs	3G-SDI (HD-SDI) and HDMI with DSMC2 expander module 1080p RGB or 4:2:2, 720p RGB or 4:2:2 480p RGB or 4:2:2 (HDMI only) SMPTE Timecode, HANC Metadata, 24-bit 48 kHz Audio
Monitor Options	DSMC2 Touch 7.0" Ultra-Brite LCD (Direct Mount), DSMC2 RED® Touch 4.7" LCD, DSMC2 RED Touch 7.0" LCD, and DSMC2 RED EVF (OLED) with cable-free connection. RED Touch 9.0" LCD, RED Touch 7.0" LCD, RED Touch 5.0" LCD, RED PRO 7" LCD, DSMC2 Touch 7.0" Ultra-Brite LCD, BOMB EVF (OLED) and BOMB EVF (LCOS) compatible with DSMC2 LCD/EVF Adaptor A or DSMC2 LCD/EVF Adaptor D, and LCD/EVF cable.
REDCINE-X PRO Delivery Formats	4K: DPX, TIFF, OpenEXR (.RED via REncode plugin) 2K: DPX, TIFF, OpenEXR (.RED via REncode plugin) 1080p RGB 4:2:2, 720p 4:2:2 : QuickTime, JPEG, Avid AAF, MXF 1080p 4:2:0, 720p 4:2:0 : H.264, .MP4

DSMC2 MONSTRO OPERATION GUIDE

DSMC2 MONSTRO MONOCHROME

SPECIFICATION	DESCRIPTION
---------------	-------------

Video Editing Software Compatibility ³	Adobe Premiere Pro, Avid Media Composer, DaVinci Resolve, Edius Pro, Final Cut Pro, Vegas Pro
---	---

1. REDCODE values and max frame rates may vary based on selected acquisition format, aspect ratio, project time base, Look Around setting, and SSD. For more information, see the [DSMC Media Operation Guide](http://www.red.com/downloads) at www.red.com/downloads.
2. For more information on available acquisition formats, see the [DSMC Media Operation Guide](http://www.red.com/downloads) at www.red.com/downloads.
3. Third-party non-linear editing (NLE) applications may have limited compatibility with R3D files.

APPENDIX B: MECHANICAL DRAWINGS

DSMC2 MONSTRO

NOTE: Dimensions are shown in mm.

The optical axis height of the camera is 95.90 mm.

FRONT VIEW

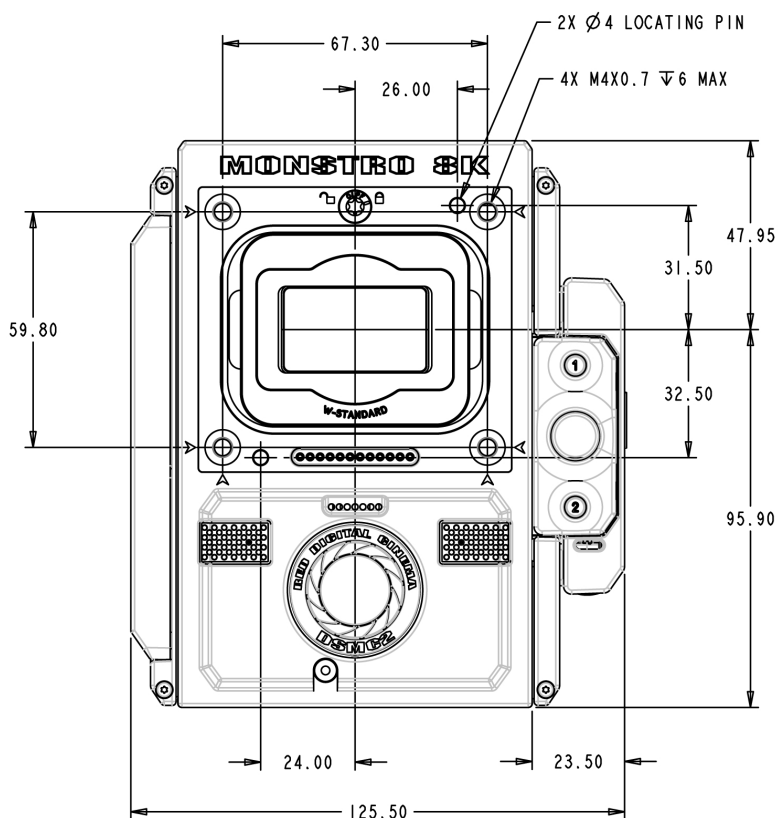

Figure: Camera Front View

DSMC2 MONSTRO OPERATION GUIDE

BACK VIEW

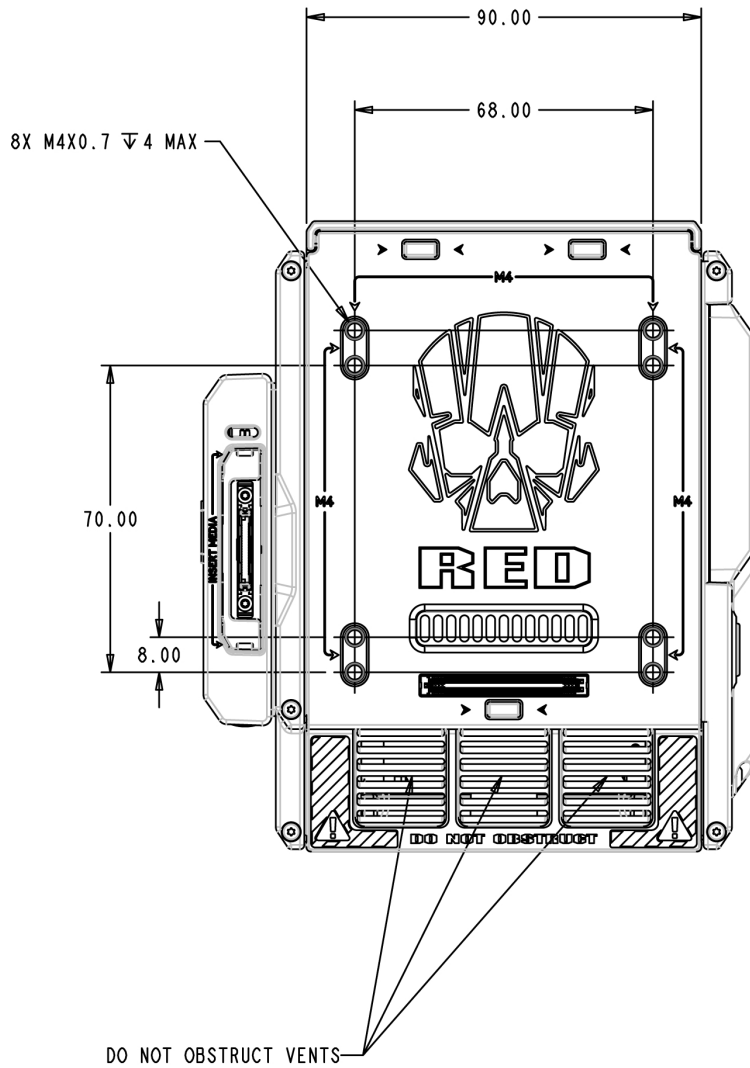

Figure: Camera Back View

DSMC2 MONSTRO OPERATION GUIDE

SIDE VIEW (RIGHT)

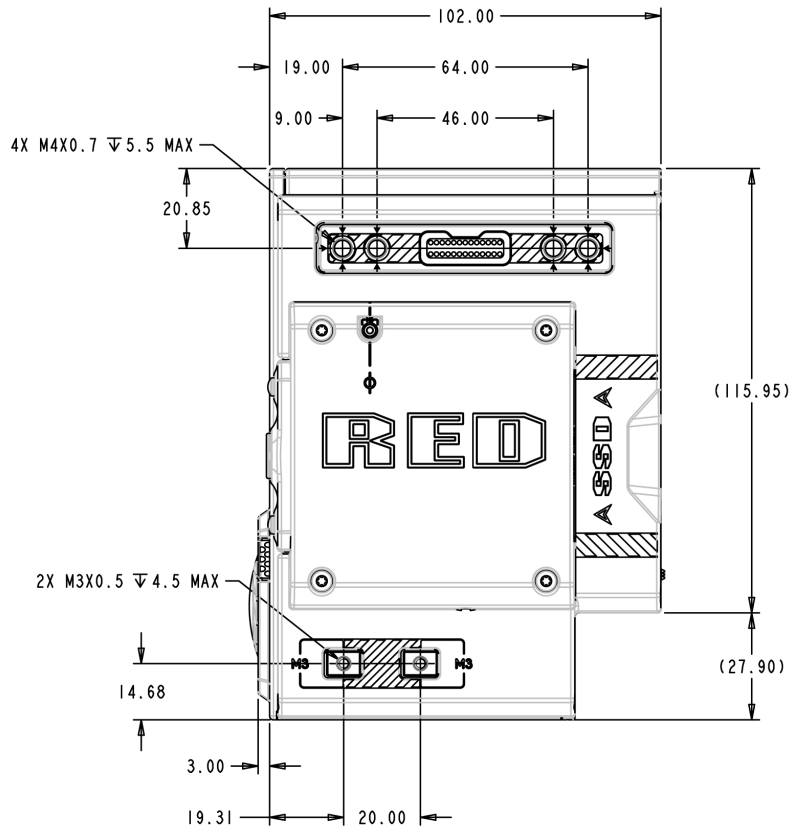

Figure: Camera Side View (Right)

DSMC2 MONSTRO OPERATION GUIDE

SIDE VIEW (LEFT)

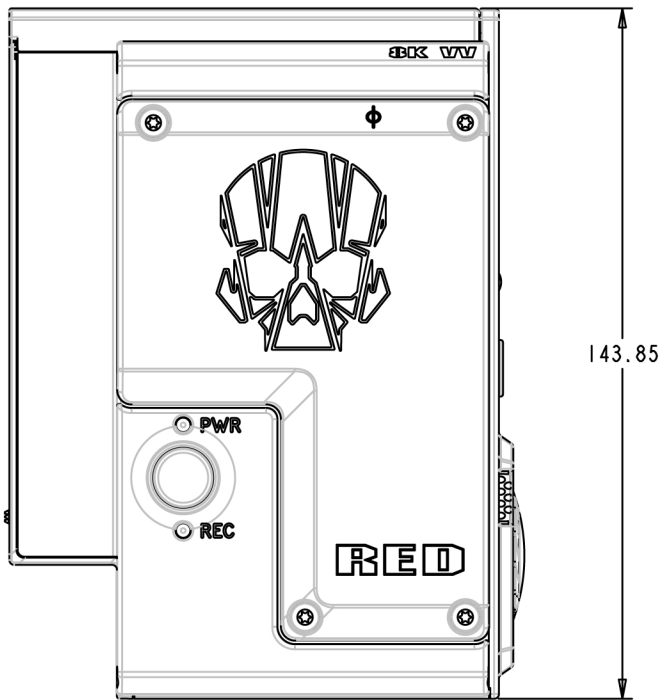

Figure: Camera Side View (Left)

DSMC2 MONSTRO OPERATION GUIDE

TOP VIEW

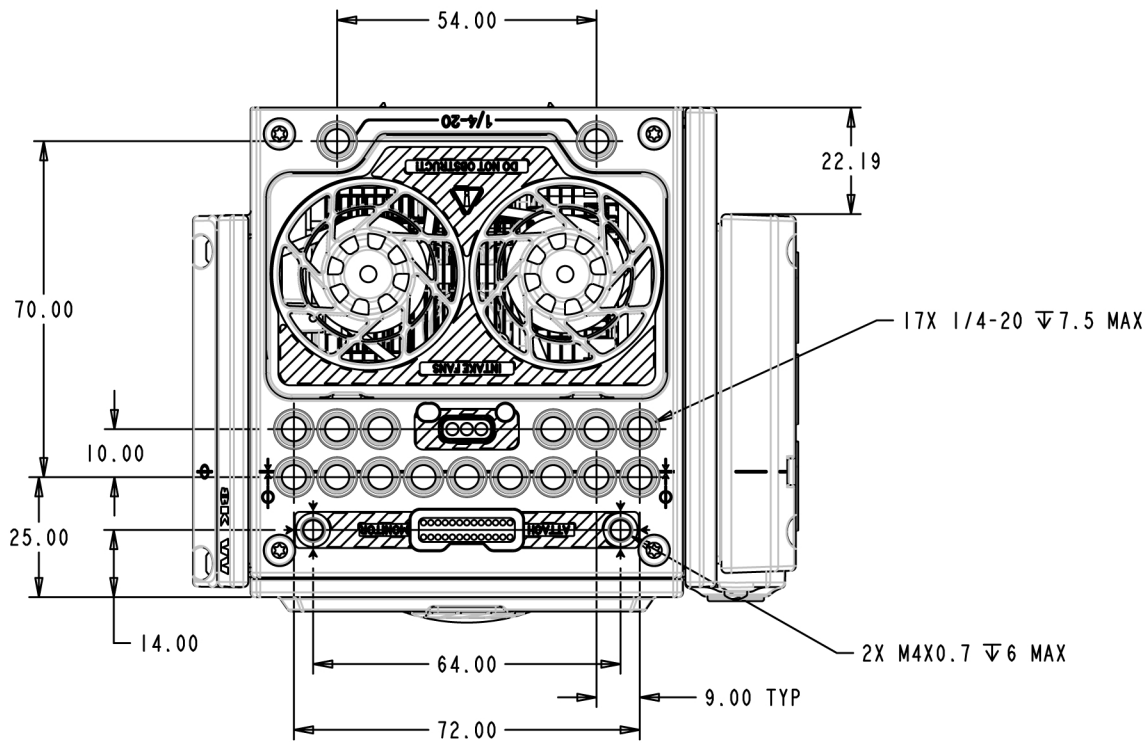

Figure: Camera Top View

BOTTOM VIEW

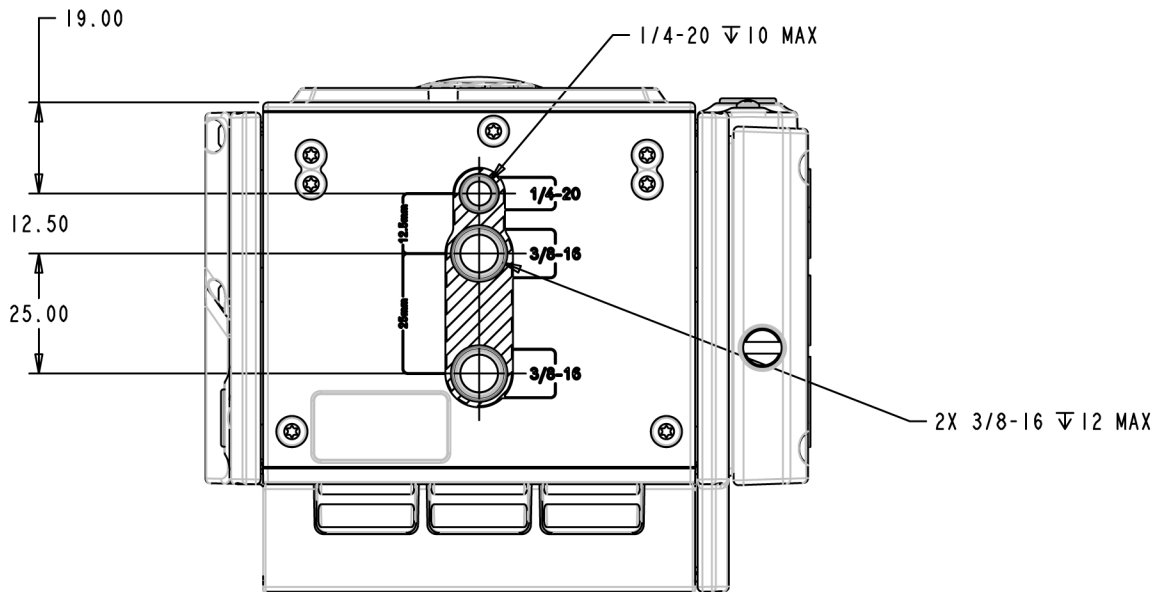

Figure: Camera Bottom View

APPENDIX C:

INPUT/OUTPUT CONNECTORS

This appendix provides pinout information for the input/output connectors on the following components:

- ▶ DSMC2® Base Expander
- ▶ DSMC2 V-Lock I/O Expander
- ▶ DSMC2 REDVOLT Expander
- ▶ DSMC2 Jetpack Expander
- ▶ DSMC2 Jetpack-SDI Expander
- ▶ DSMC2 Production Module
- ▶ DSMC2 Tactical Top Plate
- ▶ DSMC2 Production Top Plate

NOTE: When connecting a cable to a connector, align the key and red marker on the cable connector with the corresponding key and marker on the device connection.

NOTE: Connector diagram images are for reference only. Diagrams are not to scale.

DSMC2 MONSTRO OPERATION GUIDE

DSMC2 BASE EXPANDER

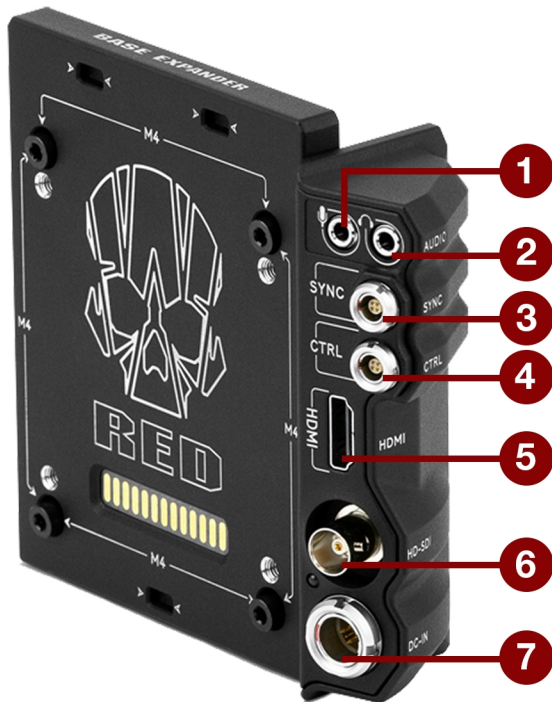

Figure: DSMC2 Base Expander

#	CONNECTOR	CONNECTOR TYPE	DETAILS
1	Stereo Microphone	3.5mm stereo	"Stereo Microphone" on page 240
2	Headphone Jack	3.5mm stereo	"Headphone" on page 241
3	SYNC	4-pin 00B	"SYNC (Video Sync In) with SYNC Trigger Button Circuit" on page 229
4	CTRL	4-pin 00B	"CTRL (RS232 Control)" on page 233
5	HDMI®	HDMI 1.2, Type A	"HDMI Out" on page 228
6	HD-SDI	BNC	"3G-SDI (HD-SDI) Out" on page 226
7	DC IN	6-pin 1B DC-IN	"DC IN (Power Input)" on page 242

DSMC2 MONSTRO OPERATION GUIDE

DSMC2 V-LOCK I/O EXPANDER

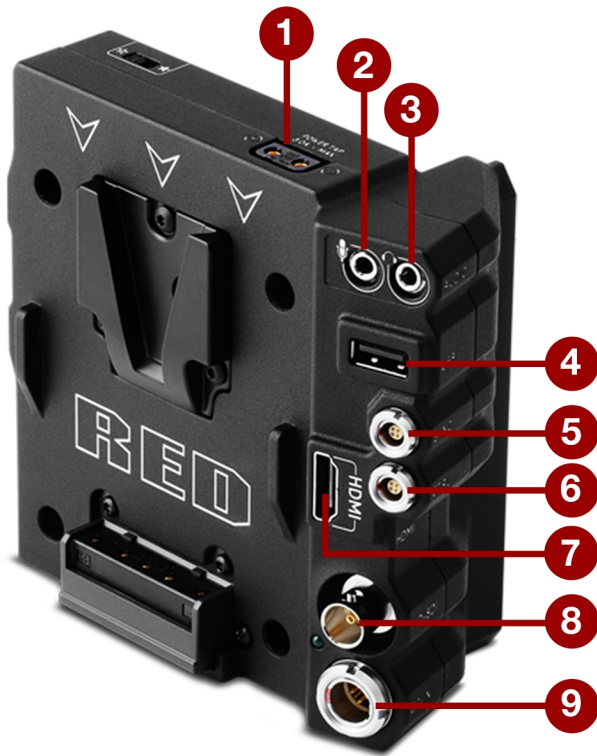

Figure: DSMC2 V-Lock I/O Expander

#	CONNECTOR	CONNECTOR TYPE	DETAILS
1	AUX Power	P-Tap 2-pin Female	"AUX Power (P-Tap)" on page 246
2	Stereo Microphone	3.5mm stereo	"Stereo Microphone" on page 240
3	Headphone Jack	3.5mm stereo	"Headphone" on page 241
4	USB Power	USB 2.0, Type A (power only)	"USB Power" on page 245
5	SYNC	4-pin 00B	"SYNC (Video Sync In) with Contact Closure Style Trigger Input" on page 231
6	CTRL	4-pin 00B	"CTRL (RS232 Control)" on page 233
7	HDMI®	HDMI 1.2, Type A	"HDMI Out" on page 228
8	HD-SDI	BNC	"3G-SDI (HD-SDI) Out" on page 226
9	DC IN	6-pin 1B DC-IN	"DC IN (Power Input)" on page 242

DSMC2 MONSTRO OPERATION GUIDE

DSMC2 REDVOLT EXPANDER

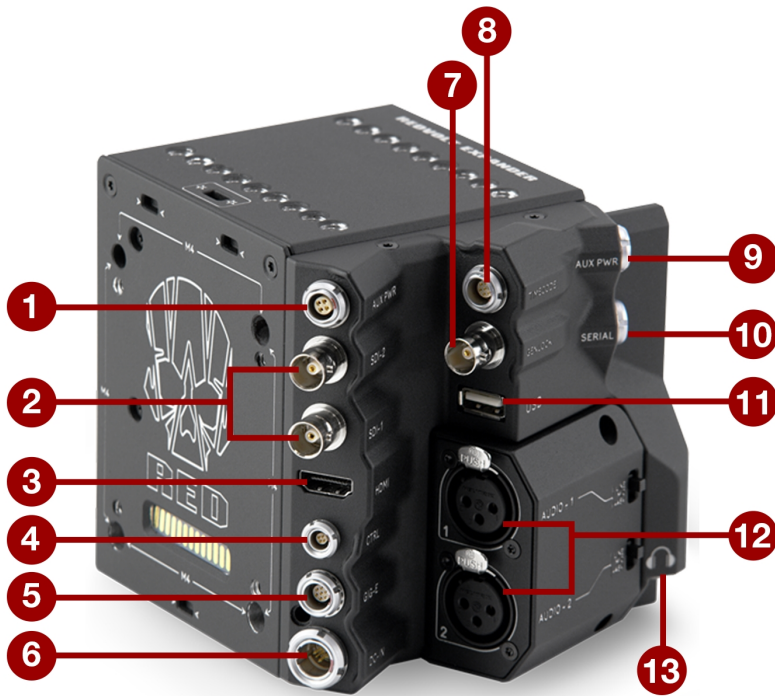

Figure: DSMC2 REDVOLT Expander

#	CONNECTOR	CONNECTOR TYPE	DETAILS
1	AUX PWR	4-Pin 0B	"AUX Power (4-Pin 0B)" on page 245
2	SDI 1 and 2	BNC	"3G-SDI (HD-SDI) Out" on page 226
3	HDMI	HDMI 1.2, Type A	"HDMI Out" on page 228
4	CTRL	4-pin 00B	"CTRL (RS232 Control)" on page 233
5	GIG-E	9-pin 0B	"GIG-E (Ethernet)" on page 237
6	DC IN	6-pin 1B DC-IN	"DC IN (Power Input)" on page 242
7	GENLOCK	BNC	"Genlock" on page 235
8	TIMECODE	5-Pin 0B	"Timecode" on page 236
9	AUX PWR	2-Pin 0B	"AUX Power 2-Pin 0B, 3.0A" on page 243
10	SERIAL	7-pin 0B	"Serial (RS232 Control)" on page 234
11	USB	USB 2.0 Type A (power only)	"USB Power" on page 245
12	AUDIO 1 and 2	3-pin full-size XLR	"Audio 1 and 2" on page 240
13	Headphone Jack	3.5mm stereo	"Headphone" on page 241

DSMC2 MONSTRO OPERATION GUIDE

DSMC2 JETPACK EXPANDER

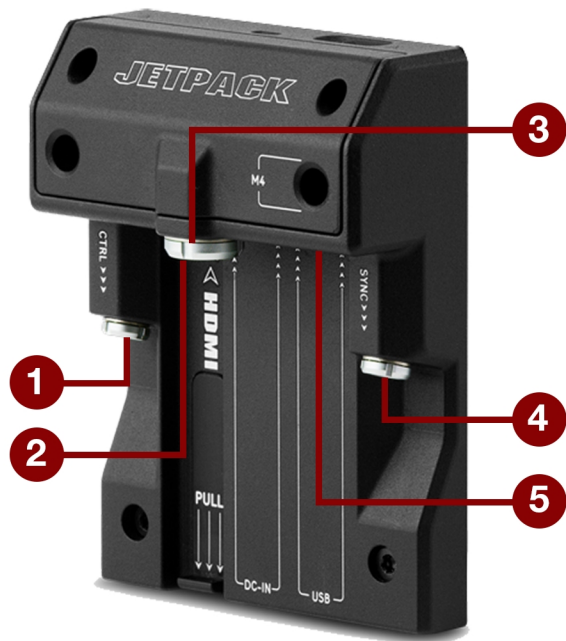

Figure: DSMC2 Jetpack Expander

#	CONNECTOR	CONNECTOR TYPE	DETAILS
1	CTRL	4-pin 00B	"CTRL (RS232 Control)" on page 233
2	HDMI	HDMI 1.2, Type A	"HDMI Out" on page 228
3	DC IN	6-pin 1B DC-IN	"DC IN (Power Input)" on page 242
4	SYNC	4-pin 00B	"SYNC (Video Sync In) with Contact Closure Style Trigger Input" on page 231
5	USB	USB 2.0, Type A (power only)	"USB Power" on page 245

DSMC2 MONSTRO OPERATION GUIDE

DSMC2 JETPACK-SDI EXPANDER

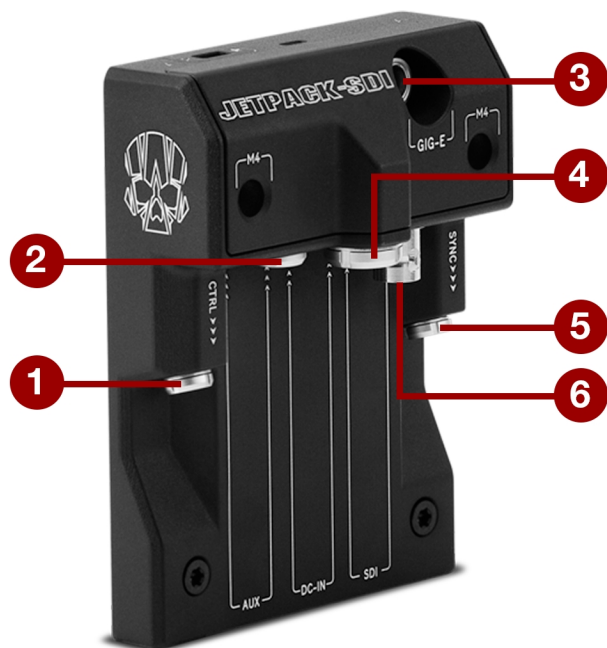

Figure: DSMC2 Jetpack-SDI Expander

#	CONNECTOR	CONNECTOR TYPE	DETAILS
1	CTRL	4-pin 00B	"CTRL (RS232 Control)" on page 233
2	AUX	2-Pin 0B	"AUX Power 2-Pin 0B, 1.5A" on page 244
3	GIG-E	9-pin 0B	"GIG-E (Ethernet)" on page 237
4	DC IN	6-pin 1B DC-IN	"DC IN (Power Input)" on page 242
5	SYNC	4-pin 00B	"SYNC (Video Sync In) with Contact Closure Style Trigger Input" on page 231
6	SDI	BNC	"3G-SDI (HD-SDI) Out" on page 226

DSMC2 MONSTRO OPERATION GUIDE

DSMC2 PRODUCTION MODULE

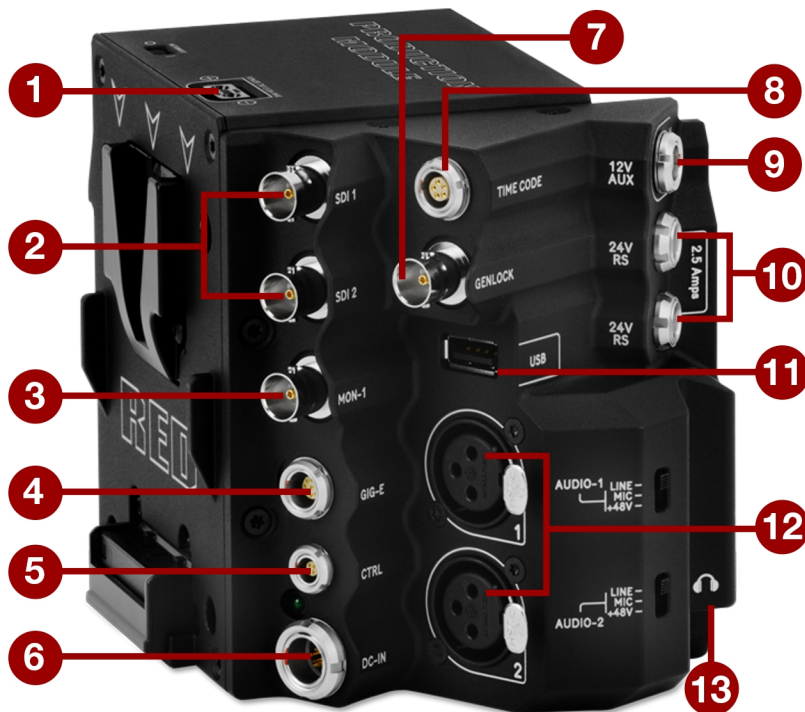

Figure: DSMC2 Production Module (V-Lock Pictured)

The DSMC2 Production Module (V-Lock) and DSMC2 Production Module (Gold Mount) feature the same input/output connectors. Aside from the battery plates, the two (2) versions of the DSMC2 Production Module are identical.

#	CONNECTOR	CONNECTOR TYPE	DETAILS
1	SDI 1 and 2	BNC	"3G-SDI (HD-SDI) Out" on page 226
2	MON-1	BNC	"MON-1" on page 227
3	GIG-E	9-pin 0B	"GIG-E (Ethernet)" on page 237
4	CTRL	4-pin 00B	"CTRL (RS232 Control)" on page 233
5	DC IN	6-pin 1B DC-IN	"DC IN (Power Input)" on page 242
6	POWER TAP	P-Tap 2-pin Female	"AUX Power (P-Tap)" on page 246
7	GENLOCK	BNC	"Genlock" on page 235
8	TIMECODE	5-Pin 0B	"Timecode" on page 236
9	12V AUX	2-Pin 0B	"AUX Power 2-Pin 0B, 3.0A" on page 243
10	24V RS 1 and 2	3-pin Fischer	"24V RS" on page 239
11	USB	USB 2.0 Type A (power only)	"USB Power" on page 245
12	AUDIO 1 and 2	3-pin full-size XLR	"Audio 1 and 2" on page 240
13	Headphone Jack	3.5mm stereo	"Headphone" on page 241

DSMC2 MONSTRO OPERATION GUIDE

DSMC2 TACTICAL TOP PLATE

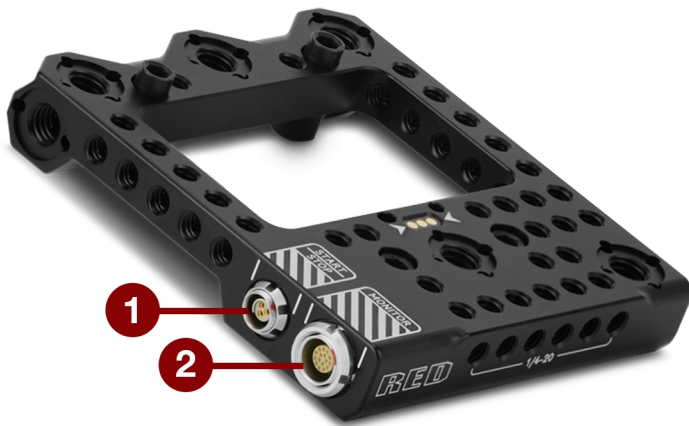

Figure: DSMC2 Tactical Top Plate

#	CONNECTOR	CONNECTOR TYPE	DETAILS
1	START/STOP	Fischer 3-pin 102	"START/STOP" on page 238
2	MONITOR	16-Pin 1B LCD/EVF connector	Custom digital video and power interconnection between the camera and RED LCD/EVF; Pinout not published

DSMC2 PRODUCTION TOP PLATE

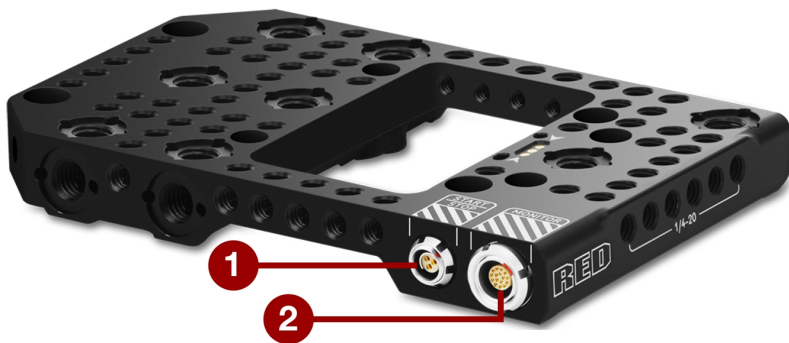

Figure: DSMC2 Production Top Plate

#	CONNECTOR	CONNECTOR TYPE	DETAILS
1	START/STOP	Fischer 3-pin 102	"START/STOP" on page 238
2	MONITOR	16-Pin 1B LCD/EVF connector	Custom digital video and power interconnection between the camera and RED LCD/EVF; Pinout not published

DSMC2 MONSTRO OPERATION GUIDE

RECORD/MONITOR OUT PORTS

3G-SDI (HD-SDI) OUT

The following devices feature an HD-SDI connector:

- ▶ DSMC2 Base Expander
- ▶ DSMC2 V-Lock I/O Expander
- ▶ DSMC2 REDVOLT Expander (labeled as “SDI-1” and “SDI-2”)
- ▶ DSMC2 Jetpack-SDI Expander (labeled as “SDI”)
- ▶ DSMC2 Production Module (labeled as “SDI-1” and “SDI-2”)

On the DSMC2 REDVOLT Expander and DSMC2 Production Module, SDI-1 and SDI-2 output a cloned 3G-SDI signal.

A standard 75 ohm BNC connector provides the following output:

- ▶ Legal range of HD-SDI signals
- ▶ Broadcast specification 3G-SDI (HD-SDI) video output (default mode is Clean)
- ▶ Two (2) channels of embedded audio
- ▶ Time of Day and Edge timecode
- ▶ Record Tally flag
- ▶ Clip name information (as SMPTE RP-188 VITC2 HANC metadata)

The 3G-SDI (HD-SDI) output provides the formats described in the table below:

3G-SDI (HD-SDI) OUTPUT FORMATS¹

VIDEO FEED ²	FREQUENCY (HZ) ³	SMPTE STANDARD
720p	23.98, 24.00, 25.00, 29.97, 30.00, 50.00, 59.94	SMPTE ST 292-1 (1.485 Gbps)
1080p 10-bit 4:2:2	23.98, 24.00, 25.00, 29.97, 30.00	SMPTE ST 292 (1.485 Gbps)
1080p 10-bit 4:2:2	50.00, 59.94, 60.00	3G-SDI SMPTE ST 424 (2.970 Gbps) SMPTE ST 425 (2.970 Gbps)

1. Ensure that you select a frequency supported by your monitor.
2. The output is progressive scan (p); it does not support progressive segmented frame (PsF) or interlaced (i) scan formats.
3. The frequency options depend on project time base. If you have a non-drop frame project time base (such as 24.00), you can select only non-drop frame frequencies. If you have a drop frame project time base (such as 23.98), you can select only drop frame frequencies.

75 OHM BNC CONNECTOR

PIN	SIGNAL	DESCRIPTION	DIRECTION
Center	3G-SDI	SMPTE ST 424	Out
Shield/Screen	GROUND	Camera ground	N/A

COMPATIBLE CABLE

- ▶ **790-0341:** RED® HD-SDI Cable (6')

DSMC2 MONSTRO OPERATION GUIDE

MON-1

The DSMC2 Production Module features a MON-1 out port. The DSMC2 Production Module converts an 8-bit RGB HDMI signal to a 10-bit 4:2:2 SDI feed, which is available via the MON-1 port. Due to this conversion, the color depth of the signal is limited to 8-bit.

The MON-1 port provides an additional monitor feed that is separate from the SDI-1 and SDI-2 cloned feeds.

The MON-1 output provides the formats described in the table below:

MON-1 OUTPUT FORMATS¹	
VIDEO FEED²	FREQUENCY (HZ)³
720p	50.00, 60.00
1080p	24.00, 25.00, 30.00, 50.00, 60.00

1. Ensure that you select a frequency supported by your monitor.
2. The output is progressive scan (p); it does not support progressive segmented frame (PsF) or interlaced (i) scan formats.
3. Supports only non-drop frame frequencies.

75 OHM BNC CONNECTOR			
PIN	SIGNAL	DESCRIPTION	DIRECTION
Center	SDI	SDI out	Out
Shield/Screen	GROUND	Camera ground	N/A

DSMC2 MONSTRO OPERATION GUIDE

HDMI OUT

The following expanders feature an HDMI 1.2 (Type A) connector:

- ▶ DSMC2 Base Expander
- ▶ DSMC2 V-Lock I/O Expander
- ▶ DSMC2 Jetpack Expander
- ▶ DSMC2 REDVOLT Expander

NOTE: For more information about HDMI wireless transmitter support, go to "[HDMI Wireless Transmitters](#)" below.

A standard HDMI connector provides the following output:

- ▶ High-definition video output (default mode is Overlay)
- ▶ Two (2) channels of embedded audio

The HDMI output provides the formats described in the table below:

HDMI OUTPUT FORMATS ¹	
VIDEO FEED ²	FREQUENCY (HZ)
480p	50.00, 60.00
720p	24.00, 25.00, 30.00, 50.00, 60.00
1080p	24.00, 25.00, 30.00, 50.00, 60.00

1. Ensure that you select a frequency supported by your monitor.
2. The HDMI output is progressive scan (p); it does not support progressive segmented frame (PsF) or interlaced (i) scan formats.

COMPATIBLE CABLE

- ▶ **790-0331:** RED HDMI Cable (5')

HDMI WIRELESS TRANSMITTERS

The HDMI connector supports HDMI wireless transmitters, so that you can transmit the HDMI signal to a remote HDMI monitor. The HDMI connector supports industry-standard HDMI wireless transmitters.

NOTE: The DSMC2 Jetpack Expander features a spring-loaded retainer that keeps a mounted HDMI wireless transmitter firmly in place. A wireless transmitter that is longer than 9.8 cm (including the HDMI connector) might not fit in the retainer.

NOTE: The DSMC2 V-Lock I/O Expander, DSMC2 Jetpack Expander, and DSMC2 REDVOLT Expander have a USB power out connector that provides 5 V at 1.5A, which powers most industry-standard HDMI wireless transmitters. For more information, go to "[USB Power](#)" on page 245.

DSMC2 MONSTRO OPERATION GUIDE

COMMUNICATION PORTS

SYNC (VIDEO SYNC IN) WITH SYNC TRIGGER BUTTON CIRCUIT

The DSMC2 Base Expander features a SYNC connector with a SYNC Trigger Button Circuit.

The 4-Pin 00B Sync Connector accepts timecode, genlock, and General Purpose Input (GPI) signals.

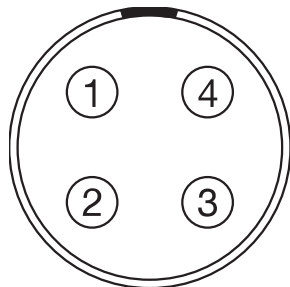

Figure: Front Face of the SYNC (Video Sync) Connector (Looking at the Camera)

4-PIN 00B SYNC CONNECTOR

PIN	SIGNAL	DESCRIPTION	DIRECTION
1	GROUND	Common ground	N/A
2	SS/GPI	Shutter sync/general purpose input trigger	In
3	TIMECODE	SMPTE unbalanced timecode input	In
4	GENLOCK	Tri-level sync input	In

NOTE: Mating connector is FGG.00.304.CLAD.

DSMC2 MONSTRO OPERATION GUIDE

SYNC TRIGGER BUTTON CIRCUIT

The SYNC connector has a 3.3 V Schmitt trigger (5 V tolerant). The trigger is not a switch closure circuit, so it requires that the trigger source supplies current. Both edges of the input signal may be used as a trigger.

NOTE: The SYNC trigger button circuit only applies to the DSMC2 Base Expander.

For example, this is the behavior of the circuit when the GPI trigger is used for record start/stop:

- ▶ **Start Record:** On ground to 3.3 V transition
- ▶ **During Record:** Hold at 3.3 V
- ▶ **Stop Record:** On 3.3 V to ground transition
- ▶ **During Stop:** Hold at ground

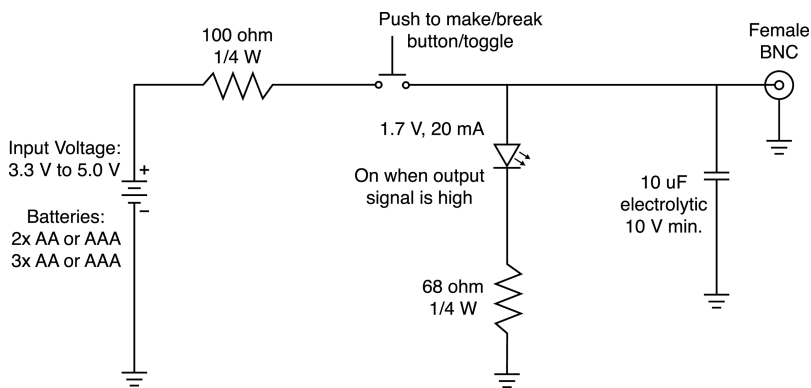

Figure: Trigger Button Circuit Diagram

NOTE: In the diagram above, values are approximate. Use standard values.

COMPATIBLE CABLES

- ▶ **790-0154, 790-0643:** 3BNC-to-00 Sync Cable
- ▶ **790-0187, 790-0648:** 4-Pin 00B-to-Flying Lead
 - ▶ **White:** Ground
 - ▶ **Yellow:** RS232 RX
 - ▶ **Blue:** Shutter/sync, general purpose output
 - ▶ **Red:** RS232 TX
 - ▶ **Black:** Shield
- ▶ **790-0415:** RED Start/Stop Cable (14-Pin 1B to SYNC, CTRL, BNC)
- ▶ **790-0428:** RED Start/Stop Cable (14-Pin to 00B SYNC)

DSMC2 MONSTRO OPERATION GUIDE

SYNC (VIDEO SYNC IN) WITH CONTACT CLOSURE STYLE TRIGGER INPUT

The following devices feature a SYNC connector with contact closure style trigger input:

- ▶ DSMC2 Jetpack Expander
- ▶ DSMC2 Jetpack-SDI Expander
- ▶ DSMC2 V-Lock I/O Expander

The 4-Pin 00B Sync Connector accepts timecode, genlock, and General Purpose Input (GPI) signals. To operate the GPI contact closure style trigger, short Pin 2 (GPI) to Pin 1 (ground).

WARNING: DO NOT apply voltage to Pin 2 (GPI).

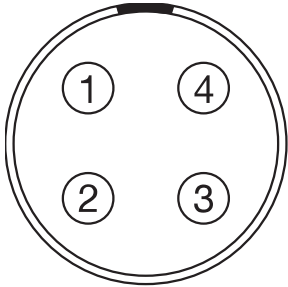

Figure: Front Face of the SYNC (Video Sync) Connector (Looking at the Camera)

4-PIN 00B SYNC CONNECTOR

PIN	SIGNAL	DESCRIPTION	DIRECTION
1	GROUND	Common ground	N/A
2	GPI	General purpose input trigger; contact closure to Pin 1	In
3	TIMECODE	SMPTE unbalanced timecode input	In
4	GENLOCK	Tri-level sync input	In

NOTE: Mating connector is FGG.00.304.CLAD.

DSMC2 MONSTRO OPERATION GUIDE

CONTACT CLOSURE STYLE TRIGGER BUTTON CIRCUIT (SYNC)

The diagram below shows the contact closure style trigger button circuit on the SYNC connector.

Momentary Action

Push Button

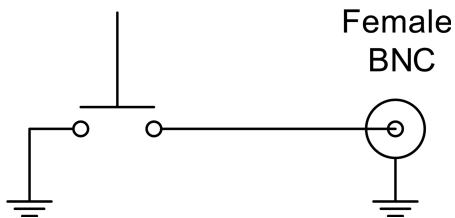

Figure: Contact Closure Style Trigger Button Circuit Diagram (SYNC)

COMPATIBLE CABLES

- ▶ **790-0154, 790-0643:** 3BNC-to-00 Sync Cable
- ▶ **790-0187, 790-0648:** 4-Pin 00B-to-Flying Lead
 - ▶ **White:** Ground
 - ▶ **Yellow:** RS232 RX
 - ▶ **Blue:** Shutter/sync, general purpose output
 - ▶ **Red:** RS232 TX
 - ▶ **Black:** Shield
- ▶ **790-0415:** RED Start/Stop Cable (14-Pin 1B to SYNC, CTRL, BNC)
- ▶ **790-0428:** RED Start/Stop Cable (14-Pin to 00B SYNC)

DSMC2 MONSTRO OPERATION GUIDE

CTRL (RS232 CONTROL)

The following devices feature a CTRL connector:

- ▶ DSMC2 Base Expander
- ▶ DSMC2 V-Lock I/O Expander
- ▶ DSMC2 Jetpack Expander
- ▶ DSMC2 Jetpack-SDI Expander
- ▶ DSMC2 REDVOLT Expander
- ▶ DSMC2 Production Module

The 4-Pin 00B CTRL Connector supports RS232 remote control for 3D camera communication and third-party metadata ingest applications. For more information, go to "[BRAIN GPIO](#)" on page 149.

The General Purpose Out (GPO) tally presents 3.3 V at a maximum of 0.04 A between pins 1 and 3. When used as a record tally, the rising edge of the pulse indicates start of record, falling edge represents end of record.

For more information about controlling the camera via RS232, download the [R.C.P.™ SDK](#), available at www.red.com/developers.

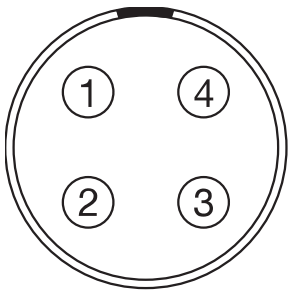

Figure: Front Face of the CTRL (RS232) Connector (Looking at the Camera)

4-PIN 00B CTRL CONNECTOR

PIN	SIGNAL	DESCRIPTION	DIRECTION
1	GROUND	Common ground	N/A
2	232 RX	RS232 RX	In
3	SS/GPO	Shutter sync/general purpose output	Out
4	232 TX	RS232 TX	Out

NOTE: Mating connector is FGG.00.304.CLAD.

DSMC2 MONSTRO OPERATION GUIDE

COMPATIBLE CABLES

- ▶ **790-0154, 790-0643:** 3BNC-to-00 Sync Cable
- ▶ **790-0187, 790-0648:** 4-Pin 00B-to-Flying Lead
 - ▶ **White:** Ground
 - ▶ **Yellow:** RS232 RX
 - ▶ **Blue:** Shutter/sync, general purpose output
 - ▶ **Red:** RS232 TX
 - ▶ **Black:** Shield
- ▶ **790-0415:** RED Start/Stop Cable (14-Pin 1B to SYNC, CTRL, BNC)

SERIAL (RS232 CONTROL)

The DSMC2 REDVOLT Expander features a SERIAL connector. The 7-Pin 0B SERIAL port connector supports RS232 RX, RS232 TX, and a General Purpose Input (GPI) trigger (active-low switch closure). The connector also offers auxiliary power out, with a maximum sustained current draw of 1.5A.

To operate the GPI contact closure style trigger, short Pin 7 (GPI) to Pin 6 (ground).

The SERIAL connector was designed to support 6-pin 0B cables used with the RED Tactical Hand Controller (T.H.C.). Although the connectors on those cables do not have pin 7 (GPI), the other 6 pins do match pins 1 to 6 on the SERIAL connector.

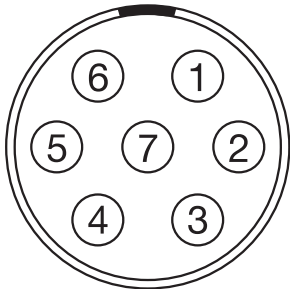

Figure: Front Face of the SERIAL (RS232) Connector (Looking at the Camera)

SERIAL CONNECTOR

PIN	SIGNAL	DESCRIPTION	DIRECTION
1	GND	Camera ground	N/A
2	RS232 RX	RS232 RX	In
3	RS232 TX	RS232 TX	Out
4	AUX OUT	+11.5 to +17 VDC unregulated battery pass-through power	Out
5	N/A	No connection (NC)	N/A
6	GND	Camera ground	N/A
7	GPI	General Purpose In (GPI) trigger (active-low switch closure)	In

NOTE: Mating connectors are FHG.0B.307.CLAD (right-angle) or FGG.0B.307.CLAD (straight).

DSMC2 MONSTRO OPERATION GUIDE

CONTACT CLOSURE STYLE TRIGGER BUTTON CIRCUIT

The diagram below shows the contact closure style trigger button circuit on the connector.

Momentary Action

Push Button

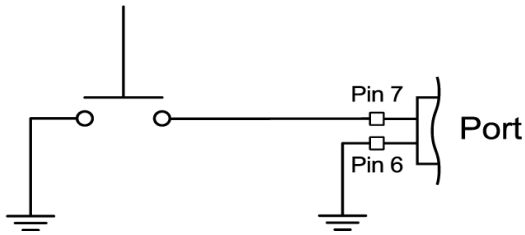

Figure: Contact Closure Style Trigger Button Circuit Diagram

COMPATIBLE CABLES

For GPI applications, you can use this cable:

- ▶ **790-0553, 790-0653:** RED 7-Pin 0B-to-Flying Lead Serial Port Cable (6')

For non-GPI applications, you can use this 6-pin cable:

- ▶ **790-0444:** R.C.P.[®]-to-T.H.C. Connector Cable 3'

GENLOCK

The DSMC2 REDVOLT Expander features a Genlock (GEN) connector.

The 75 ohm BNC connector accepts incoming sync and genlock signals.

75 OHM BNC CONNECTOR

PIN	SIGNAL	DESCRIPTION	DIRECTION
Center	SYNC	SMPTE ST 274 RS 170A Tri-Level Sync	In
Shield/Screen	GROUND	Camera ground	N/A

COMPATIBLE CABLE

- ▶ **790-0341:** RED HD-SDI Cable (6')

DSMC2 MONSTRO OPERATION GUIDE

TIMECODE

The following devices feature a TIMECODE connector:

- ▶ DSMC2 REDVOLT Expander
- ▶ DSMC2 Production Module

The LEMO EAG.0B.305.CLN connector supports SMPTE timecode input and output. Pins 2 and 3 can be used together to receive a balance SMPTE 12M serial timecode input. Pin 2 can be used by itself (leave pin 3 open) to receive a single-ended SMPTE 12M serial timecode input. Pin 5 is a timecode output.

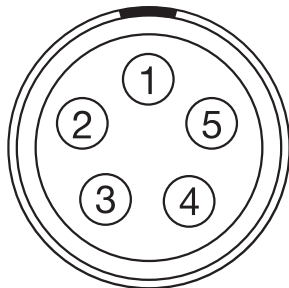

Figure: Front Face of Timecode (LEMO EAG.0B.305.CLN) Connector (Looking at the Camera)

LEMO EAG.0B.305.CLN CONNECTOR

PIN	SIGNAL	DESCRIPTION	DIRECTION
1	GROUND	Camera Ground	N/A
2	TIMECODE IN(S)	Timecode input - SMPTE single ended	In
3	N/A	No connection (NC)	N/A
4	+5 V OUT	+5 V out, 200 mA max	Out
5	TIMECODE OUT	SMPTE 12 M Timecode output	Out

NOTE: Mating connector is FHG.0B.305.CLAD.

COMPATIBLE CABLE

- ▶ **790-0212:** Pro I/O Time Code Cable 3'

DSMC2 MONSTRO OPERATION GUIDE

GIG-E (ETHERNET)

The following devices feature a GIG-E connector.

- ▶ DSMC2 Jetpack-SDI Expander
- ▶ DSMC2 REDVOLT Expander
- ▶ DSMC2 Production Module

The GIG-E 9-pin 0B connector provides a 1000BASE-T (IEEE 802.3ab) gigabit Ethernet connection for remote camera setup, master/slave camera communication, and external metadata ingest. Since the GIG-E connector does not support slower speeds (10BASE-T and 100BASE-T), ensure that any device you connect to supports 1000BASE-T.

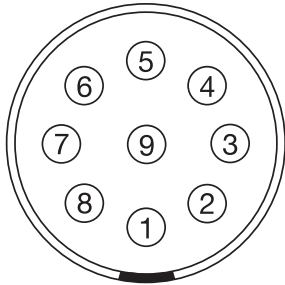

Figure: Front Face of the GIG-E Connector (Looking at the Camera)

9-PIN 0B GIG-E CONNECTOR

PIN	SIGNAL	DESCRIPTION	DIRECTION
1	BI_DC+	Data pair C+	N/A
2	BI_DC-	Data pair C-	N/A
3	BI_DD+	Data pair D+	N/A
4	BI_DD-	Data pair D-	N/A
5	BI_DA-	Data pair A-	N/A
6	BI_DA+	Data pair A+	N/A
7	BI_DB+	Data pair B+	N/A
8	BI_DB-	Data pair B-	N/A
9	N/A	Do not connect	N/A

NOTE: Mating connector is FGG.0B.309.CLAD.

COMPATIBLE CABLES

- ▶ **790-0159:** RED GIG-E Straight-to-CAT5E Ethernet Cable (9')
- ▶ **790-0557, 790-0655:** RED GIG-E Right-to-CAT5E Ethernet Cable (9')
- ▶ **790-0163:** Master/Slave Gig-E Cable (4')

DSMC2 MONSTRO OPERATION GUIDE

START/STOP

The following devices feature a START/STOP connector:

- ▶ DSMC2 Tactical Top Plate
- ▶ DSMC2 Production Top Plate

The Fischer 3-pin 102 supports record start/stop via compatible third-party triggers.

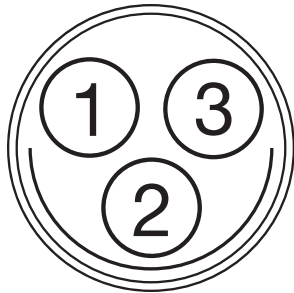

Figure: START/STOP Connector (Looking at the Connector)

FISCHER 3-PIN CONNECTOR

PIN	SIGNAL	DESCRIPTION	DIRECTION
1	GROUND	Common ground	N/A
2	N/A	No connection (NC)	N/A
3	R/S	Active Low to start/stop record	In

DSMC2 MONSTRO OPERATION GUIDE

24V RS

The DSMC2 Production Module features two (2) 24V RS (run/stop) connectors.

The two (2) Fischer 3-pin 102 connectors supply a combined 24V power out at a maximum sustained current draw of 2.5A. Each connector also includes a run/stop (R/S) trigger input. To operate the contact closure style trigger, short Pin 3 (R/S) to Pin 1 (ground).

WARNING: DO NOT apply voltage to Pin 3 (R/S).

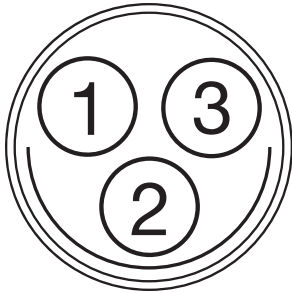

Figure: 24V RS (Looking at the Connector)

FISCHER 3-PIN CONNECTOR

PIN	SIGNAL	DESCRIPTION	DIRECTION
1	GROUND	Common ground	N/A
2	+24 V OUT	+24 V out, 2.5A max (shared between the connectors)	Out
3	R/S	Active Low to start/stop record (3.3V pull up)	In

CONTACT CLOSURE STYLE TRIGGER BUTTON CIRCUIT (24V RS)

The diagram below shows the contact closure style trigger button circuit on the 24V RS connector.

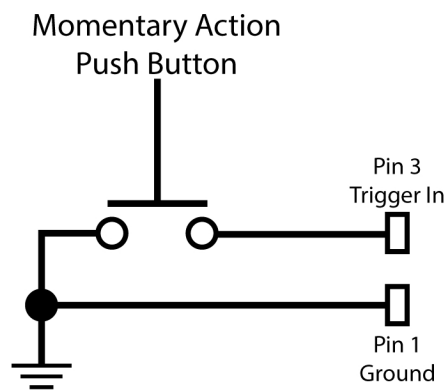

Figure: Contact Closure Style Trigger Button Circuit Diagram (24V RS)

DSMC2 MONSTRO OPERATION GUIDE

AUDIO PORTS

STEREO MICROPHONE

The following expanders feature a stereo microphone jack:

- ▶ DSMC2 Base Expander
- ▶ DSMC2 V-Lock I/O Expander

The 3.5mm stereo microphone provides two (2) channels of audio for recording.

HEADPHONE JACK

PIN	SIGNAL	DESCRIPTION	DIRECTION
TIP	LEFT	Left channel audio	In
RING	RIGHT	Right channel audio	In
SLEEVE	GND	Camera ground	N/A

AUDIO 1 AND 2

The following devices feature two (2) full-size XLR audio in connectors:

- ▶ DSMC2 REDVOLT Expander
- ▶ DSMC2 Production Module

The two (2) 3-pin XLR connectors provide input for two (2) audio channels. Each port supports 48 V 10mA phantom power. Each input may be independently set to either line or microphone level. If a channel is set to microphone, you can independently enable its 48 V phantom power output.

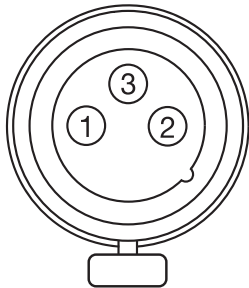

Figure: Front Face of Audio Input (3-PIN XLR) Connector (Looking at the Camera)

3-PIN XLR CONNECTOR

PIN	SIGNAL	DESCRIPTION	DIRECTION
1	GROUND	Camera ground	N/A
2	MIC/LIN IN +	Mic/Line input (+) 48 V phantom power	In
3	MIC/LIN IN -	Mic/Line input (-) 48 V phantom power	In

DSMC2 MONSTRO OPERATION GUIDE

HEADPHONE

The following devices feature a headphone jack:

- ▶ DSMC2 Base Expander
- ▶ DSMC2 V-Lock I/O Expander
- ▶ DSMC2 REDVOLT Expander
- ▶ DSMC2 Production Module

The 3.5mm stereo jack provides two (2) channels of audio for monitoring. For maximum quality, use high impedance headphones.

HEADPHONE JACK

PIN	SIGNAL	DESCRIPTION	DIRECTION
TIP	LEFT	Left channel audio	Out
RING	RIGHT	Right channel audio	Out
SLEEVE	GND	Camera ground	N/A

DSMC2 MONSTRO OPERATION GUIDE

POWER PORTS

DC IN (POWER INPUT)

The following devices feature a DC IN connector:

- ▶ DSMC2 Base Expander
- ▶ DSMC2 V-Lock I/O Expander
- ▶ DSMC2 Jetpack Expander
- ▶ DSMC2 Jetpack-SDI Expander
- ▶ DSMC2 REDVOLT Expander
- ▶ DSMC2 Production Module

The 6-Pin 1B DC-IN connector accepts DC input power from 11.5 V DC to 17 V DC. A built-in power conditioner protects against reverse-polarity connections, electrostatic discharge (ESD), undervoltage, overvoltage, and overcurrent.

WARNING: Both pairs of +VBATT and GROUND pins must be wired. Using a third-party power cable that wires only one (1) pair of +VBATT and GROUND pins may damage the power supply or the camera. Damage to the power supply or other components of the camera system caused by using an inappropriate power cable is not covered under warranty.

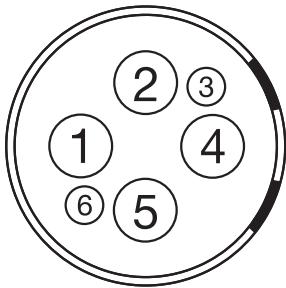

Figure: Front Face of the DC In Power Input Connector (Looking at the Camera)

6-PIN 1B DC INPUT CONNECTOR

PIN	SIGNAL	DESCRIPTION
1	+VBATT	Power input, +11.5 to +17 V DC
2	+VBATT	Power input, +11.5 to +17 V DC
3	SCL-BATT	Serial battery bus clock
4	GROUND	Power return (camera ground)
5	GROUND	Power return (camera ground)
6	SDA-BATT	Serial battery bus data

NOTE: Mating connector is FGJ.1B.306.CWLD72Z.

DSMC2 MONSTRO OPERATION GUIDE

COMPATIBLE CABLES

- ▶ **790-0138:** RED 2B-to-1B Power Adaptor Cable
- ▶ **790-0164, 790-0646:** XLR Power Cable (10')
- ▶ **790-0165, 790-0647:** XLR Power Cable (30')

AUX POWER 2-PIN 0B, 3.0A

The following devices feature an auxiliary power out connector (3.0A):

- ▶ DSMC2 REDVOLT Expander
- ▶ DSMC2 Production Module

The 2-Pin 0B connector (LEMO EEG.0B.302.CLL) supplies unregulated (+) 11.5 to 17 VDC battery pass-through power. The maximum sustained current draw is 3.0A.

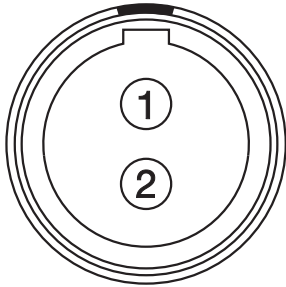

Figure: Front Face of Connector (Looking at the Camera)

LEMO EEG.0B.302.CLL CONNECTOR

PIN	SIGNAL	DESCRIPTION	DIRECTION
1	GROUND	Common ground	N/A
2	+11.5 to +17 VDC	+11.5 to 17 VDC unregulated battery pass-through power	Out

NOTE: Mating connector is FGG.00.302.CLAD35Z.

COMPATIBLE CABLE

- ▶ **790-0410:** RED W.M.D. Power Cable 2-Pin 1B to 2-Pin 0B (18')

DSMC2 MONSTRO OPERATION GUIDE

AUX POWER 2-PIN 0B, 1.5A

The DSMC2 Jetpack-SDI Expander features an auxiliary power out connector (1.5A):

The 2-Pin 0B connector (LEMO EEG.0B.302.CLL) supplies unregulated (+) 11.5 to 17 VDC battery pass-through power. The maximum sustained current draw is 1.5A.

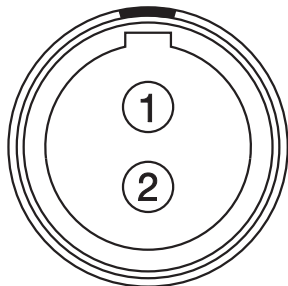

Figure: Front Face of AUX PWR Connector (Looking at the Camera)

LEMO EEG.0B.302.CLL CONNECTOR

PIN	SIGNAL	DESCRIPTION	DIRECTION
1	GROUND	Common ground	N/A
2	+11.5 to +17 VDC	+11.5 to 17 VDC unregulated battery pass-through power	Out

NOTE: Mating connector is FGG.00.302.CLAD35Z.

COMPATIBLE CABLE

- ▶ **790-0410:** RED W.M.D. Power Cable 2-Pin 1B to 2-Pin 0B (18")

DSMC2 MONSTRO OPERATION GUIDE

AUX POWER (4-PIN 0B)

The DSMC2 REDVOLT Expander features an auxiliary power out connector.

The LEMO EAG.0B.304.CLN connector supplies unregulated (+) 11.5 to 17 VDC battery pass-through power. The maximum sustained current draw is 1.5A.

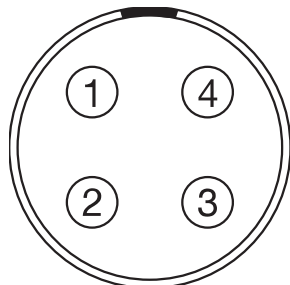

Figure: Front Face of AUX PWR Connector (Looking at the Camera)

LEMO EAG.0B.304.CLN CONNECTOR

PIN	SIGNAL	DESCRIPTION	DIRECTION
1	GROUND	Camera Ground	N/A
2	GPI	General purpose input trigger (GPI), use for trigger in	In
3	GPO	General purpose output trigger (GPO), use for tally out	Out
4	+11.5 to +17 VDC	+11.5 to 17 VDC unregulated battery pass-through power	Out

NOTE: Mating connector is FGG.0B.304.CLAD.

COMPATIBLE CABLE

- ▶ **790-0552, 790-0652:** RED 4-Pin 0B-to-Flying Lead AUX Power Cable (6')

USB POWER

The following devices feature a USB 2.0 (Type A) power out connector:

- ▶ DSMC2 Jetpack Expander
- ▶ DSMC2 V-Lock I/O Expander
- ▶ DSMC2 REDVOLT Expander
- ▶ DSMC2 Production Module

The USB power out connector supplies 5 V of power. The maximum sustained current draw is 1.5A.

You can use the USB power out connector to provide power to an attached HDMI wireless transmitter.

NOTE: The USB connector only offers power out, and does NOT support USB communication.

DSMC2 MONSTRO OPERATION GUIDE

AUX POWER (P-TAP)

The following devices feature an AUX power out connector:

- ▶ DSMC2 V-Lock I/O Expander
- ▶ DSMC2 Production Module

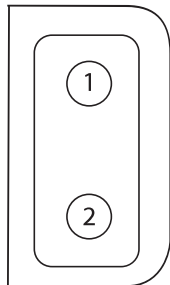

Figure: P-Tap Connector (Looking at Camera)

The AUX power out connector features an industry-standard P-Tap connector and supplies conditioned VBATT at a maximum of 3.0A of power.

2-PIN P-TAP CONNECTOR

PIN	SIGNAL	DESCRIPTION	DIRECTION
1	GROUND	Common ground	N/A
2	+11.5 to +17 VDC	+11.5 to 17 VDC unregulated battery pass-through power	Out

APPENDIX D:

LENS MOUNTS AND LENSES

LENS MOUNTS

This section describes camera lens mounts. Camera mounts may be configured with 19mm rods to accommodate most cinematography lenses, matte boxes, and follow focus systems.

WARNING: All lenses are hot swappable. However, lens mounts are NOT HOT SWAPPABLE, meaning you cannot remove or install lens mounts while the camera is turned on. Before installing or removing lens mounts, you MUST turn off the camera. Failure to do so may result in damage to the lens mounts or camera that is not covered under warranty.

DSMC RED MOTION MOUNT

The DSMC RED[®] MOTION MOUNT[®] S35 lens mount is a revolutionary and adjustable lens mount system for your camera. By integrating a global shutter, temporal anti-aliasing soft shutter, and variable neutral density (ND) system into a single lens mount, the DSMC RED MOTION MOUNT S35 lens mount delivers on-the-fly shutter adjustments to reduce motion blur and temporal aliasing. The ND filter also includes a linear polarizer and IR filter for improved image color and contrast.

For more information, see the [MOTION MOUNT Operation Guide](http://www.red.com/downloads), available at www.red.com/downloads.

NOTE: HDRX is not available when the MOTION MOUNT Shutter Type is set to Soft or Square.

REMOVE A LENS MOUNT

NOTE: You can change lens mounts in the field. However, RED[®] recommends that you change lens mounts only in a dust-free environment.

REQUIRED TOOL(S): T20 TORX[®] driver

1. Turn off the camera.
2. Attach the camera to a stable platform or position the camera on a clean and level work surface so that the lens mount screws are accessible.
3. Remove the lens and any devices, cables, or other accessories that might interfere with removing the lens mount.

DSMC2 MONSTRO OPERATION GUIDE

4. Depending on the lens mount, you may need to turn the locking ring slightly counter-clockwise so that you can access the lens mount screws.



Figure: Turn Locking Ring Counter-Clockwise

5. Loosen and remove the four (4) M4x0.7 x 8 mm lens mount screws in a cross pattern ("X" pattern) using a T20 TORX driver.

NOTE: Some lens mounts have captive screws that are not removable.

NOTE: Screw removal may require a large handle T20 TORX driver and additional leverage.



Figure: Remove the Lens Mount Screws

DSMC2 MONSTRO OPERATION GUIDE

6. Remove the lens mount from the camera.



Figure: Remove the Lens Mount

DSMC2 MONSTRO OPERATION GUIDE

INSTALL A LENS MOUNT

NOTE: You can change lens mounts in the field. However, RED recommends that you change lens mounts only in a dust-free environment.

REQUIRED TOOL(S): T20 TORX driver

1. Ensure that the camera is turned off and remove any accessories or cables that may interfere with installation.
2. Inspect the gold electrical contact pins on the front of the camera and the gold contact pads on the rear of the lens mount to ensure that they are free of any contamination.
3. Align the lens mount on the front of the camera. The camera connection pins must align with the lens mount pins.



Figure: Align Lens Mount Pins

4. Depending on the lens, you may need to turn the locking ring slightly counter-clockwise so that you can access the lens mount screws.
5. Replace and loosely tighten the four (4) M4x0.7 x 8 mm lens mount screws in a cross pattern ("X" pattern) using a T20 TORX driver.

WARNING: DO NOT FULLY TIGHTEN.

NOTE: Some lens mounts have captive screws that are not removable.



Figure: Tighten Screws

DSMC2 MONSTRO OPERATION GUIDE

6. Tighten the four (4) lens mount screws evenly in a cross pattern (“X” pattern) using a T20 TORX driver. DO NOT exceed 350 in-oz, or damage may occur.

WARNING: DO NOT OVERTIGHTEN.

7. After installation, a hardware rediscover or firmware upgrade may be required, particularly if you are installing a MOTION MOUNT. To perform a hardware rediscover, go to **Menu > Settings > Maintenance > Rediscover**. A system reboot is required after a hardware rediscover.

NOTE: If you need to replace any screws, submit a Support ticket at <https://support.red.com>.

LENSES

To avoid vignetting, use standard full frame PL mount lenses.

NOTE: Lenses are hot swappable.

LENS WEIGHT AND LENS SUPPORT

Use a lens support system when mounting heavy or long lenses to your camera.

When mounting a heavy or long lens, ensure that the full weight of the lens is never directly on the camera or lens mount. Mount the lens to the support system first, and then carefully mount the lens to the camera.

Due to the lightweight construction of the carbon fiber BRAIN and magnesium mounts, most setups with the carbon fiber BRAIN require a lens support system for all but the lightest lenses.

WARNING: Failure to use lens supports appropriate for the lens and camera setup may lead to damage of the camera and lens mount. Any damage caused by not using a lens support system is not covered under warranty.

POSITIVE LOCK (PL) LENSES

This section describes the appropriate method for attaching and detaching PL lenses. For more information, refer to the original manufacturer’s instructions. This section also lists lenses supported by the camera PL mounts.

WARNING: ALWAYS protect your equipment, when it is not in use, by replacing lens caps and mount caps.

ATTACH PL LENSES

1. Rotate the locking ring counter-clockwise to release the camera mount cap.
2. Remove the rear lens cap and the camera mount cap.
3. Align the key and contact pads (if present) on the PL lens with the key and connector pins on the camera PL mount.
4. Insert the lens into the camera PL mount.
5. Rotate the locking ring clockwise to secure the lens in place.

DETACH PL LENSES

1. Rotate the locking ring counter-clockwise to release the PL lens.
2. Remove the PL lens from the camera PL mount.
3. Replace the rear lens cap and camera mount cap when the lens is not in use.

DSMC2 MONSTRO OPERATION GUIDE

CAMERA PL MOUNT SUPPORTED LENSES

The RED DSMC PL lens mounts and the DSMC RED MOTION MOUNT S35 Ti PL lens mount are compatible with most standard PL mount cinema lenses and devices. For information about the compatibility of the DSMC RED MOTION MOUNT S35 Ti PL lens mount, see the [MOTION MOUNT Operation Guide](http://www.red.com/downloads) at www.red.com/downloads.

WARNING: Using a non-standard PL mount lens or device with a camera PL mount may damage the camera and lens mount. Any damage caused by not using a standard PL mount lens or device is not covered under warranty.

FUJINON T2.9 CABRIO PREMIER PL LENSES

NOTE: The VTR switch on the lens is mapped to Record: Toggle by default. The VTR switch can be mapped to another key.

NOTE: Fujinon lenses running older versions of lens firmware might not send correct data to the camera.

The following Fujinon® T2.9 Cabrio Premier PL lenses are compatible with all camera PL mounts, but must be powered externally and configured a specific way:

- ▶ Fujinon 14-35mm T2.9 Cabrio Premier PL
- ▶ Fujinon 19-90mm T2.9 Cabrio Premier PL

To set up the Fujinon T2.9 Cabrio Premier PL lenses, follow the instructions below. Refer to the manufacturer's operation manual for detailed information about setting up and using the lens.

1. Attach the lens to the camera PL mount.
2. Ensure that the lens has lens firmware v6.4 or later (to check version in the camera, go to **Menu > Settings > Setup > Lens > Lens Info**). Contact the manufacturer for lens firmware.
3. On the lens, set the **Camera Communication** switch to **On**.
4. On the lens, set the **LDS, /i Select** switch to **Off**.
5. Connect an external power source to the lens.
6. In the camera, to **Menu > Settings > Setup > Lens**.
7. Deselect the **Enable Power to Lens** check box.
NOTE: This option is only available when a camera PL mount is attached to the camera.
8. The lens should be successfully connected. However, if lens data does not display within 10 seconds, go to **Menu > Settings > Setup > Lens** and select **Detect Lens**.

CANON PL MOUNT LENSES

The following Canon PL mount lenses are compatible with all camera PL mounts, but must be configured a specific way:

- ▶ Canon CN7x17 KAS S Cine-Servo 17-120mm T2.95
- ▶ Canon CN20x50 IAS H Cine-Servo 50-1000mm

Requirements for using these Canon PL mount lenses:

- ▶ The lens requires lens firmware v6.4 or later; contact the manufacturer for lens firmware.
- ▶ In the camera, go to **Menu > Settings > Setup > Lens**, and select the **Enable Power to Lens** check box.
- ▶ RED recommends using an external battery for the lens, since the lens mount provides a limited supply of power to the lens.

DSMC2 MONSTRO OPERATION GUIDE

CANON EF LENSES

This section describes the appropriate method for attaching and detaching Canon® EF lenses. For more information, refer to the original manufacturer's instructions.

This section also lists lenses supported by the DSMC® Canon EF Mount.

WARNING: ALWAYS protect your equipment, when it is not in use, by replacing lens caps and mount caps.

ATTACH CANON EF LENSES

1. Rotate the secondary locking ring counter-clockwise to disengage.
2. Press the lens release button and rotate the lens cap counter-clockwise to remove the camera mount cap.
3. Remove the rear lens cap.
4. Align the red dot on the lens with the red dot on the DSMC Canon Mount and position the lens in the mount.
5. Turn the lens clockwise until it clicks into place.
6. Rotate the secondary locking ring clockwise to engage.

DETACH CANON EF LENSES

1. Rotate the secondary locking ring counter-clockwise to disengage.
2. Press and hold the lens release button. While holding the lens release button, turn the lens counterclockwise until it stops and remove it from the camera mount.
3. Replace the rear lens cap and camera mount cap when the lens is not in use.

DSMC2 MONSTRO OPERATION GUIDE

DSMC CANON MOUNT SUPPORTED LENSES

The DSMC Canon Mount and DSMC RED MOTION MOUNT S35 Ti Canon (Captive) lens mount electronically support the following lenses:

COMPATIBLE LENS TYPE	FOCAL LENGTH
Canon CN-E	Canon CN-E 18-80mm T4.4 COMPACT-SERVO ¹
Canon EF	Canon EF 8-15mm f/4L Fisheye USM
	Canon EF 11-24mm f/4L USM
	Canon EF 14mm f/2.8L II USM
	Canon EF 15mm f/2.8 Fisheye
	Canon EF 15-85mm f/3.5 IS USM
	Canon EF 16-35mm f/2.8L II
	Canon EF 17-40mm f/4L
	Canon EF 20mm f/2.8 USM
	Canon EF 24mm f/1.4L II
	Canon EF 24mm f/2.8
	Canon EF 24mm f/2.8 IS USM
	Canon EF 24-70mm f/2.8L
	Canon EF 24-70mm f/2.8L II USM
	Canon EF 24-70mm f/4L IS USM
	Canon EF 24-105mm f/4L IS
	Canon EF 28mm f/1.8 USM
	Canon EF 28mm f/2.8
	Canon EF 28mm f/2.8 IS USM
	Canon EF 28-105mm f3.5 II USM
	Canon EF 28-300mm f/3.5-5.6L IS
	Canon EF 35mm f/1.4L
	Canon EF 35mm f/2
	Canon EF 35mm f/2 IS USM
	Canon EF 40mm f/2.8 STM
	Canon EF 50mm f/1.2L
	Canon EF 50mm f/1.4 USM
	Canon EF 50mm f/1.8 II
	Canon EF 50mm f/1.8 STM
	Canon EF 50mm f/2.5 Compact Macro
	Canon EF 70-200mm f/2.8L IS
	Canon EF 70-200mm f/2.8L IS with 1.4x Extender
	Canon EF 70-200mm f/2.8L IS with 2x Extender
	Canon EF 70-200mm f/2.8L IS II USM

DSMC2 MONSTRO OPERATION GUIDE

COMPATIBLE LENS TYPE	FOCAL LENGTH
Canon EF	Canon EF 70-200mm f/2.8 L IS II with 1.4x Extender
	Canon EF 70-200mm f/2.8 L IS II with 2x Extender
	Canon EF 70-200mm f/2.8L USM
	Canon EF 70-200mm f/4L
	Canon EF 70-200mm f/4L with 1.4x Extender
	Canon EF 70-200mm f/4L with 2x Extender
	Canon EF 70-300mm f/4.5-5.6 DO IS USM
	Canon EF 70-300mm f/4-5.6L IS
	Canon EF 70-300mm f/4-5.6L IS USM
	Canon EF 85mm f/1.2L II
	Canon EF 85mm f/1.8 USM
	Canon EF 100mm f/2.0 USM
	Canon EF 100mm f/2.8L Macro IS USM
	Canon EF 100-400mm f/4.5-5.6L IS
	Canon Zoom EF 100-400mm f/4.5L IS with 1.4x Extender
	Canon Zoom EF 100-400mm f/4.5L IS with 2x Extender
	Canon EF 100-400mm f/4.5-5.6L IS II USM
	Canon EF 135mm f/2.0L
	Canon EF 135mm f/2.0 L with 1.4x Extender
	Canon EF 135mm f/2.0 L with 2.0x Extender
	Canon EF 135mm f/2.8 Soft Focus
	Canon EF 180mm f/3.5L Macro
	Canon EF 180mm f/3.5L Macro with 1.4x Extender
	Canon EF 180mm f/3.5L Macro with 2x Extender
	Canon EF 200mm f/2.0L IS
	Canon EF 200mm f/2.0L IS with 1.4x Exender
	Canon EF 200mm f/2.0L IS with 2x Extender
	Canon EF 200mm f/2.8L II
	Canon EF 200mm f/2.8L II with 1.4x Extender
	Canon EF 200mm f/2.8L II with 2x Extender
	Canon EF 200-400mm f/4L IS USM
	Canon EF 200-400mm f/4L IS USM 1.4x Extender
	Canon EF 300mm f/2.8
	Canon EF 300mm f/2.8L IS
	Canon EF 300mm f/2.8L IS II USM
	Canon EF 300mm f/2.8L IS with 1.4x Extender
	Canon EF 300mm f/2.8L IS with 2x Extender

DSMC2 MONSTRO OPERATION GUIDE

COMPATIBLE LENS TYPE	FOCAL LENGTH
Canon EF	Canon EF 300mm f/2.8L IS II USM with 1.4x III Extender
	Canon EF 300mm f/2.8L IS II USM with 2x III Extender
	Canon EF 300mm f/4L IS
	Canon EF 300mm f/4.0 L IS with 1.4x Extender
	Canon EF 300mm f/4.0 L IS with 2.0x Extender
	Canon EF 400mm f/2.8
	Canon EF 400mm f/2.8 IS II USM
	Canon EF 400mm f/2.8L IS
	Canon EF 400mm f/2.8L IS with 1.4x Extender
	Canon EF 400mm f/2.8L IS with 2x Extender
	Canon EF 400mm f/4.0 DO IS
	Canon EF 400mm f/4.0 DO IS with 1.4x Extender
	Canon EF 400mm f/4.0 DO IS with 2x Extender
	Canon EF 400mm f/5.6L
	Canon EF 400mm f/5.6L with 1.4x Extender
	Canon EF 400mm f/5.6L with 2x Extender
	Canon EF 500mm f/4L IS
	Canon EF 500mm f/4L IS USM
	Canon EF 500mm f/4L IS II USM
	Canon EF 500mm f/4L IS with 1.4x Extender
	Canon EF 500mm f/4L IS with 2x Extender
	Canon EF 500 f/4L IS II USM
	Canon EF 600mm f/4L IS
	Canon EF 600mm f/4L IS II USM
	Canon EF 600mm f/4L IS with 1.4x Extender
	Canon EF 600mm f/4L IS with 2x Extender
	Canon EF 800mm f/5.6L IS
	Canon EF 800mm f/5.6L IS with 1.4x Extender
	Canon EF 800mm f/5.6L IS with 2x Extender

DSMC2 MONSTRO OPERATION GUIDE

COMPATIBLE LENS TYPE	FOCAL LENGTH
Canon EF-S	Canon EF-S 10-18mm f/4.5-5.6 IS STM ²
	Canon EF-S 10-22mm f/3.5-4.5 USM ²
	Canon EF-S 15-85mm f/3.5-5.6 IS USM
	Canon EF-S 17-55mm f/2.8 IS USM
	Canon EF-S 18-55mm f/3.5-5.6 IS ²
	Canon EF-S 18-55mm f/3.5-5.6 IS II
	Canon EF-S 18-135mm f/3.5-5.6 IS STM ²
	Canon EF-S 18-200mm f/3.5-5.6 IS
	Canon EF-S 24mm f/2.8 STM
Canon EF-S 60mm f/2.8 Macro USM	
Sigma	Sigma 10-20mm f/3.5 EX DC HSM
	Sigma 14mm f/1.8 DG HSM Art
	Sigma 14-24mm f/2.8 DG HSM Art
	Sigma 15mm f/2.8 EX DG Diagonal Fisheye
	Sigma 17-70mm f/2.8-4 DC Macro OS HSM
	Sigma 18-35mm f/1.8 DC HSM Art
	Sigma 20mm f/1.8 EX DG ASP RF
	Sigma 24mm f/1.8 EX DG ASP Macro AF
	Sigma 24-35mm f/2 DG HSM Art
	Sigma 24-70mm f/2.8 IF EX DG HSM
	Sigma 24-105mm f/4 DG OS HSM
	Sigma 28mm f/1.8 EX DG ASP Macro AF
	Sigma 50mm f/1.4 EX DG HSM
	Sigma 50-100mm f/1.8 DC HSM Art
	Sigma 70mm f/2.8 DG Macro Art
	Sigma 85mm f/1.4 EX DG HSM
	Sigma 105mm f/1.4 DG HSM Art
Sigma 120-300mm f2.8 DG OS HSM ²	
Sigma APO	Sigma APO 50-150mm f/2.8 EX DC HSM II
	Sigma APO 70-200mm f/2.8 EX DG HSM ²
	Sigma APO 70-200mm f/2.8 EX DG Macro HSM II
	Sigma APO 120-300mm f/2.8 EX DG OS HSM
	Sigma APO 180mm f/2.8 Macro EX DG OS HSM
Tamron®	Tamron 28-300mm f3.5 Macro
	Tamron 28-300mm f/3.5 XR Di VC LD Aspherical IF Macro
	Tamron 70-200mm f/2.8 Di LD IF Macro

DSMC2 MONSTRO OPERATION GUIDE

COMPATIBLE LENS TYPE	FOCAL LENGTH
Tamron SP	Tamron SP 10-24mm f/3.5-4.5 Di II LD Tamron SP 15-30mm f/2.8 Di VC USD ² Tamron SP 24-70mm f/2.8 Di VC USD Tamron SP 28-75mm f/2.8 XR Di LD Aspherical IF Macro Tamron SP 70-200mm f/2.8 Di VC USD ² Tamron SP 150-600mm f/5 USD Di ² Tamron SP 200-500mm f/5 Di LD IF
Tokina	Tokina AT-X 116 Pro DX, 11-16mm f/2.8 SD IF DX Tokina AT-X 116 Pro DX-II, 11-16mm f/2.8 SD IF DX
Zeiss Distagon®	Zeiss Distagon T* 15mm f/2.8 ZE Zeiss Distagon T* 18mm f/3.5 ZE Zeiss Distagon T* 21mm f2.8 ZE Zeiss Distagon T* 25mm f/2 ZE Zeiss Distagon T* 28mm f/2 ZE Zeiss Distagon T* 35mm f2 ZE
Zeiss Makro-Planar®	Zeiss Makro-Planar T* 100mm f/2 ZE
Zeiss Otus®	Zeiss Otus 55mm f/1.4
Zeiss Planar	Zeiss Planar T* 50mm f1.4 ZE Zeiss Planar T* 85mm f1.4 ZE

1. The camera displays lens information when the lens is in manual mode. Focus, iris, zoom, and image stabilization (IS) are not supported.
2. Image stabilization (IS) is not supported.

DSMC2 MONSTRO OPERATION GUIDE

NIKON F-MOUNT LENSES

This section describes the appropriate method for attaching and detaching Nikon® F-Mount lenses. For more information, refer to the original manufacturer's instructions. This section also lists lenses supported by the DSMC Nikon F-Mount.

WARNING: ALWAYS protect your equipment, when it is not in use, by replacing lens caps and mount caps.

ATTACH NIKON F-MOUNT LENSES

1. Rotate the secondary locking ring counter-clockwise to disengage.
2. Press the lens release button and rotate the lens cap clockwise to remove the camera mount cap.
3. Remove the rear lens cap.
4. Align the mounting index (white dot) on the lens with the mounting index on the DSMC Nikon mount and position the lens in the bayonet mount.
5. Rotate the lens counter-clockwise until it clicks into place, being careful to NOT press the lens release button.
6. Rotate the secondary locking ring clockwise to engage.

DETACH NIKON F-MOUNT LENSES

1. Rotate the secondary locking ring counter-clockwise to disengage.
2. Press and hold the lens release button. While holding the lens release button, turn the lens clockwise until it stops and remove it from the camera mount.
3. Replace the rear lens cap and camera mount cap when items are not in use.

DSMC NIKON MOUNT SUPPORTED LENSES

The DSMC Nikon Mount electronically supports the following lenses:

COMPATIBLE LENS TYPE	FOCAL LENGTH
Nikkor AF	AF Nikkor 28mm f/2.8D
	AF Nikkor 50mm f/1.8D
	AF DX Fisheye-Nikkor 10.5mm f/2.8G ED
	AF Fisheye-Nikkor 16mm f/2.8D
	AF Nikkor 35mm f/2D
	AF Nikkor 50mm f/1.4D ^{1, 2}
	AF Nikkor 85mm f/1.4D IF
	AF Nikkor 200mm d/1.4D ED Micro

DSMC2 MONSTRO OPERATION GUIDE

COMPATIBLE LENS TYPE	FOCAL LENGTH
Nikkor AF-S	AF-S Nikkor 10-24mm f/3.5-4.5G ED DX
	AF-S Nikkor 12-24mm f4G ED DX
	AF-S Nikkor 14-24mm f/2.8G ED
	AF-S Nikkor 17-35mm f/2.8D ED IF
	AF-S Nikkor 17-55mm f/2.8G ED DX
	AF-S Nikkor 20mm f/1.8G ED N
	AF-S Nikkor 24mm f/1.4G ED
	AF-S Nikkor 24-70mm f/2.8G ED
	AF-S Nikkor 35mm f/1.4G
	AF-S Nikkor 50mm f/1.4G
	AF-S Nikkor 70-200mm f/2.8E FL ED VR
	AF-S Nikkor 70-200mm f/2.8G ED VR II
	AF-S Nikkor 80-400mm f/4.5-5.6G ED N ¹
	AF-S Nikkor 85mm f/1.4G
	AF-S Nikkor 200-400mm f/4.0G ED VR II
	AF-S Nikkor 200-500m f/5.6E ED VR ³
	AF-S Nikkor 300mm f/4E PF ED VR
	AF-S Nikkor 600mm f/4G ED VR N
	AF-S DX Micro-Nikkor 40mm f/2.8G
	AF-S Micro-Nikkor 60mm f/2.8G ED
AF-S Micro-Nikkor 105mm f/2.8G VR IF-ED	
Sigma	Sigma 12-24mm f/4 DG HSM Art
	Sigma 14mm f/1.8 DG HSM Art
	Sigma 17-50mm f/2.8 EX DC OS HSM
	Sigma 17-70mm f/2.8-4 DC Macro OS HSM
	Sigma 18-35mm f/1.8 DC HSM
	Sigma 20mm f/1.4 DG HSM Art
	Sigma 24mm f/1.4 DG HSM Art
	Sigma 24-35mm f/2 DG HSM Art
	Sigma 24-70mm f/2.8 EX DG HSM
	Sigma 24-105mm f/4 DG OS HSM
	Sigma 35mm f/1.4 DG HSM Art
	Sigma 50mm f/1.4 DG HSM Art
	Sigma 50-100mm f/1.8 DC HSM Art
	Sigma 85mm f/1.4 DG HSM Art
	Sigma 120-300mm f/2.8 DG OS HSM

DSMC2 MONSTRO OPERATION GUIDE

COMPATIBLE LENS TYPE	FOCAL LENGTH
Sigma APO	Sigma APO 70-200mm f/2.8 DG OS HSM Sigma APO 120-300mm f/2.8 EX DG OS HSM
Tamron	Tamron SP 24-70mm f2.8 Di VC USD
Tokina	Tokina AT-X 107 DX, 10-17mm f/3.5-4.5 Fisheye DX Tokina AT-X 116 Pro DX, 11-16mm f/2.8 SD IF DX Tokina AT-X 116 Pro DX-II, 11-16mm f/2.8 SD IF DX
Zeiss Distagon	Zeiss Distagon T* 21mm f/2.8 ZF.2 Zeiss Distagon T* 35mm f/1.4 ZF.2
Zeiss Otus ^{1, 2}	Zeiss Otus 55mm f/1.4 ^{1, 2} Zeiss Otus 85mm f/1.4 ZF.2 APO ¹
Zeiss Planar	Zeiss Planar T* 50mm f/1.4 ZF.2 Zeiss Planar T* 85mm f/1.4 ZF.2

1. Iris control only, no AF.
2. No hand controller support.
3. Set the VR switch on the lens to OFF when installing the lens. Also, Nikon has issued an advisory for the AF-S Nikkor 200-500mm f/5.6E ED VR lens. For more information, go to https://www.nikonimgsupport.com/ni/NI_article?lang=en_US&articleNo=000004723.

DSMC2 MONSTRO OPERATION GUIDE

AL LEICA-M MOUNT LENSES

This section describes the appropriate method for attaching and detaching Leica-M[®] lenses. For more information, refer to the original manufacturer's instructions. This section also lists lenses supported by the DSMC AL Leica-M Mount.

WARNING: ALWAYS protect your equipment, when it is not in use, by replacing lens caps and mount caps.

ATTACH LEICA-M LENSES

1. Rotate the locking ring counter-clockwise to release the camera mount cap.
2. Remove the rear lens cap and the camera mount cap.
3. Align the mounting index (white dot) on the lens with the mounting index on the DSMC AL Leica-M mount.
4. Insert the lens into the DSMC AL Leica-M mount.
5. Rotate the locking ring clockwise to secure the lens in place.

DETACH LEICA-M LENSES

1. Rotate the locking ring counter-clockwise to release the Leica-M lens.
2. Remove the Leica-M lens from the DSMC AL Leica-M mount.
3. Replace the rear lens cap and camera mount cap when the lens is not in use.

DSMC AL LEICA-M MOUNT SUPPORTED LENSES

The DSMC AL Leica-M Mount is compatible with most Leica M-series lenses with focal lengths of 50mm and greater, EXCEPT for the 50mm f2.0 Dual-Range Summicron. The 50mm f2.0 Dual-Range Summicron has a protruding lug on the exterior of the lens body for mounting a supplementary finder. This lug interferes with the locking ring on the DSMC AL Leica-M Mount. Most Leica lenses with focal lengths of less than 50mm will encounter mechanical interference between the rear lens cell and the camera's front panel.

WARNING: Attempting to mount Leica lenses of focal lengths of less than 50mm could result in damage to the lens and/or the camera.

APPENDIX E:

DEFAULT KEY FUNCTIONS

NOTE: If using a third-party module, the default GPI functions may match the inputs offered by the module (instead of the RED defaults).

DEFAULT KEYS

ITEM	KEY	FUNCTION
Camera BRAIN®	Record Full Press	Record: Toggle
	GPI In High	Record: Start
	GPI In Low	Record: Stop
Media Bay (Side SSD)	Record Full Press	Record: Toggle/Multi-Shot Start
	Record Full Release	Record: Multi-Shot Stop
	Record Half Press	AF: Start
	User 1+2 Press	Eject Media
LCD (Primary and Secondary)	Up Press	Br. Up (Increase Brightness)
	Down Press	Br. Down (Decrease Brightness)
	User 1 Press	Magnify: Toggle
	User 2 Press	Exposure Check: Toggle
	User 1+2 Press	LCD: Toggle Lock
EVF (Primary and Secondary)	User 1 Press	Magnify: Toggle
	User 2 Press	Exposure Check: Toggle

DSMC2 MONSTRO OPERATION GUIDE

ITEM	KEY	FUNCTION
DSMC2® SIDEKICK™	User A Press	AF Mode: Cycle
	User B Press	WB: Auto Calc
	User C Press	Magnify: Toggle
	User D Press	Exposure Check: Toggle
	User A+D Press	SM: Toggle Key Lock
	Nav Menu Press	Navigation: Menu
	Nav North Press	Navigation: Up
	Nav South Press	Navigation: Down
	Nav East Press	Navigation: Right
	Nav West Press	Navigation: Left
	Nav Enter Press	Navigation: Select
	Rotary CW	Navigation: CW
	Rotary CCW	Navigation: CCW

DSMC2 MONSTRO OPERATION GUIDE

ITEM	KEY	FUNCTION
DSMC2 Side Handle	User A Press	AF Mode: Cycle
	User B Press	WB: Auto Calc
	User C Press	Magnify: Toggle
	User D Press	Exposure Check: Toggle
	Nav Menu Press	Navigation: Menu
	Nav North Press	Navigation: Up
	Nav South Press	Navigation: Down
	Nav East Press	Navigation: Right
	Nav West Press	Navigation: Left
	Nav Enter Press	Navigation: Select
	Rotary Side CW (Iris Control Wheel)	Iris: Open
	Rotary Side CCW (Iris Control Wheel)	Iris: Close
	User 1 Press (Mark Frame)	Record: Mark Frame
	Record Half Press	AF: Start
	Record Half Release	Key Disabled
	Record Full Press	Record: Toggle/Multi-Shot Start
	Record Full Release	Record: Multi-Shot Stop
Focus Control Wheel CW ¹	Increase focus distance	
Focus Control Wheel CCW ¹	Decrease focus distance	
DSMC2 Top Handle	Record Full Press	Record: Toggle/Multi-Shot Start
	Record Full Release	Record: Multi-Shot Stop
DSMC2 Outrigger Handle	Record Full Press	Record: Toggle/Multi-Shot Start
	Record Full Release	Record: Multi-Shot Stop

1. The Focus Control Wheel is NOT programmable; it cannot be mapped to another function.

DSMC2 MONSTRO OPERATION GUIDE

APPENDIX F: MENU MAP

